

# Best Practices for Higher Education Facility Design: Safety Security Resilience Preparedness



JUNE 2022



# Best Practices for Higher Education Facility Safety, Security, and Preparedness Design

The following best practices for facility design relate to physical security, occupant safety, emergency preparedness, and an all-hazards mitigation strategy.

This document presents a series of concepts that may be applied to the unique circumstances for any individual site or building. It is a reference guide for campus facilities planning teams, architects, and contractors involved in the design, construction, and operation of State of Tennessee higher education campus projects.

These guidelines may be updated from time-to-time as best practices continue to evolve. As a user, please reference the most current document available, and verify that the project design is in alignment with locally adopted codes and permitting requirements. These concepts are intended as guidelines through the design process and should not conflict with or override code or life safety requirements.

The recommendations were derived from best practices and overall facility security assessment criteria developed by the Tennessee Department of Safety and Homeland Security (TDOSHS), and reviewed (for informational purposes only) by the Office of the State Architect, (OSA), and the Tennessee Emergency Management Agency (TEMA), and THEC Facilities Planning. We believe the use of these design parameters, whether in capital projects or local initiatives, will serve to improve the safety, security, and resilience of all campus communities.

Current best practices have identified the most effective time to increase the overall safety and resilience of any constructed asset is during the site selection and design phases. This applies to buildings, landscape projects, and infrastructure installations. In order to make any project as safe and resilient as possible (as well as cost-effective), it is recommended that the entire stakeholder team should convene as early as possible in the project programming or design phase to identify:

- A. The site-specific threats the owner intends for the design and construction team to address.
- B. The overall threat level and security level required for each unique project.
- C. The mission criticality rating of the project to be constructed or renovated.
- D. The iconic symbolism of the project.
- E. The maximum anticipated facility population.
- F. Any intangible factors that may increase or decrease the possible threat level.

It is recommended that this group should consist of the owner, designer and consultants, security, emergency management consultants, and a construction representative at a minimum.

Based on recommendations from TDOSHS and TEMA the document is organized as follows:

1. Strategic Security Concepts
2. Site & Structure Security
3. Interior Security
4. Security Systems
5. Security Operations
6. Emergency Preparedness
7. Blast Mitigation Design
8. Non-Invasive Physical Security



# SECTION 1. INTRODUCTORY CONCEPTS FOR SAFETY, SECURITY, and PREPAREDNESS

## SHARED RESPONSIBILITY FOR FACILITY SAFETY AND SECURITY

All users of a facility should view themselves as responsible for site and building safety and security. An additional level of responsibility falls on those involved in the design, construction, and operation of facilities. As an architect or engineer, there is a professional responsibility to ensure that all measures are taken to design a facility that is safe and secure. It is reasonable to expect that a facility will offer protection from the elements, be structurally sound, and provide the occupants with a healthy indoor environment. Designing with an “all-hazards” mindset may bring strategies and solutions that allow a design to meet all the programmatic requirements along with a significantly more prepared facility.

Contractors and sub-contractors should understand why certain specified materials and details will provide protection from emerging threats. Maintenance and operations personnel should understand the concepts for the facility design, and users need to be trained in safety policies and procedures. This all-hazards mindset should apply to everyone involved in the development and use of the facility.

## FUNDAMENTALS OF CRIME PREVENTION THROUGH ENVIRONMENTAL DESIGN (CPTED)

CPTED has been used for decades to integrate the fundamental concepts of neighborhood, site and building security into an understandable set of practical decisions.

At a high level, the **four primary CPTED concepts** are:

### Natural Surveillance -

- Increases visibility within and around a building or site
- Provides clear visibility from inside the building to the exterior and from the outside the building into the interior
- This allows legitimate users of the facility and surrounding properties to act as responsible guardians

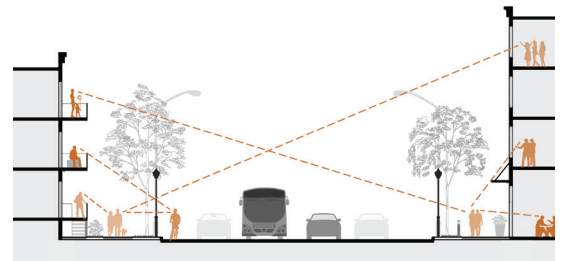

Image: Minneapolis 2040

### Natural and Mechanical Access Control-

- Creates a real and perceived boundary to deny access to targeted property
- Spatial and circulation patterns can create naturally occurring features to control access
- Deny ease of access to commit a crime or to prevent escape if a crime is committed



Natural access control site design

### Territorial Reinforcement (Section 1, Concept D)-

- Establish a clear sense of ownership by legitimate users and occupants
- Encourages users to challenge unknown persons or unauthorized activity
- Human means of formalizing this are: watch groups, neighborhood watch, etc...
- Mechanical means to accomplish this may be items such as motion sensors, cameras, and lighting



Easily recognized boundary definition

## Management and Maintenance-

- Spaces must be maintained to an appropriate standard to reflect the building use and importance
- Properly maintained landscape and building exterior demonstrate that the property is cared for and that any irregularity will quickly be noticed and addressed (broken window theory)
- Overlaps with the concept of access control by making anything out-of-place stand out so that legitimate users can easily identify it and investigate.



Run-down, poorly maintained



Well maintained property

## CONCENTRIC LAYERS OF SECURITY

The entire site may be viewed as a single entity with multiple layers of protection. This is referred to as Concentric layers of Protection or Security. Each layer builds on the one prior to it. The site may have no fencing but only a change in landscaping to identify a boundary. However, the buildings may have access control or cameras to offer a higher level of security. The offices within the building may have biometric locking or multi-layer verification necessary to enter sensitive areas. In this way, each layer combines to create increasing safety and security. Additionally, each layer presents an opportunity to prevent unauthorized access. Each layer of security that is added also gives more time for responders to reach the scene in case of a breach in security.

In relation to weather, this applies to building materials and methods of construction to create sheltered spaces within these facilities. Having multiple layers eliminates the need to depend on one layer to provide total security as well as providing a redundant layer in case the outer layer is compromised.

If programmatic requirements demand that one of these layers is reduced in effectiveness (such as an all-glass wall looking into a classroom instead of a solid wall), the other combined layers of security must make up for this shortfall and still provide the same net level of security.

## SECTION 2. EXTERIOR BUILDING SAFETY AND SECURITY DESIGN CONCEPTS

### A. ELIMINATION OF ENTRAPMENT AREAS

Entrapment areas are small, confined areas near or adjacent to well-traveled routes that are shielded on three sides by some barriers, such as walls or bushes.

Examples are elevators, tunnels, or bridges, enclosed and isolated stairwells, dark recessed entrances that may be locked at night, gaps in tall vegetation, narrow deep recessed area for a fire escape, etc. Parking lots and buildings isolated by open spaces can also become entrapment areas, especially when there is less activity after operating hours. Any entrapment areas should be eliminated. If elimination of an entrapment area is not possible, it should be locked or closed after operating hours. For instance, a passageway connection to a locked building should be locked as well. It is preferable to have natural surveillance.

If an entrapment area is unavoidable, the area should be well lit with some form of formal surveillance. In the case of elevators, incorporation of glass windows in the design of elevators doors could be helpful. If blind spots cannot be eliminated, the use of security mirrors, security cameras, or other security devices are not optimal but may be necessary.

### B. LIGHTING - GENERAL DESIGN CONCEPTS

- i. **PLACEMENT** - Consider the overall shape of the building perimeter to include alcoves, parapet or eave height, or any other building element that could produce shadowed areas. Lighting should also be directed on roadside pavement and possible entrapment spaces other than on roads. Lighting should consider vegetation, such as mature trees, and other obstructions that would cause light to be blocked off.
- ii. **CONSISTENCY** - Lighting should be uniformly spread to reduce contrast between shadows and illuminated areas. The use of more fixtures with lower wattage, rather than fewer fixtures with higher wattage, helps reduce deep shadows and avoid excessive glare. Lighting of common areas such as corridors, lobbies and stairwells should be sufficient, and areas of shadows should be avoided. Parking areas and building access points should be visible and well lit.
- iii. **VANDAL RESISTANCE** - Exterior lighting needs to be high enough to provide clear and unobstructed lighting. The lighting height should limit access to ladders thereby reduces the possibility of illegitimate tampering. Specify vandal-resistant lenses to further mitigate tampering.

This image shows the worst case scenario for an entrapment area. Avoid configurations that create hidden areas such as this.

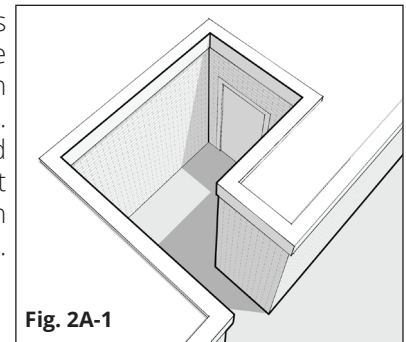

This image shows a better solution but still not an optimal configuration. Cameras, lighting, and after-hours gate to prevent entry into this dead-end corridor would be better.

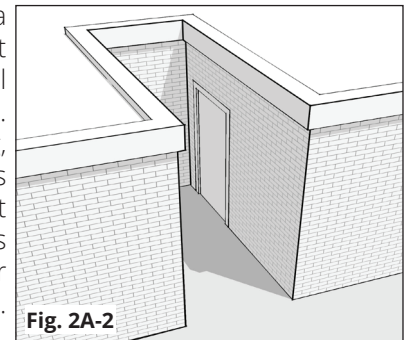

A surface-mounted door cannot create any entrapment area. This is shown to provide obvious contrast between the two images above.

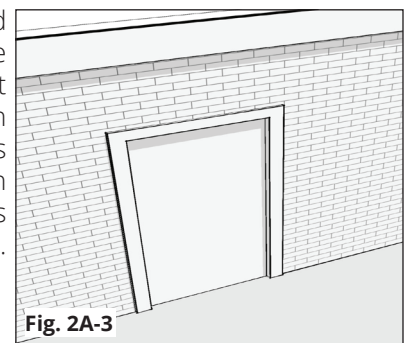

## Additional Vandal Resistant Lighting Guidance

- Resists penetration and contraband concealment
- Impact resistant and close-fitting lenses
- Lamps & ballasts positioned away from impact zones
- Shielded lamps
- Concealed or tamper resistant hardware
- 4-point mounting to junction box
- Gasketing
- Marine grade housing materials
- Vibration absorbing sockets for HID lamps
- Suitable IP Rating

iv. **CAMERA COMPATIBILITY** - Ensure that all building entrances/ exits are illuminated with footcandles adequate to provide high resolution camera capability. Lighting should be of a type that is compatible with most commonly used security/surveillance camera types, specifically when considering the cameras systems low light capabilities. Some lighting types do not portray colors and or details accurately under these conditions (spectral range). In security applications a color rendering index (CRI) of 80 or higher is generally appropriate. The designer should review each specific application. Additional consideration should be given to the minimum illumination requirements for the security/surveillance camera system being used.

v. **PREVENT TEMPORARY NIGHT BLINDNESS** - Balance interior footcandle levels near egress points with the footcandle levels of exterior lighting adjacent to egress points. Varying lighting levels can cause users entering or exiting to be temporarily 'blinded' or unable to see due to suddenly reduced light levels. This can occur from:

- Incorrectly positioned lights that cause glare (angle, height, reflector direction, color temperature)
- Light levels being significantly different from one area to another

Fig. 2B-1

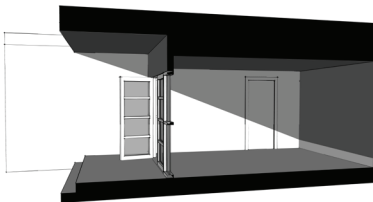

Exterior lighting is excessive and creates perceptually dark area inside. This produces glare when transitioning to the exterior.

Fig. 2B-2

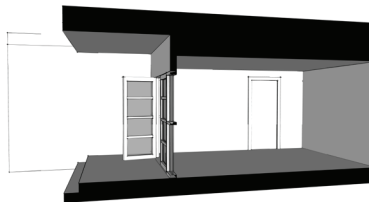

Exterior and interior light levels are nominally balanced. This creates a safer transition for occupants since they do not experience glare or nightblindness.

Fig. 2B-3

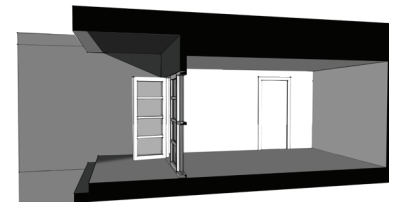

Interior lighting is excessive compared to exterior light levels. This creates temporary nightblindness when transitioning to the exterior.

vi. **SITE PLANNING** -

Use a light distribution plan to ensure that the building perimeter, all pedestrian pathways, parking lots, fences, athletic fields, or other areas that could provide an unauthorized individual to hide in darkness are illuminated with levels approved by IES to provide for individual safety as well as proper camera resolution. Generally, illumination levels should allow for positive ID of persons 30 feet from viewer and have a 4:1 luminance ratio background-to-face – avoiding silhouettes.

vii. **EASE OF MAINTENANCE** -

Lighting requires maintenance to preserve visibility. Bushes and trees that block off light should be trimmed (see Fig. 2C-2). Lighting fixtures should be located at suitable heights for easy maintenance and replacement. Light fixtures should be maintained in a clean condition and promptly replaced if burnt or broken. Posting information indicating who to call in case of burnout or vandalized lights is desirable.



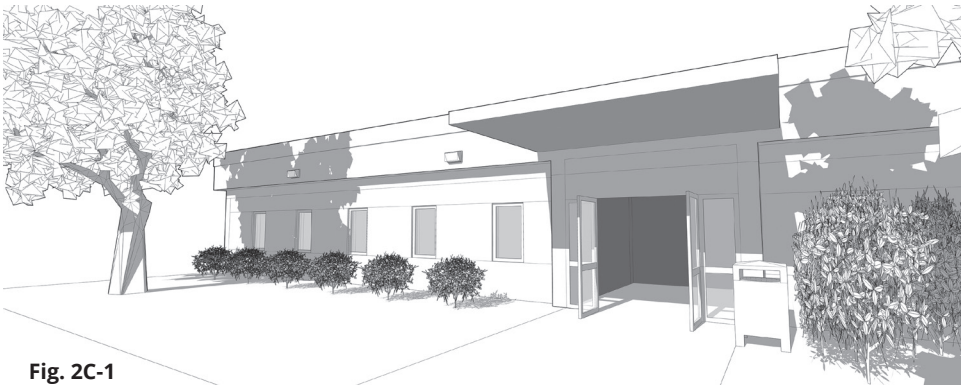

Fig. 2C-1

**Good landscaping:** bushes are low and the tree is cut high enough to allow good visibility inside and out. The bushes are far enough from the building to prevent anyone from hiding between them and the building. The absence of landscaping immediately adjacent to the door is a recommended strategy. The tree is cut back far enough to prevent access to the roof.

**Unsafe landscaping:** bushes to the right of the door are too tall and dense to allow visibility in or out of the windows. The tree is too close to the building and provides easy climbing access onto the roof. The overgrown bushes also provide an area where criminals could hide themselves or contraband. The bushes prevent easy access to maintain the exterior lighting. The trash receptacle is too close to the doors and could hide contraband or explosives.



Fig. 2C-2

## C. LANDSCAPING

- i. Do not plant vegetation in such a way that after years of growth, shrubs and/or trees will grow to touch the walls of the building. This can produce areas where unauthorized items can be hidden, or individuals can hide out of view of users and security cameras. This provides for what is called 'natural surveillance'. (Fig. 2C-2)
- ii. Location and landscaping of open spaces should be such that it encourages natural surveillance from surrounding buildings and streets. Trees and hedges along public or secondary roads should not obstruct visibility from buildings. Hedges (if necessary) should not become convenient hiding spaces and could be spaced out to avoid total visual obstruction. This also applies to internal landscaping. Landscaping elements should be chosen and maintained so that they do not block light.
- iii. Create a plan for trimming to keep shrubs lower than 2' and tree limbs higher than 6'. This ensures that legitimate users either inside the building looking out or outside of the building looking towards the building have a clear field of view in the most likely area where unauthorized personnel would try and hide or gain unauthorized access to the building.
- iv. Do not plant trees close enough to a building so that after years of growth they might provide unauthorized access onto the roof or other parts of the structure.
- v. If there are areas where landscaping must be used near a building or structure, specify plantings that produce thorns or spikes in order to create inhospitable places to prevent concealment of potential criminals.

## D. TERRITORIAL REINFORCEMENT

- i. People naturally protect a territory that they feel is their own and have a certain respect for the territory of others. Clear boundaries between public and private areas express ownership, and can be achieved by using physical elements such as fences, pavement treatment, art, signs, good maintenance, and landscaping. It is easier to identify intruders in such well-defined spaces. Territorial reinforcement can be seen to work when a space, by its clear legibility, transparency, and directness, discourages potential offenders because of users' familiarity with each other and the surroundings.



This image (although an overly simplified building) shows the basic concepts of territorial reinforcement. There is a clear distinction between the public space (the street), the semi-private space (the sidewalk), and the private space (everything enclosed within the clear boundary of the fencing). The building has a sense of being well-maintained by the users and does not present trespassers an easy way to make an excuse should they be challenged.

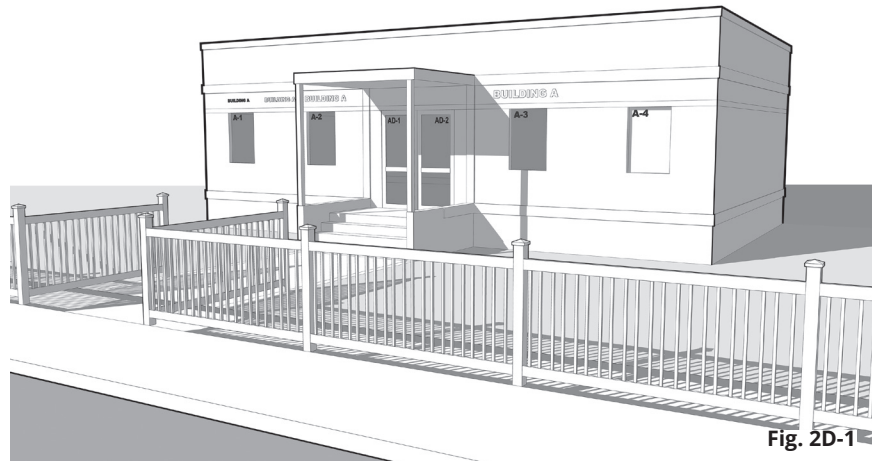

Fig. 2D-1

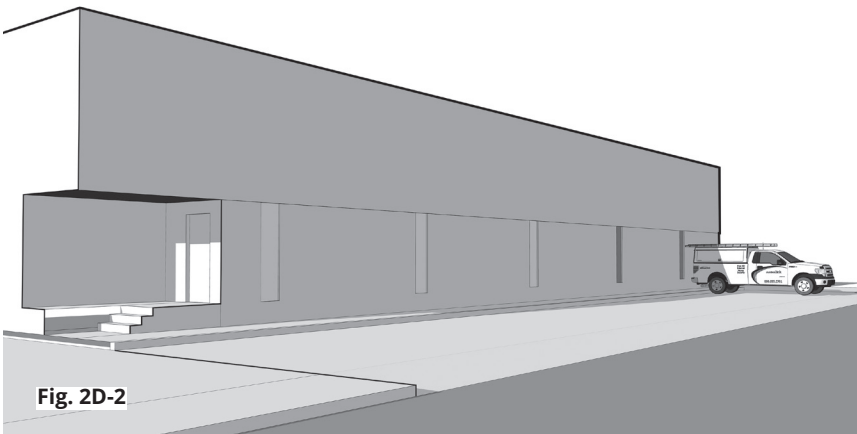

Fig. 2D-2

This image shows a building that does not exhibit good territorial reinforcement. The building faces onto a public street without any clear definition of where the property line starts or stops. There is not a clear public/private boundary. The entrance is not clearly visible from the street and trespassers could easily be on private property without appearing out of place.

## E. INGRESS/EGRESS

- i. Entrance areas to individual buildings should be clearly visible from adjacent streets and buildings (Fig. 2D-1).
- ii. Limit the points of entry into or out of the building to the minimum required for proper use by program and occupant count. Access control hardware is recommended for these ingress/egress points. (Fig. 2E-1)
- iii. If additional exterior doors must be added for egress, it is recommended to limit those additional doors to exit only (Fig. 2E-1). These may have door hardware with either no exterior key access or have key access but are unable to be 'unlocked' and have self-closers installed with annunciation if not shut properly.
- iv. Minimize glazing in entrances to amount necessary to provide clear view into and out of the building and align with the overall aesthetics of the building. If additional large panes of glass are mandated by the program, it is recommended to utilize glass retention film or laminated glass at these key entrance points to prevent easy unauthorized intrusion. Consider mullions or sills at heights that will deter or slow down unauthorized ingress.
- v. Whenever possible at primary building entrances, utilize a vestibule with interior access control and camera coverage (Fig. 2E-2).
- vi. If overhangs, porticos, or other overhead coverings are present at entrances, do not allow trash containers or other fixtures that could conceal hazardous items to be located beneath these overhead structures.

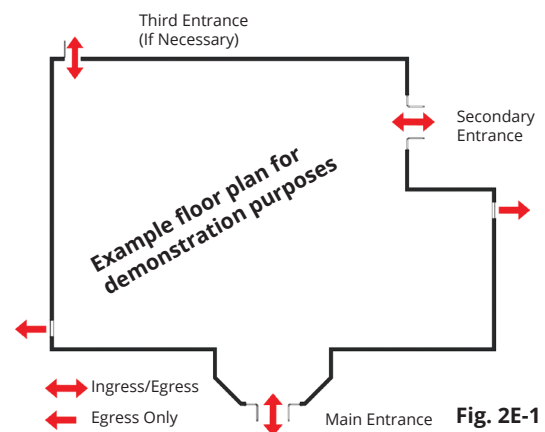
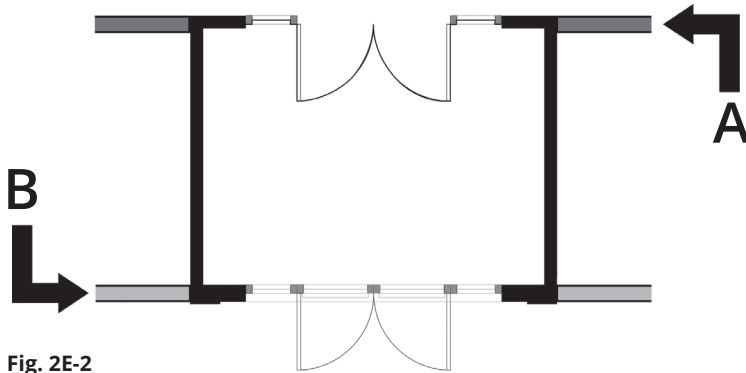

Fig. 2E-1

- vii. Use 6" reflective lettering to identify each exterior door using a campus wayfinding standard to indicate building and door number. This allows for any first responder to immediately navigate to individual doors in case of imminent emergency or other response, regardless of whether or not campus personnel are present. Utilizing reflective lettering allows for quick visual acquisition at night. (Fig. 2D-1)
- viii. Utilize bollards, planters, or other immovable objects specifically designed to prevent unauthorized or unintentional vehicle ingress at entrances adjacent to parking lots or pedestrian walkways.



The image to the left shows a typical vestibule in two configurations. If the exterior wall is at location **A**, then the inner set of doors should remain locked and the vestibule construction should be decoupled from the primary building structure to avoid potential progressive collapse. If the exterior wall is at location **B**, then the exterior set of doors should remain locked along with the interior set.

Fig. 2E-2

### SECTION 3. INTERIOR SAFETY AND SECURITY DESIGN CONCEPTS

#### A. CORRIDORS (Figs. 3A-1 - 3A-3)

- i. Whenever practical and allowed by code (based on occupant count, etc...) utilize outswing doors into corridors or from the interior to the exterior of the building. The rationale behind this recommendation is that outswing doors are significantly more difficult to breach by unauthorized users of the facility than and inswing door that can be breached with comparative ease.
- ii. Whenever possible avoid alcoves or other areas of concealment within regularly occupied spaces. If an alcove is necessary, such as to allow for egress width in corridors (with outswing doors) then minimize the depth of the alcove as much as possible (see corridor floor plans below).

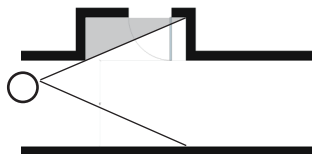

Fig. 3A-1

This corridor configuration allows for minimum corridor egress width but sacrifices safety by creating a location, in the shaded space, that is visually hidden from public safety personnel moving along the corridor.

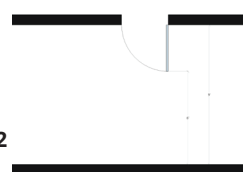

Fig. 3A-2

This corridor configuration, for public safety personnel, is visually the safest. However, it is the most expensive as it creates the widest corridor for the same egress width.

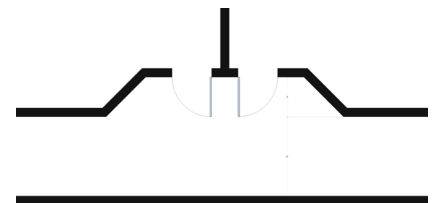

Fig. 3A-3

This corridor configuration is a hybrid between the two by minimizing corridor egress width but angling the walls to minimize visually hidden areas along the corridor.

- iii. The design and construction team must weigh the cost of a wider corridor against reductions in corridor egress width against the security problem presented by an alcove deep enough to allow for no intrusion by a door into the corridor.
- iv. The preferred wall material choice between corridors and classrooms or other occupiable spaces is masonry or other dense material that will offer greater ballistic protection than conventional gypsum board and stud partitions. Likewise, it is recommended that corridor walls extend vertically upwards to deck instead of allowing for a path of ingress from the corridor into the plenum space above adjacent spaces.

## B. RESTROOMS

- i. Restrooms should be well lit. Entrances should be highly visible and not tucked away in inconspicuous locations. Deep, contorted and recessed corridors leading to such facilities should be avoided. Entrances to restrooms near playgrounds should be visible from the playgrounds as far as possible. If there is more than one restroom (mens/womens), they should be located close to one another with clear sight lines.
- ii. When possible, utilize hard ceilings with lockable access panels. If the program or campus procedures do not allow this, consider using acoustic ceiling panel clips to prevent unauthorized access into the plenum space or utilize a ceiling height that makes it unlikely that users without a ladder can access the ceiling. A final option for this is to utilize no ceiling at all and instead have an exposed ceiling to deck to allow legitimate users easy visual access to see if contraband or other unauthorized items have been placed on elevated surfaces.
- iii. Utilize labyrinth entrance or, "lazy-S" design in multi-person restrooms. If this is not preferred, ensure that multi-person restrooms do not have door hardware which allows for locking from the interior.
- iv. In single-person restrooms, ensure that door hardware is able to be unlocked from the exterior with a building master key.

## C. CLASSROOMS/INTERIOR ROOMS

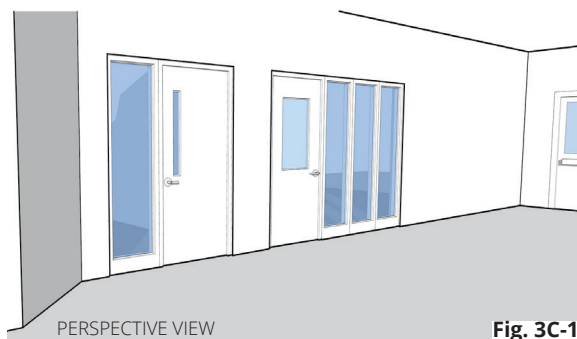

These two images show two classroom entries from two viewpoints. Take note of how little 'hard corner' (dark shading) is provided by the classroom with the wide expanse of glass adjacent to the door (Fig. 3C-2).

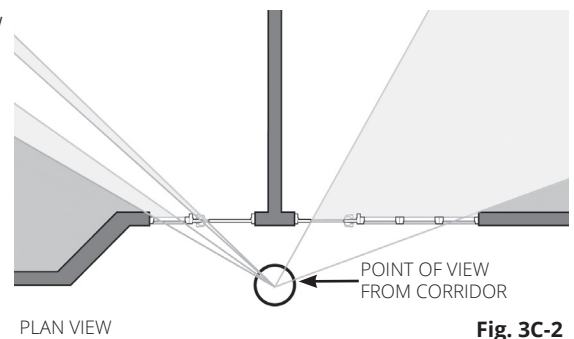

- i. **ROOM LAYOUT** - Interior rooms should be designed/setup with 'hard corners' in mind. Hard corners are areas in classrooms where persons would not be visible from hallways, windows, or door openings. Designers should layout the space for easy recognition of the hard corner during an emergency. Indicating the hard corner can be done by marking the floor, the wall, or a combination of the two. (Marking the hard corner should be consistent from room to room).
- ii. **CLASSROOM DOOR HARDWARE:**
  - Door hardware must comply with state and local building and fire codes as well as ADA requirements
  - Door hardware must allow for locking from within the classroom by a single motion, i.e.-Pushbutton on hardware or centralized access control point
  - Door must allow for free exit from the classroom by a single motion
  - Ensure that door vision panels are made from shatter-resistant glass or have glass retention film applied to one or both sides of the glazing.
  - Minimize the amount of glazing looking into classrooms to the extent that it does not interfere with the academic program. If large panes of glass are desired, ensure that there are still hard corners in the classroom sufficient to provide shelter for the occupant load of the classroom. Alternatively, utilize a strategy to allow for the interior glazing to be covered or occluded rapidly in case of a building-wide lockdown.
  - The door should be lockable from inside the classroom without requiring the door to be opened
  - Egress from the classroom through the classroom door should be possible without the use of a key, a tool, special knowledge, or effort
  - For egress, unlatching the classroom door from inside the classroom should be accomplished with one motion

- The classroom door should be lockable and unlockable from outside the classroom
- Door operating hardware should be operable without tight grasping, tight pinching, or twisting of the wrist
- Door hardware operable parts should be located between 34 and 48 inches above the floor
- The bottom 10 inches of the “push” side of the door surface should be smooth
- If the school building does not have an automatic fire sprinkler system, the classroom door and door hardware may be required to be fire-rated and the door should be self-closing and self-latching
- If the door is required to be fire-rated, the door should not be modified in any way that invalidates the required fire-rating of the door and / or door hardware
- It is important to resist the temptation to install door barricade devices. They have the potential to enable bullying, harassment, or worse when added to these public spaces.

**Fig. 3C-3**

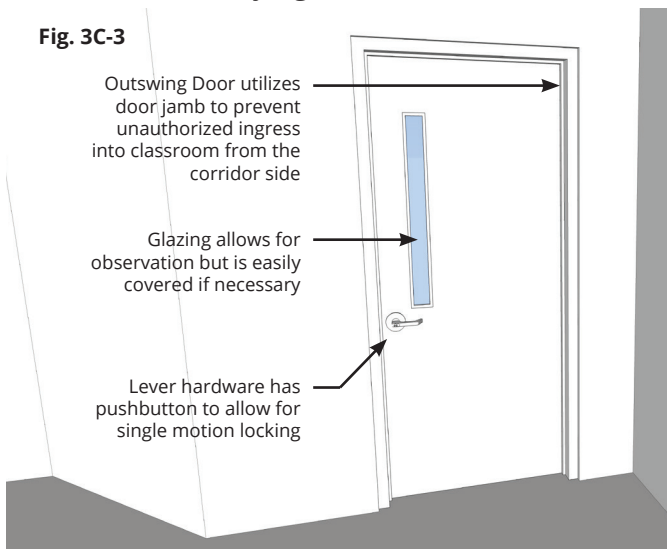

The image to the left shows the classroom side of a door leading onto a corridor. There are key things to notice in this image:

1. The door is an outswing door.
2. The lever hardware is a two-stage pushbutton for locking.
3. This pushbutton allows for the door to be quickly locked from within the classroom during a building lockdown. This removes the need for a door barricade device.
4. The lever hardware allows for one-motion exit.
5. The glass in the door is of sufficient size to allow for legitimate occupants to see into and out of the classroom under normal operation but is small enough to be quickly covered in case of a building lockdown.
6. The hard corner is visible to the left of the door.

### iii. CLASSROOM INTERIOR GLAZING

- Door glazing is to be made of shatter-resistant or laminated glass or have a glass-retention film applied to one or both faces.
- Interior glazing is to be made of shatter-resistant or laminated glass or have a glass-retention film applied to one or both faces.
- Minimize interior glazing to the least amount possible to still comply with academic requirements. If large panes of glass are required, avoid floor to ceiling panels whenever possible.
- When designing classrooms, regardless of how much glazing is intended, specify where a hard corner will be located out of sight of all access points into the classroom and ensure that it is large enough to provide access to all occupants in the room.
- If budget permits, utilize masonry or impact-resistant gypsum panels for partitions between corridors and classrooms. Intermediate partitions between adjacent classrooms is acceptable to be of conventional gypsum panels and studs.

## D. SECURITY CAMERAS

### i. OPERATION

- Monitor hallways, stairways, and other interior areas where undesirable activity may occur
- Monitor exterior parking lots, pedestrian walkways, entrances and exits, and athletic fields and related support spaces
- If cameras detect movement during unauthorized hours, employ a method for security staff to be alerted via text, email, or other means
- If cameras or a security system are employed, provide a 4-hour minimum battery backup for all relevant systems and connected devices
- Cameras systems can be integrated with a security alarm system so that a door alarm can trigger a Pan-Tilt-Zoom (PTZ) camera to preposition, aim at, and zoom in on the person entering the door



- ii. **RESOLUTION** - This is picture clarity, which must be sufficient on playback to distinguish the scene's key features. Video surveillance system manufacturers specify the amount of illumination needed for minimum function and for maximum performance. Image quality is also affected by excessive shadows (light to dark ratio), lens glare, and backlighting.
- iii. **COMMAND CENTER** - A command center is a central location from which staff can view, record, retrieve, or respond to video from one or more surveillance cameras. It may be a closet that serves a single camera for after the fact investigations or an actively monitored room that is collecting images from hundreds of cameras integrates video surveillance with other systems, such as access control and intrusion detection, or anywhere in between. Regardless of the Command Center setup – video files should be accessible by authorized personnel when needed.
- iv. **SYSTEMS INTEGRATION** - When selecting video surveillance system equipment, it is important to use a systems approach as opposed to a components approach. A systems approach examines how equipment will work with other elements of the video surveillance system, with other workplace systems, and with the environment in which it is needed. This approach results in a video surveillance system that operates effectively and satisfies a facility' s needs. By contrast, buying components separately and without an integration plan often results in a system that does not perform as expected, or to its fullest capacity.

## **E. OTHER CONSIDERATIONS**

### **i. PROCESS AND PROCEDURES**

- Assembly spaces or other high occupancy areas should be equipped with push to egress hardware that allows for immediate lockdown either electronically, manually, or both in case this area is designated as a shelter-in-place location. Minimize glazing into these spaces if this will be used as a hardened area for refuge.
- Ensure that all electrical panels are locked or are located within lockable rooms.
- Do not locate HVAC intakes or exhaust at a height or location that is easily accessible to pedestrians or at ground-level (Fig. 3E-1)
- Do not design 'climbing facilitators' that will allow unauthorized access to building roof or floors above ground level (Figs. 3E-2 and 3E-3)
- Consider shut-off buttons at all entrances/exits to electrical or mechanical rooms for air handlers, exhaust, boilers, and other infrastructure.
- Consider having intake and exhaust dampers installed that will shut through an interlock with the shut-down of the HVAC system. This is to prevent intrusion of toxic or otherwise unwanted exterior airborne pollutants
- Consider MERV 10 or higher filters for all air filtration systems and ensure that the system is designed for this static pressure
- Locate emergency generators no less than 25 feet from any parking or occupied structure.
- Provide local annunciation if alarm systems are activated
- Discuss owner requirements that are related to duress alarm systems
- Utilize recessed-mounted Knox Box or similar key retention system for master building key storage at each primary entrance per building. Consider adjacent recessed-mounted secure key storage box with exterior-rated keypad. This procedure would be employed as follows:
  - a. Alarm is sounded and first responders begin to dispatch to facility
  - b. First responders receive digital code from dispatch to open key distribution device
  - c. Code is entered at building entrance and key is provided that opens the Knox Box
  - d. Once this key is used to open the Knox Box then building master key is obtained and first responders can access building without the need for campus personnel to be on-scene
- Locate key storage box in a highly visible location with adequate lighting and camera coverage

- Design fire alarm system for not only alarm but also voice messaging for all personnel public address system.
- Ensure that alarm and public address messages are also sounded through exterior horns at all athletic fields, parking lots, or outbuildings to ensure that no campus occupants are missed in case of emergency notification.
- If technology permits, provide a geo-fenced notification boundary for emergencies. This will allow for emergency text messaging to be delivered to anyone located on the site at the time of an emergency regardless of whether they are an enrolled student, visitor, or other miscellaneous individuals who are present.

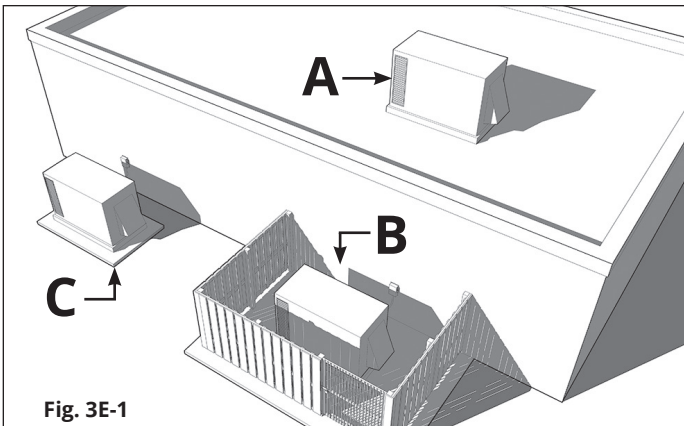
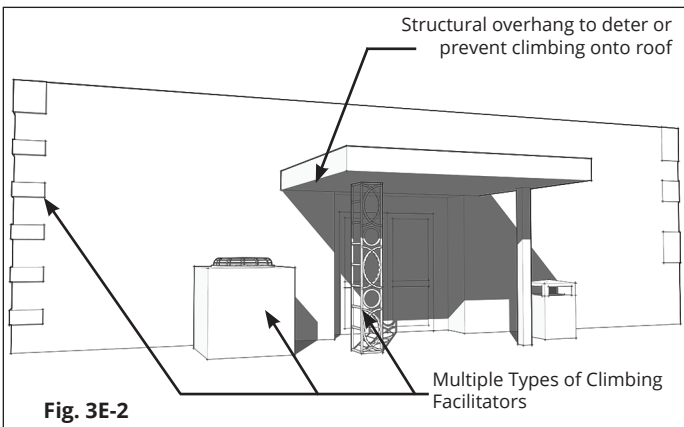

Fig 3E-1 shows three possible locations for typical HVAC equipment with an outdoor air intake. Location **A** is the most secure as it is located on the roof and if good design is practiced, it will be very difficult for unauthorized personnel to access the roof. Location **B** is better since the equipment is installed behind a security fence but it is still accessible and could allow for a ground-based release of toxic vapor to enter the building air intake. Location **C** is the worst as the equipment is unprotected at pedestrian level and could easily have toxins introduced into the airstream or at a minimum have the electrical service to the equipment shut off without authorization.



This building entrance has the following issues: (Fig. 3E-2).

1. The brick corbeling on the corner of the building can act as a climbing facilitator to anyone with slightly more skill than necessary to climb a ladder. Spacing and amount of ledge projection should be carefully planned to discourage climbing on corners such as this.
2. Placing an HVAC condensing unit (or anything else that can act as a stepping platform) can allow easy access onto upper portions of a building intended to be off-limits
3. The decorative column supporting the canopy can easily serve as a ladder to the roof or elevated portions of the building. If elements such as this are to be used, ensure there is a minimum of 24" from the top of the column to the lower edge of the roof. Here, more is better if structure and design allow it.

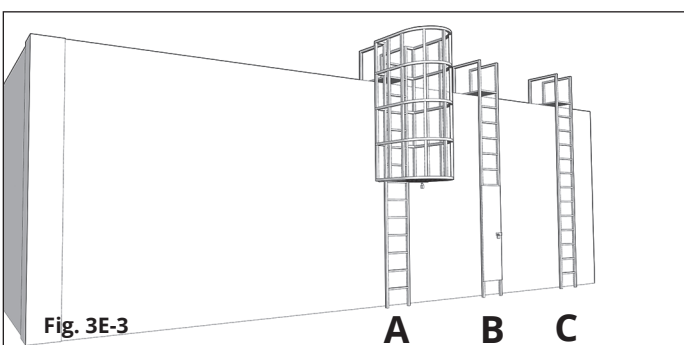

Figure 3E-3 shows three roof access ladders from best to worst. Ladder **A** has a fully enclosed cage with a locked entry cage preventing access. Ladder **B** has a solid metal plate covering access to the lower rungs. The top of this plate should be a minimum of 8' above grade and the hasp and lock should be recessed in order to not provide a place for a foothold. Ladder **C** provides no deterrence and allows unrestricted access to the roof.

## ii. ACCESS TO HELP

- Emergency telephones, intercoms, security alarms should be installed and easily visible to allow users to summon help during an emergency.

## **SECTION 4. FACILITY DESIGN CONSIDERATIONS FOR EMERGENCY PREPAREDNESS**

### **A. LOCATION-SPECIFIC THREAT EVALUATION**

- i. Coordinate with local emergency management personnel
  - Each county emergency manager will have a copy of their specific Basic Emergency Operations Plan (B.E.O.P)
  - The BEOP will list all local threats for design consideration
- ii. Identify site-specific and region-specific threats for design
  - Flood Threat
  - Tornado Threat
- iii. Facility shelter-in-place capacity
  - What is the maximum occupant count of the facility?
  - What are the various threats that may require shelter-in-place capacity?
  - Is it necessary for this facility to be able to offer shelter-in-place for all occupants?
  - If shelter-in-place capacity is required, how long must it be provided by each type of threat?
  - If necessary to shelter all occupants, ensure that adequate space is designed for this purpose while complying with all security points identified in this document.

### **B. FACILITY RESILIENCE AND REDUNDANCY**

- i. Does the facility need backup power?
- ii. If necessary, what power source is preferred?
- iii. Coordinate with owner, designer, and contractor team to identify the following:
  - What elements in the building need backup power?
  - Ensure that all team members understand what needs backup power and how these should be circuited
  - What is the total capacity necessary for all elements connected to backup power and should extra capacity for future-proofing be included?
  - Is the backup power source located in a secure location away from threats (flooding, winds, criminal tampering)?
  - Is the fuel source for the backup power in a secure location from threats (flooding, winds, criminal tampering)?
- iv. Are there any facility requirements that require double-redundancy?
  - Life sustaining power
  - Data Center Operations
  - Emergency Communications

### **C. RESILIENCY PROCEDURAL CONSIDERATIONS**

- i. Ensure that operations staff establish an approved test and preventive maintenance schedule for all emergency systems.
- ii. Ensure that sufficient staff are trained on emergency equipment operation to allow for primary personnel to be absent and still ensure continuity of operations.

## SECTION 5. SECURITY CONSIDERATIONS FOR BLAST-RESISTANT BUILDINGS AND NON-INVASIVE PHYSICAL SECURITY

### A. THE PRIMARY GOALS OF BLAST-RESISTIVE DESIGN ARE AS FOLLOWS:

- i. Prevent or delay progressive collapse (the building or structure collapses from cascading failures after the initial blast damage, such as damage to a primary structural column, shear wall, etc...) Studies have shown that when an attack is directed against a building, the majority of fatalities are a result of building collapse.
- ii. Facilitate rescue/recovery by limiting debris blocking access to the building (the building needs to maintain ingress and egress long enough for all the occupants and critical contents to be safely evacuated safely at a minimum).
- iii. Protect occupants from flying debris

### B. PRIMARY TYPES OF BLAST THREATS TO BUILDINGS AND OCCUPANT SAFETY:

- i. Vehicle Threats:
  1. VBIED (Vehicle Borne Improvised Explosive Device)
  2. Ramming attacks from high speed vehicle – could be coupled with an explosive device after ramming
- ii. Personnel Threats:
  1. Hand-carried explosive devices
  2. Firearms and other handheld weapons
- iii. Infrastructure Failure Threats:
  1. Loss of communications
  2. Loss of grid-tie electrical power
  3. Loss of municipal water supply
- iv. Types of threat from explosion:
  1. Immediate blast effects
    - a. Air-blast
    - b. Progressive Collapse
  2. Thermal effects
  3. Shrapnel
  4. Debris and building components becoming projectiles (i.e.-glass fragments)

**FBI/DHS RECOMMENDED STAND-OFF DISTANCES - TABLE 5B**

THREAT	EXPLOSIVES CAPACITY	MANDATORY EVACUATION DISTANCE	SHELTER-IN-PLACE ZONE	PREFERRED EVACUATION DISTANCE
PIPE BOMB	5 LBS	70 FT	71-1,119 FT	+1,200 FT
SUICIDE BOMB	20 LBS	110 FT	111-1,699 FT	+1,700 FT
BRIEFCASE	50 LBS	150 FT	151-1,849 FT	+1,850 FT
CAR	500 LBS	320 FT	321-1,899 FT	+1,900 FT
SUV/VAN	1000 LBS	400 FT	401-2,399 FT	+2,400 FT
SMALL DELIVERY TRUCK	4,000 LBS	640 FT	641-3,799 FT	+3,800 FT
CONTAINER/WATER TRUCK	10,000 LBS	860 FT	861-5,099 FT	+5,100 FT
SEMI-TRAILER	60,000 LBS	1,570 FT	1,571-9,299 FT	+9,300 FT

This table displays the recommended stand-off distances for occupant safety in the event of an explosive detonation. These distances may be considered when locating parking lots adjacent to structures or commonly used pathways for pedestrian travel.

As explosives travel in a spherical shape, these distances are the radii to be considered when designing a multi-building campus or site plan.

**Fig. 5B-1**



Figure 5B-1 depicts the hemispherical blast wave created by the truck detonation at ground level. The progressively fading circles of color on the front of the building illustrate how the blast wave expands outward from the center of the burst but loses power the further from the center the wave progresses. The arrows on the sides of the building illustrate the various forces that act on the building envelope in nonstandard ways as the blast wave passes around, over, and behind the structure.

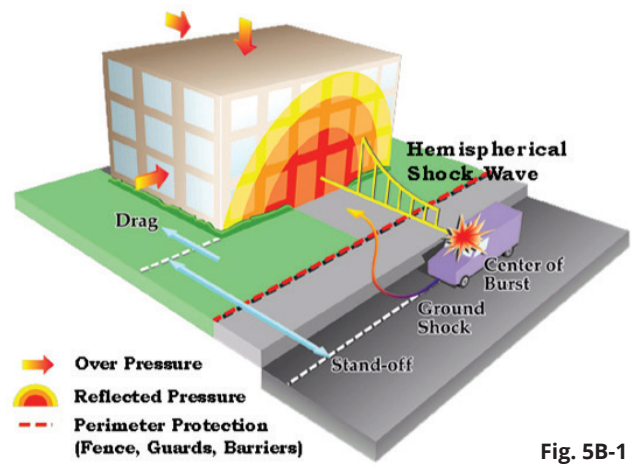

Fig. 5B-1

Figure 5B-2 depicts how progressive collapse begins and ultimately brings the building down onto itself. Ground floor walls and columns are damaged, upper floors are lifted by the blast wave, and then the downward pressure from the blast wave creates an overwhelming load that the remaining structure cannot support.

*FEMA 427, Primer for Design of Commercial Buildings to Mitigate Terrorist Attacks*, details the basics of shock wave principles as well as the criticality of setback from property lines and potential avenues of approach to the building. Many security and blast mitigation recommendations are based on the assumption that adequate setback (based on perceived or evaluated threat) has already been provided to the greatest extent possible considering the restrictions of the site. This should include not only the façade of the building facing any surface streets but property lines in all directions.

FEMA 427 identifies Levels of Damage as:

- i. **Minor:** Nonstructural failure of building elements such as windows, doors, cladding, and false ceilings. Injuries may be expected, and fatalities are possible but unlikely.
- ii. **Moderate:** Structural damage is confined to a localized area and is usually repairable. Structural failure is limited to secondary structural members such as beams, slabs, and non-load-bearing walls. However, if the building has been designed for loss of primary members, localized loss of columns may be accommodated. Injuries and possible fatalities are expected.
- iii. **Major:** Loss of primary structural components such as columns or transfer girders precipitates loss of additional adjacent members that are adjacent to or above the lost member. In this case, extensive fatalities are expected. Building is usually not repairable.

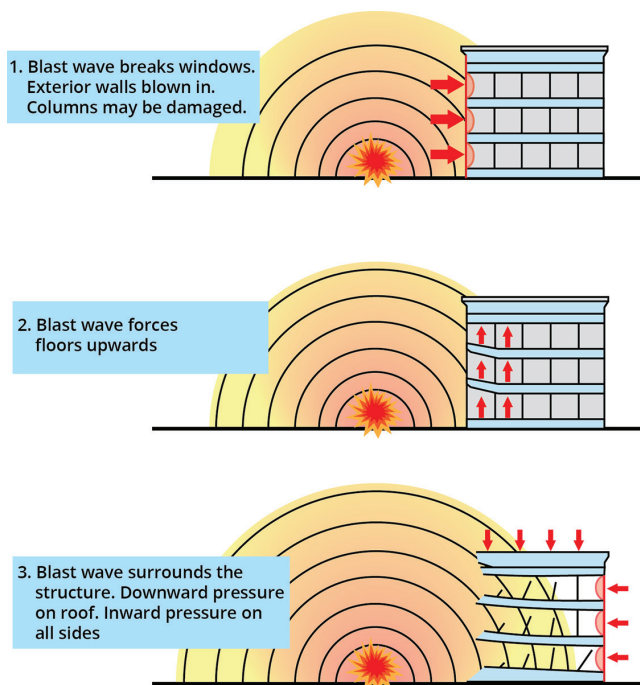

Fig. 5B-2

### C. Site and Architectural issues:

- i. Site location and standoff from publicly accessible spaces (TABLE 5B)
- ii. Blast wave effects on building components (Figs. 5B1 - 5B-2)
- iii. Building Shape: (Fig 5B-3)

The shape of the building can have a contributing effect on the overall damage to the structure (see Figure Fig 5B-3). Re-entrant corners and overhangs are likely to trap the shock wave and amplify the effect of the air blast. Note that large or gradual re-entrant corners have less effect than small or sharp re-entrant corners and overhangs. The reflected pressure on the surface of a circular building is less intense than on a flat building. When curved surfaces are used, convex shapes are preferred over concave shapes. Terraces that are treated as roof systems subject to downward loads require careful framing and detailing to limit internal damage to supporting beams.

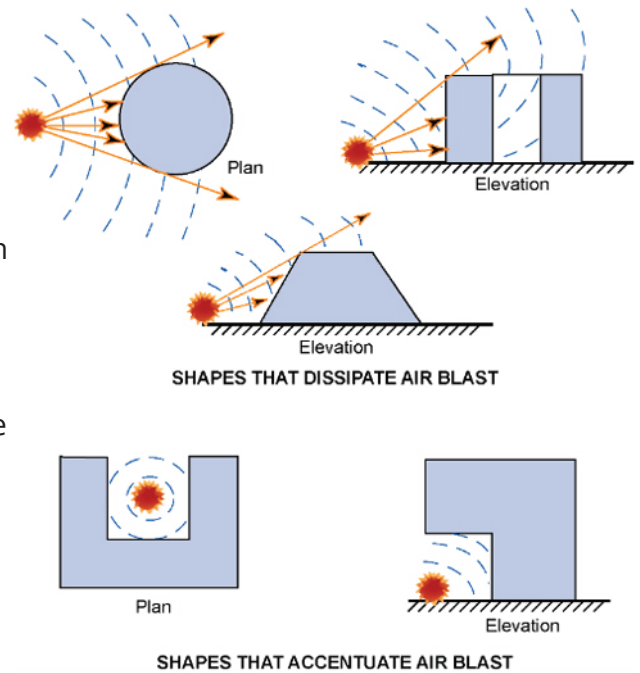

Fig. 5B-3

Generally, simple geometries and minimal ornamentation (which may become flying debris during an explosion) are recommended unless advanced structural analysis techniques are used. If ornamentation is used, it is preferable to use lightweight materials such as timber or plastic, which are less likely than brick, stone, or metal to become lethal projectiles in the event of an explosion.



