

Structures Calculation Guide



Roadway Design Division

Website: www.tn.gov/tdot/roadway-design/training.html

Email: TDOT.RoadwayDesignDivisionTraining@tn.gov

Table of Contents

Part 1 – Bridge Ends.....	3
STD-10-2.....	3
STD-10-3.....	5
Part 2 – Box Bridge Quantities Calculation (Fill).....	8
Part 3 – Box Bridge Quantities Calculation (No Fill)	13
Part 4 – Bridge Earthwork	18
Part 5 – Backfill for Box Bridges and Culverts	24
Part 6 – Bridge Apron Calculation	30

Part 1 – Bridge Ends

Additional roadway quantities are needed for bridge end transitions. Structure Standard Drawings STD-10-2 and STD-10-3 have roadway quantities that are excluded from the structures quantities that need to be calculated separately. Below are those quantities in both standard drawings.

STD-10-2

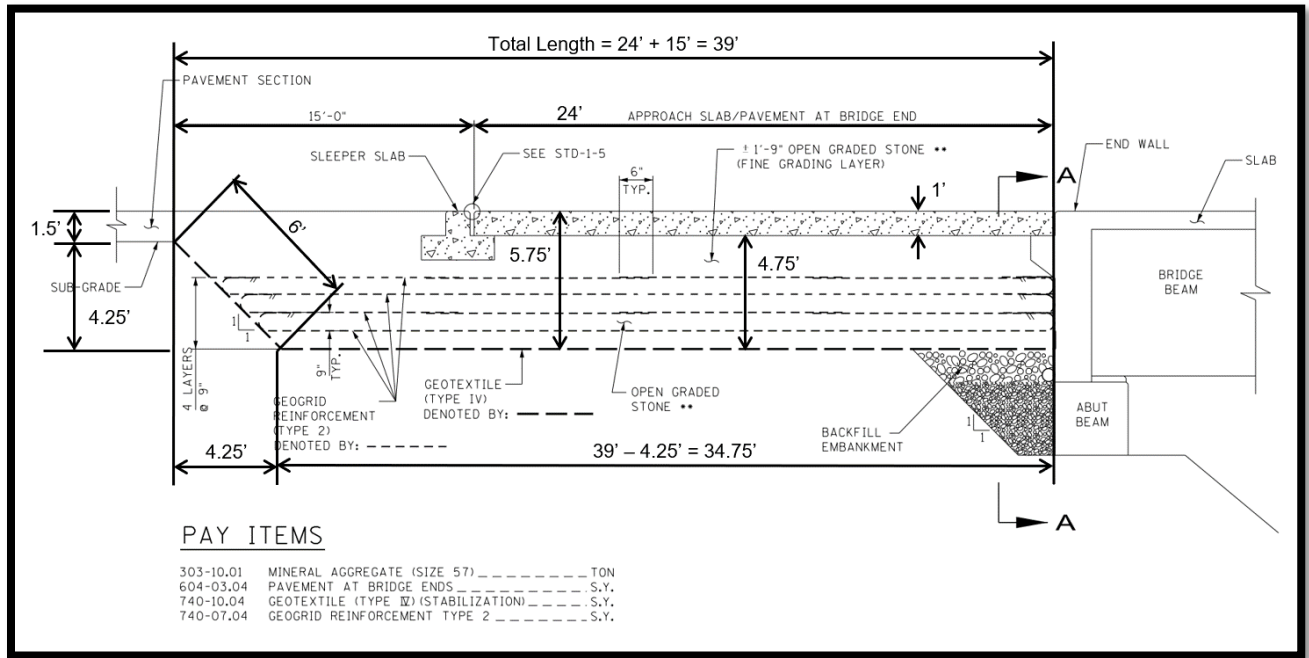

Assumed Dimensions (These dimensions will vary based on each project):

- Roadway Width = 32' (Two 12' lanes with 4' shoulders)
- Pavement thickness = 1.5'

Standard Dimensions:

- Approach Slab = 24' (From STD-1-5)
- Thickness (From STD-10-2) (NOT including the backfill embankment)
 - 4 layers at 0.75' each = 3'
 - Fine Graded Stone = 1.75'
 - Slab Thickness (From STD-1-5) = 1'
 - Total Thickness = 5.75'

Calculated Dimensions:

- Triangle Area:
 - Total Thickness – Pavement Thickness = Triangle Height
 - $5.75' - 1.5' = 4.25'$
- Since the triangle is 1:1, the width = height = 4.25'
 - Length = $\sqrt{4.25^2 + 4.25^2} = 6'$

303-10.01 Mineral Aggregate (Size 57):

24' section: $32' \times 24' \times 4.75' = 3648 \text{ CF} = 135.1 \text{ CY}$

15' section: $32' \times 15' \times 5.75' = 2760 \text{ CF} = 102.2 \text{ CY}$

Subtract the 1:1 sloped triangle area:

- $32' \times \frac{4.25' \times 4.25'}{2} = 289 \text{ CF} = 10.7 \text{ CY}$

Subtract for Sleeper Slab (cross section area = 4 SF) (From Standard Drawing STD-1-5)

- $32 \text{ FT} \times 4 \text{ SF} = 128 \text{ CF} = 4.7 \text{ CY}$

Total = 221.9 CY

x 2 ends = 443.8 CY

x 1.34 TONS/CY = **595 TONS** (Based on 32' width)

604-03.04 Pavement at Bridge Ends:

Pavement Width x Approach Slab (Pavement at Bridge End)

$32' \times 24' = 768 \text{ SF} = 85.3 \text{ SY}$

x 2 = **171 SY** (Based on 32' width)

740-07.04 Geogrid Reinforcement Type 2:

Pavement Width x (Sum of Geogrid Reinforcement Layers)

$32' \times (35.5' + 36.25' + 37.00' + 37.75') = 4688 \text{ SF} = 520.9 \text{ SY}$

x2 = **1042 SY** (Based on 32' width)

740-10.04 Geotextile (Type IV) (Stabilization):

Pavement Width x (Sum of Geotextile (Type IV))

$32' \times (6' + 34.75') = 1304 \text{ SF} = 144.9 \text{ SY}$

x2 = **290 SY** (Based on 32' width)

These quantities will vary depending on the actual dimensions of the roadway.

On Estimated Quantities sheet include this footnote for the quantities calculated for these item numbers:

INCLUDES X FOR BRIDGE ENDS.

STD-10-3

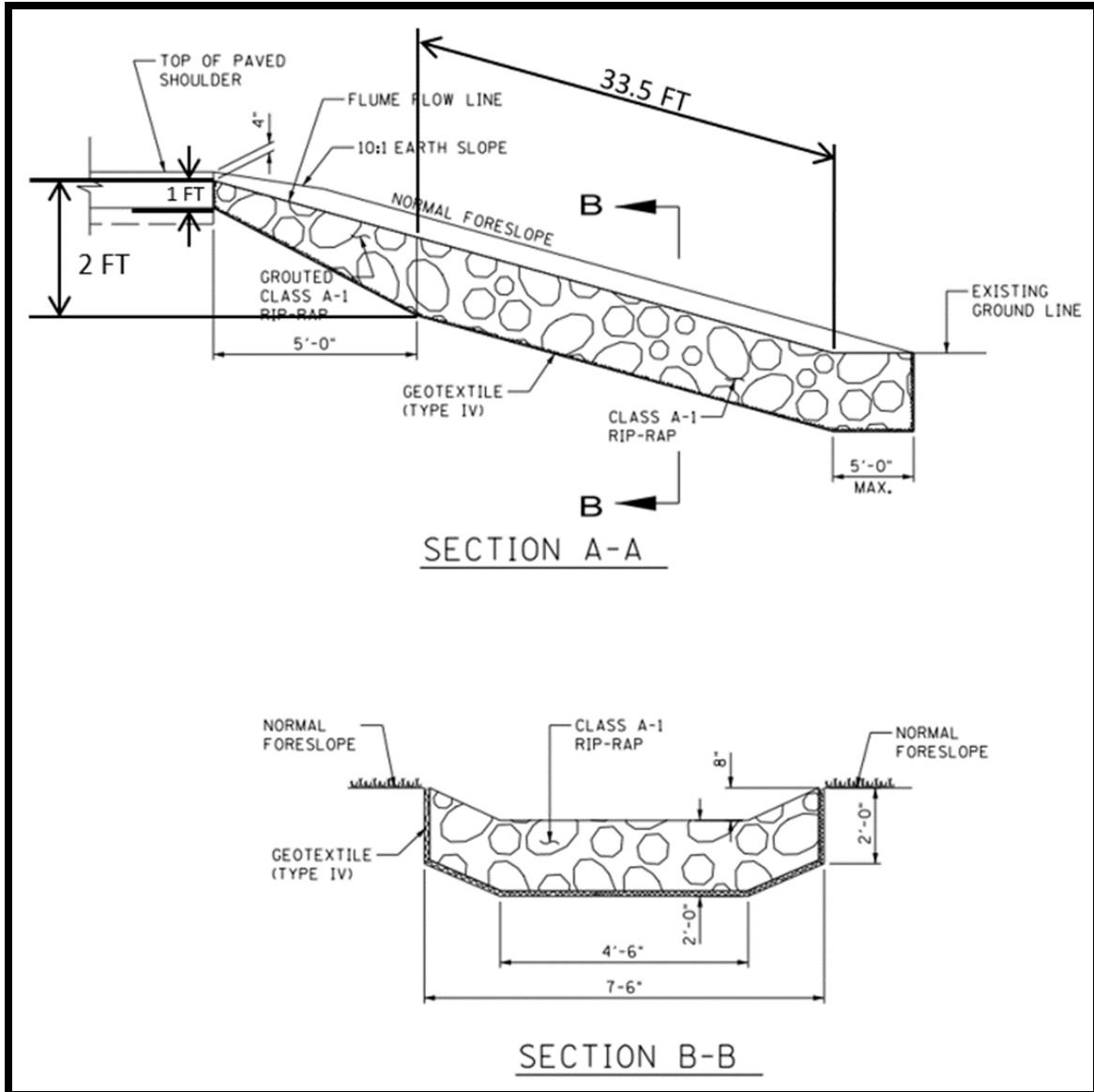

For a slope of 2:1 and height of 15 feet, the length along the slope is 33.5 feet. See below for more details.

Height = 15 ft

Length = 15 ft x 2 = 30 ft (For 2:1 slope)

Length along slope = $\sqrt{(15^2 + 30^2)} = 33.5$ ft

709-05.06 Machined Rip-Rap (Class A-1):

First 5 FT Grouted section: (See the last Special Note on STD-10-3 for more detail)

Length x (Average Area)

$$5' \times \frac{[(4.5' \times 1') + (3' \times 1')] + [(4.5' \times 2') + (3' \times 2')]}{2} = 56.25 \text{ CF} = 2.1 \text{ CY}$$

33.5 FT section:

(Middle volume) + (Tapered volume)

$$+ (4.5' \times 2' \times 33.5') + (3' \times 2' \times 33.5') = 502.5 \text{ CF} = 18.6 \text{ CY}$$

Last 5 FT Max section:

(Middle volume) + (Tapered volume)

$$+ (4.5' \times 2' \times 5') + (3' \times 2' \times 5') = 75 \text{ CF} = 2.8 \text{ CY}$$

Total = 23.5 CY

x 1.75 TONS/CY = **42 TONS**

740-10.04 Geotextile (Type IV) (Stabilization):

Width:

Middle Width + 2 Sides x (Diagonal length + Height)

$$4.5' + 2 \times (2' + 2') = 12.5 \text{ FT}$$

Length:

First 5' Grouted Section + Main section + 5' max section

$$5' + 33.5' + 5' = 43.5 \text{ FT}$$

Total Area:

Total Width x Total Length

$$12.5' \times 43.5' = 543.8 \text{ SF} = \mathbf{61 \text{ SY}}$$

These quantities will vary depending on the actual dimensions of the roadway.

On Estimated Quantities sheet include this footnote:

INCLUDES X FOR BRIDGE ENDS

Part 2 – Box Bridge Quantities Calculation (Fill)

Given:

Structure 144 LF of 6' x 3' (cell width x cell height) Reinforced Concrete Box Culvert Skew 70°

Maximum Fill Height = 24'

Measure at the center of box culvert from top of slab to final grade

Slope = 2:1

Per Typical Sections in plans

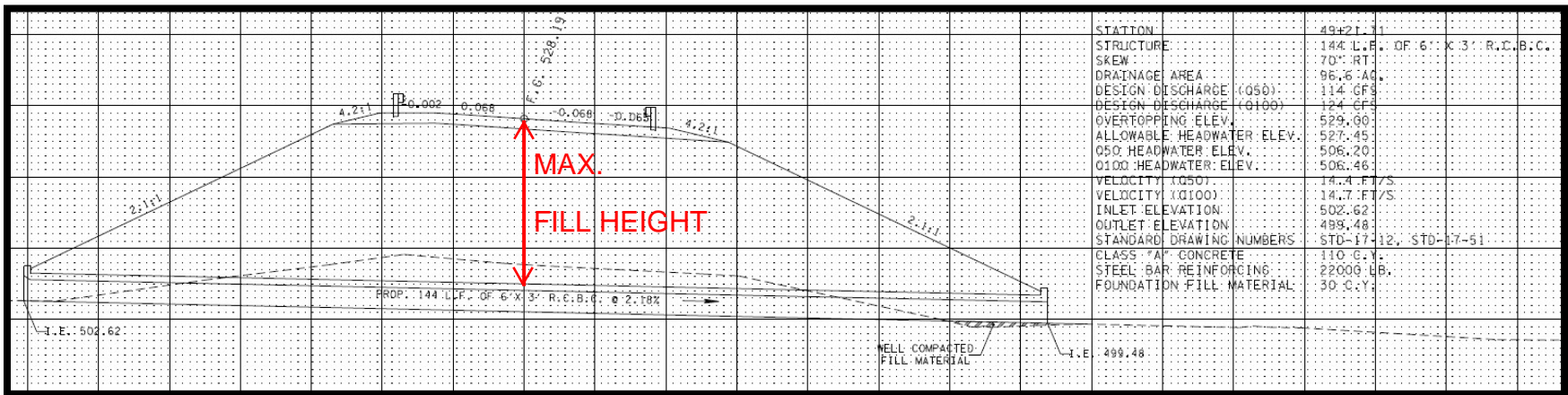

Solution:

Calculate box bridge quantities.

Refer to Standard Drawing STD-17-51

1 @ 6 x 3 REINFORCED CONCRETE BOX BRIDGE																																	
Maximum Fill Height ft.	Dimensions				Bars TST				Bars TSB				Bars BST				Bars BSB				Bars EWE				Bars EWI			Bars LNT	Bars L'ND	Bars WS	Concrete CY/LF	Reinf. Steel LB/LF	
	ST in.	SB in.	WT in.	BW ft.	Size	No.	Spacing in.	Length ft.	Size	No.	Spacing in.	Length ft.	Size	No.	Spacing in.	Length ft.	Size	No.	Spacing in.	Length ft.	Size	No.	Spacing in.	Length ft.	Size	No.	Spacing in.	Length ft.	No.	No.	No.		
No Fill	8.5	9	8	7.33	4	1	12	6.83	6	2	6	6.83	5	2	12	7.83	4	1	12	7.83	4	2	12	3.00	5	2	12	3.00	35	12	4	0.57	142
3	10	10	8	7.33	4	1	12	6.83	6	2	6	6.83	7	1	12	7.83	4	1	12	7.83	4	2	12	3.00	5	2	12	3.00	35	12	4	0.63	141
5	8	9	8	7.33	4	1	12	6.83	5	2	6	6.83	5	2	12	7.83	4	1	12	7.83	4	2	12	3.00	5	2	12	3.00	42	0	4	0.56	132
10	8	9	8	7.33	4	1	12	6.83	5	2	6	6.83	7	1	12	7.83	4	1	12	7.83	4	2	12	3.00	5	2	12	3.00	42	0	4	0.56	132
20	8	9	8	7.33	4	1	12	6.83	6	2	6	6.83	6	2	6	7.83	4	1	12	7.83	4	2	12	3.00	5	2	12	3.00	42	0	4	0.56	146
30	11	13	8	7.33	4	1	12	6.83	6	2	6	6.83	8	1	12	7.83	4	1	12	7.83	4	2	12	3.00	5	2	12	3.00	42	0	4	0.73	143
40	14	15	8	7.33	4	1	12	6.83	6	2	6	6.83	8	1	12	7.83	4	1	12	7.83	4	2	12	3.00	5	2	12	3.00	42	0	4	0.85	143
50	16	17	8	7.33	4	1	12	6.83	6	2	6	6.83	8	1	12	7.83	4	1	12	7.83	4	2	12	3.00	5	2	12	3.00	42	0	4	0.95	143
60	17	18	8	7.33	4	1	12	6.83	7	2	6	6.83	6	2	6	7.83	4	1	12	7.83	4	2	12	3.00	5	2	12	3.00	42	0	4	1.00	153

Use table for 1 @ 6 x 3 Box Bridge

Since Maximum Fill Height (FT) = 24 FT, which is between 20 FT and 30 FT in the table, use values for the larger fill height of 30 FT

Therefore,

Concrete = 0.73 CY/LF

Reinforcing Steel = 143 LB/LF

The box bridge is 144 FT long

Concrete = 0.73 CY/LF x 144 FT = 105.12 CY

Reinforcing Steel = 143 LB/LF x 144 FT = 20592 LB

Calculate the wing wall quantities.

Since the skew = 70°, round to the nearest skew value (90°, 75°, 60°, 45°). Use values for skew = 75°.

Refer to Standard Drawing STD-17-12, the quantities given in the tables in Standard Drawing STD-17-12 are for **ALL FOUR WINGWALLS**

75° SKEW

2:1 SLOPE						
H	WL	hl	WS	hs	CONCRETE (C.Y.)	REINF. STEEL (LBS.)
4	6.00	2.25	4.50	1.75	2.6	641
4.5	6.75	2.50	5.25	2.00	3.7	710
5	7.50	2.75	5.75	2.25	5.5	790
5.5	8.50	3.00	6.50	2.50	6.7	935
6	9.25	3.25	7.25	2.50	7.7	1,019
6.5	10.00	3.75	7.75	2.75	8.9	1,096
7	11.00	4.00	8.50	3.00	10.8	1,408
7.5	11.75	4.25	9.00	3.25	12.1	1,515
8	12.50	4.50	9.75	3.50	13.6	1,626
8.5	13.50	4.75	10.25	3.75	15.3	1,773
9	14.25	5.00	11.00	4.00	18.1	2,646
9.5	15.00	5.50	11.50	4.25	20.0	2,725
10	16.00	5.75	12.25	4.50	22.2	3,018
10.5	16.75	6.00	12.75	4.75	24.2	3,146
11	17.50	6.25	13.50	4.75	28.1	3,503
11.5	18.50	6.50	14.25	5.00	31.3	4,373
12	19.25	6.75	14.75	5.25	33.6	4,638
12.5	20.00	7.25	15.50	5.50	37.0	4,832
13	20.75	7.50	16.00	5.75	42.0	5,744
13.5	21.25	7.75	16.75	6.00	44.8	6,169
14	22.50	8.00	17.25	6.25	48.4	6,454
14.5	23.25	8.25	18.00	6.50	51.5	6,822
15	24.25	8.75	18.50	6.75	58.5	7,370
15.5	25.00	9.00	19.25	7.00	63.9	8,362
16	25.75	9.25	19.75	7.00	67.3	8,778
16.5	26.75	9.50	20.50	7.25	71.8	10,207
17	27.50	9.75	21.00	7.50	78.2	11,200
17.5	28.25	10.00	21.75	7.75	82.6	11,188
18	29.25	10.50	22.50	8.00	88.0	11,667
18.5	30.00	10.75	23.00	8.25	92.4	11,878
19	30.75	11.00	23.75	8.50	104.9	13,387
19.5	31.75	11.25	24.25	8.75	110.2	15,072
20	32.50	11.50	25.00	9.00	116.7	15,803
20.5	33.25	11.75	25.50	9.00	121.6	16,206
21	34.00	12.25	26.25	9.25	136.2	17,837

3:1 SLOPE						
H	WL	hl	WS	hs	CONCRETE (C.Y.)	REINF. STEEL (LBS.)
4	7.25	2.50	5.75	2.25	4.5	691
4.5	8.25	3.00	6.75	2.50	5.7	761
5	9.00	3.25	7.50	2.75	7.2	861
5.5	10.00	3.75	8.25	3.00	8.5	1,017
6	11.00	4.00	9.00	3.25	9.9	1,122
6.5	12.00	4.25	9.75	3.50	11.4	1,207
7	13.00	4.75	10.50	3.75	13.6	1,537
7.5	14.00	5.00	11.25	4.00	15.7	1,672
8	15.00	5.25	12.00	4.25	17.7	1,801
8.5	15.75	5.75	12.75	4.75	19.7	1,987
9	16.75	6.00	13.75	5.00	23.3	3,019
9.5	17.75	6.25	14.50	5.25	25.7	3,112
10	18.75	6.75	15.25	5.50	28.3	3,426
10.5	19.75	7.00	16.00	5.75	31.4	3,627
11	20.75	7.50	16.75	6.00	35.5	4,061
11.5	21.50	7.75	17.50	6.25	39.5	4,904
12	22.50	8.00	18.25	6.50	42.7	5,207
12.5	23.50	8.50	19.00	6.75	46.3	5,388
13	24.50	8.75	19.75	7.00	53.2	6,454
13.5	25.50	9.00	20.75	7.50	55.3	6,892
14	26.50	9.50	21.50	7.75	64.5	7,348
14.5	27.50	9.75	22.25	8.00	68.8	7,780
15	28.25	10.00	23.00	8.25	74.7	8,379
15.5	29.25	10.50	23.75	8.50	79.6	9,359
16	30.25	10.75	24.50	8.75	84.4	9,839
16.5	31.25	11.00	25.25	9.00	92.9	11,836
17	32.25	11.50	26.00	9.25	101.8	12,984
17.5	33.25	11.75	26.75	9.50	107.4	12,925
18	34.00	12.25	27.75	9.75	111.4	13,414
18.5	35.00	12.50	28.50	10.25	119.7	13,702
19	36.00	12.75	29.25	10.50	131.7	15,117
19.5	37.00	13.25	30.00	10.75	142.2	17,331
20	38.00	13.50	30.75	11.00	151.8	18,121
20.5	39.00	13.75	31.50	11.25	158.9	18,687
21	39.75	14.25	32.25	11.50	176.7	20,378

Refer to Standard Drawings STD-17-51 and STD-17-8, use **H = 5 FT**

$$H = \text{CELL HEIGHT} + \text{+ST} + \text{CURB} = 3 \text{ FT} + 11 \text{ IN (1 FT/ 12 IN)} + 1 \text{ FT} = 4.92 \text{ FT, USE 5 FT}$$

If box bridge has a guardrail, use STD-17-7 instead of STD-17-8.

1 @ 6 x 3 REINFORCED CONCRETE BOX BRIDGE																																	
Maximum Fill Height ft.	Dimensions				Bars TST				Bars TSB				Bars BST				Bars BSB				Bars EWE				Bars EWI				Bars LNT	Bars LND	Bars WS	Concrete CY/LF	Reinf. Steel LB/LF
	ST in.	SB in.	WT in.	BW ft.	Size	No.	Spacing in.	Length ft.	Size	No.	Spacing in.	Length ft.	Size	No.	Spacing in.	Length ft.	Size	No.	Spacing in.	Length ft.	Size	No.	Spacing in.	Length ft.	No.	No.	No.						
No Fill	8.5	9	8	7.33	4	1	12	6.83	6	2	6	6.83	5	2	12	7.83	4	1	12	7.83	4	2	12	3.00	5	2	12	3.00	35	12	4	0.57	142
3	10	10	8	7.33	4	1	12	6.83	6	2	6	6.83	7	1	12	7.83	4	1	12	7.83	4	2	12	3.00	5	2	12	3.00	35	12	4	0.63	141
5	8	9	8	7.33	4	1	12	6.83	5	2	6	6.83	5	2	12	7.83	4	1	12	7.83	4	2	12	3.00	5	2	12	3.00	42	0	4	0.56	132
10	8	9	8	7.33	4	1	12	6.83	5	2	6	6.83	7	1	12	7.83	4	1	12	7.83	4	2	12	3.00	5	2	12	3.00	42	0	4	0.56	132
20	8	9	8	7.33	4	1	12	6.83	6	2	6	6.83	6	2	6	7.83	4	1	12	7.83	4	2	12	3.00	5	2	12	3.00	42	0	4	0.56	146
30	11	13	8	7.33	4	1	12	6.83	6	2	6	6.83	8	1	12	7.83	4	1	12	7.83	4	2	12	3.00	5	2	12	3.00	42	0	4	0.73	143
40	14	15	8	7.33	4	1	12	6.83	6	2	6	6.83	8	1	12	7.83	4	1	12	7.83	4	2	12	3.00	5	2	12	3.00	42	0	4	0.85	143
50	16	17	8	7.33	4	1	12	6.83	6	2	6	6.83	8	1	12	7.83	4	1	12	7.83	4	2	12	3.00	5	2	12	3.00	42	0	4	0.95	143
60	17	18	8	7.33	4	1	12	6.83	7	2	6	6.83	6	2	6	7.83	4	1	12	7.83	4	2	12	3.00	5	2	12	3.00	42	0	4	1.00	153

Use Table from STD-17-51

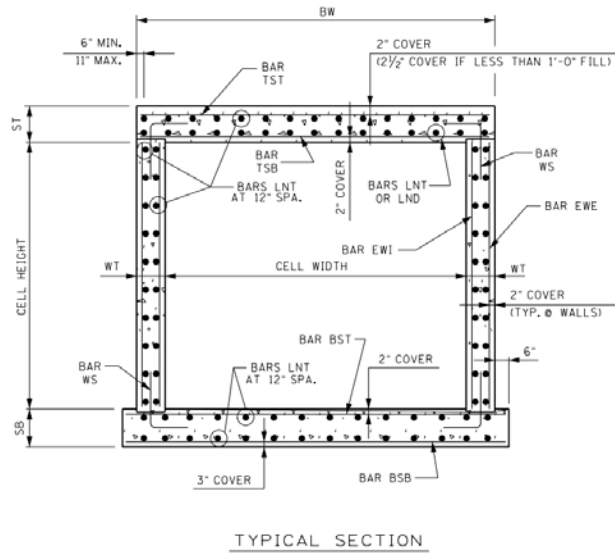

Use Typical Section from STD-17-51

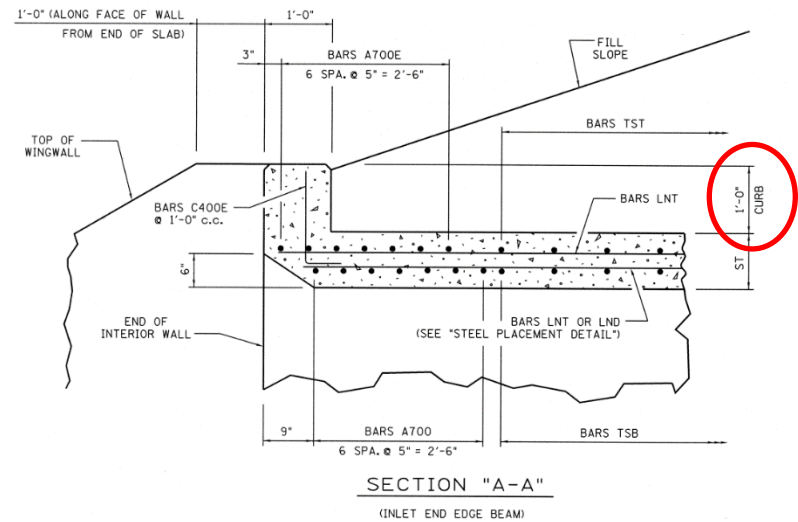

Use Section "A-A" from STD-17-8

Therefore,

Concrete = 5.5 CY

Reinforcing Steel = 790 LB

The quantities given in tables in Standard Drawings STD-17-12 are for ALL FOUR WINGWALLS.

Therefore,

TOTAL CONCRETE = 105.12 CY + 5.5 CY = 110.62 CY

TOTAL REINFORCING STEEL = 20592 LB + 790 LB = 21382 LB

NOTE: When necessary, calculate the edge beam and cut-off wall quantities and add total quantities above. See Standard Drawing STD-17-8 and STD-17-6 for more details.

Part 3 – Box Bridge Quantities Calculation (No Fill)

Given:

Structure 3 @ 18'x12'x26' (cell width x cell height x bridge length) Reinforced Concrete Box Bridge Skew 90°

Maximum Fill Height (FT) = No Fill

Since the top of the top slab will be a riding surface, Maximum Fill Height = 0

Slope = 2:1

Per Typical Sections in plans

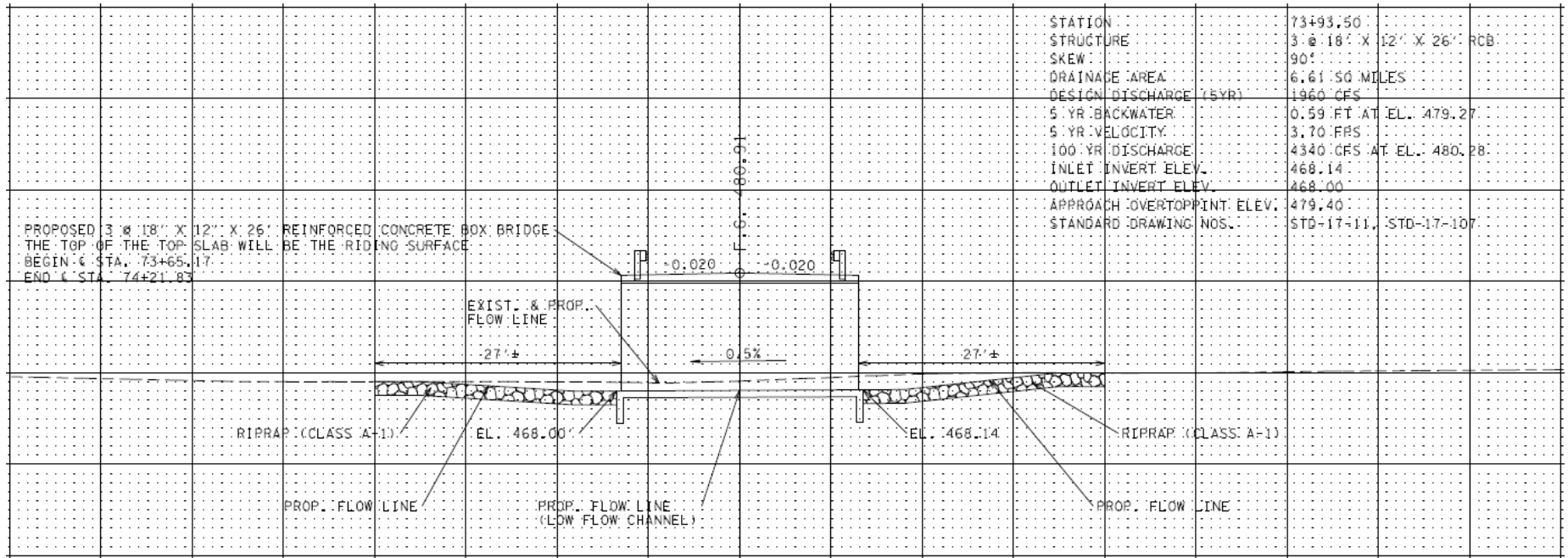

Solution:

Calculate box bridge quantities.

Refer to Standard Drawing STD-17-107

3 @ 18 x 12 REINFORCED CONCRETE BOX BRIDGE																																						
Maximum Fill Height ft.	Dimensions					Bars TST			Bars TSB			Bars BST			Bars BSB			Bars EWE			Bars EW			Bars IW			Bars LNT	Bars LND	Bars WS	Concrete CY/LF	Reinf. Steel LB/LF							
	ST in.	SB in.	WT in.	IT in.	BW ft.	Size	No.	Spacing in.	Length ft.	Size	No.	Spacing in.	Length ft.	Size	No.	Spacing in.	Length ft.	Size	No.	Spacing in.	Length ft.	Size	No.	Spacing in.	Length ft.	Size	No.	Spacing in.	Length ft.	No.	No.	No.						
No Fill	11.5	11	8	8	56.67	8	2	6	56.17	8	2	6	56.17	6	2	6	57.17	7	2	6	57.17	4	2	12	12.00	7	2	12	12.00	5	4	12	12.00	268	108	8	5.15	1477
3	15	15	8	8	56.67	11	1	12	56.17	8	2	6	56.17	6	2	6	57.17	7	2	6	57.17	4	2	12	12.00	7	4	6	12.00	5	4	12	12.00	266	108	8	6.46	1525
5	16	16	9	8	56.83	11	1	12	56.33	7	2	6	56.33	9	1	12	57.33	7	2	6	57.33	4	2	12	12.00	7	4	6	12.00	5	4	12	12.00	322	0	8	6.92	1445
10	20	20	10	8	57.00	11	1	12	56.50	7	2	6	56.50	9	1	12	57.50	8	2	6	57.50	4	2	12	12.00	7	4	6	12.00	5	4	12	12.00	326	0	8	8.43	1522
20	20	21	12	8	57.33	4	3	12	18.66	11	2	6	56.83	10	2	6	57.83	4	3	12	18.66	4	2	12	12.00	8	4	6	12.00	5	4	12	12.00	326	0	8	8.80	1695
30	29	30	15	8	57.83	4	3	12	18.66	10	2	6	57.33	10	2	6	58.33	4	3	12	18.66	4	2	12	12.00	7	4	6	12.00	6	4	12	12.00	326	0	8	12.33	1581
40	36	37	17	8	58.17	4	3	12	18.66	10	2	6	57.67	10	2	6	58.67	4	3	12	18.66	4	2	12	12.00	7	4	6	12.00	5	8	6	12.00	330	0	8	15.07	1617
50	41	42	19	9	58.67	4	3	12	18.66	10	2	6	58.17	10	2	6	59.17	4	3	12	18.66	4	2	12	12.00	7	4	6	12.00	5	8	6	12.00	330	0	8	17.23	1628
60	46	47	20	9	58.83	4	3	12	18.66	10	2	6	58.33	10	2	6	59.33	4	3	12	18.66	4	2	12	12.00	7	4	6	12.00	6	8	6	12.00	330	0	8	19.18	1673

Use table for 3 @ 18 x 12 Box Bridge

Use Maximum Fill Height (FT) = No Fill

Therefore,

Concrete = 5.15 CY/LF

Reinforcing Steel = 1477 LB/LF

The box bridge is 26 FT long

Concrete = 5.15 CY/LF * 26 FT = 133.9 CY

Reinforcing Steel = 1477 LB/LF * 26 FT = 38402 LB

Calculate the wing wall quantities.

Refer to Standard Drawing STD-17-11, the quantities given in the tables in Standard Drawing STD-17-11 are for **ALL FOUR WINGWALLS.**

90° SKEW

2:1 SLOPE					3:1 SLOPE				
H	W	h	CONCRETE (C.Y.)	REINF. STEEL (LBS.)	H	W	h	CONCRETE (C.Y.)	REINF. STEEL (LBS.)
4	5.00	1.75	3.3	630	4	6.25	2.25	4.3	675
4.5	5.75	2.00	4.1	694	4.5	7.25	2.50	5.4	744
5	6.50	2.25	5.3	781	5	8.00	3.00	6.9	849
5.5	7.25	2.50	6.3	914	5.5	9.00	3.25	8.3	1,014
6	8.00	2.75	7.4	1,014	6	9.75	3.50	9.5	1,116
6.5	8.50	3.00	8.4	1,069	6.5	10.50	3.75	10.8	1,180
7	9.25	3.25	10.1	1,367	7	11.50	4.00	13.1	1,520
7.5	10.00	3.50	11.5	1,486	7.5	12.25	4.50	14.9	1,624
8	10.75	3.75	13.0	1,607	8	13.25	4.75	16.9	1,754
8.5	11.50	4.00	14.6	1,749	8.5	14.00	5.00	19.5	1,974
9	12.25	4.25	16.9	2,576	9	14.75	5.25	22.2	2,962
9.5	12.75	4.50	18.4	2,639	9.5	15.75	5.50	24.7	3,082
10	13.50	4.75	20.4	2,875	10	16.50	6.00	27.3	3,342
10.5	14.25	5.00	23.2	3,091	10.5	17.50	6.25	30.1	3,504
11	15.00	5.25	26.3	3,494	11	18.25	6.50	33.6	3,928
11.5	15.75	5.50	30.3	4,328	11.5	19.00	6.75	37.5	4,786
12	16.50	5.75	32.9	4,544	12	20.00	7.00	41.9	5,216
12.5	17.00	6.00	35.1	4,662	12.5	20.75	7.50	45.4	5,394
13	17.75	6.25	39.4	5,610	13	21.75	7.75	52.0	6,412
13.5	18.50	6.50	42.4	6,003	13.5	22.50	8.00	55.4	6,870
14	19.25	6.75	45.5	6,260	14	23.25	8.25	59.0	7,136
14.5	20.00	7.00	49.9	6,741	14.5	24.25	8.50	63.3	7,589
15	20.75	7.25	56.4	7,352	15	25.00	9.00	73.3	8,368
15.5	21.25	7.50	59.4	8,039	15.5	25.75	9.25	77.5	9,299
16	22.00	7.75	63.2	8,506	16	26.75	9.50	82.6	9,820
16.5	22.75	8.00	67.2	9,812	16.5	27.50	9.75	87.1	11,451
17	23.50	8.25	73.7	10,799	17	28.50	10.00	95.7	12,593
17.5	24.25	8.50	78.1	10,884	17.5	29.25	10.50	101.2	12,502
18	24.75	8.75	81.7	11,209	18	30.00	10.75	106.4	12,936
18.5	25.50	9.00	88.3	11,733	18.5	31.00	11.00	118.0	13,630
19	26.25	9.25	97.7	12,981	19	31.75	11.25	129.5	14,977
19.5	27.00	9.50	102.8	14,737	19.5	32.75	11.50	136.5	17,020
20	27.75	9.75	108.1	15,265	20	33.50	12.00	143.3	17,579
20.5	28.50	10.00	113.5	15,719	20.5	34.25	12.25	149.6	18,066
21	29.00	10.25	126.0	17,262	21	35.25	12.50	167.3	19,857

Refer to Standard Drawings STD-17-107, use **H = 13 FT.**

$$H = \text{CELL HEIGHT} + ST = 12 \text{ FT} + 11.5 \text{ IN} \times (1 \text{ FT} / 12 \text{ IN}) = 12.96 \text{ FT, USE 13 FT}$$

		3 @ 18 x 12 REINFORCED CONCRETE BOX BRIDGE																																					
Maximum Fill Height ft	Dimensions					Bars TST			Bars TSB			Bars BST			Bars BSB			Bars EWE			Bars EWI			Bars IW			Bars LNT	Bars LND	Bars WS	Concrete CY/LF	Reinf Steel LB/LF								
	ST in.	SB in.	WT in.	IT in.	BW ft	Size	No.	Spacing in.	Length ft.	Size	No.	Spacing in.	Length ft.	Size	No.	Spacing in.	Length ft.	Size	No.	Spacing in.	Length ft.	Size	No.	Spacing in.	Length ft.	Size	No.	No.	No.										
No Fill	11.5	11	8	8	56.67	8	2	6	56.17	8	2	6	56.17	6	2	6	57.17	7	2	6	57.17	4	2	12	12.00	7	2	12	12.00	5	4	12	12.00	266	108	8	5.15	1477	
3	15	15	8	8	56.67	11	1	12	56.17	8	2	6	56.17	6	2	6	57.17	7	2	6	57.17	4	2	12	12.00	7	4	6	12.00	5	4	12	12.00	266	108	8	6.48	1525	
5	16	16	9	8	56.83	11	1	12	56.33	7	2	6	56.33	9	1	12	57.33	7	2	6	57.33	4	2	12	12.00	7	4	6	12.00	5	4	12	12.00	322	0	8	6.92	1445	
10	20	20	10	8	57.00	11	1	12	56.50	7	2	6	56.50	9	1	12	57.50	8	2	6	57.50	4	2	12	12.00	7	4	6	12.00	5	4	12	12.00	326	0	8	8.43	1522	
Moment Break	20	20	21	12	8	57.33	4	3	12	18.66	11	2	6	58.83	10	2	6	57.83	4	3	12	18.66	4	2	12	12.00	8	4	6	12.00	5	4	12	12.00	326	0	8	8.80	1695
	30	29	30	15	8	57.83	4	3	12	18.66	10	2	6	57.33	10	2	6	58.33	4	3	12	18.66	4	2	12	12.00	7	4	6	12.00	6	4	12	12.00	326	0	8	12.33	1581
	40	36	37	17	8	58.17	4	3	12	18.66	10	2	6	57.67	10	2	6	58.67	4	3	12	18.66	4	2	12	12.00	7	4	6	12.00	5	8	6	12.00	330	0	8	15.07	1617
	50	41	42	19	9	58.67	4	3	12	18.66	10	2	6	58.17	10	2	6	59.17	4	3	12	18.66	4	2	12	12.00	7	4	6	12.00	5	8	6	12.00	330	0	8	17.23	1626
	60	46	47	20	9	58.83	4	3	12	18.66	10	2	6	58.33	10	2	6	59.33	4	3	12	18.66	4	2	12	12.00	7	4	6	12.00	6	8	6	12.00	330	0	8	19.18	1673

Use Table from STD-17-107

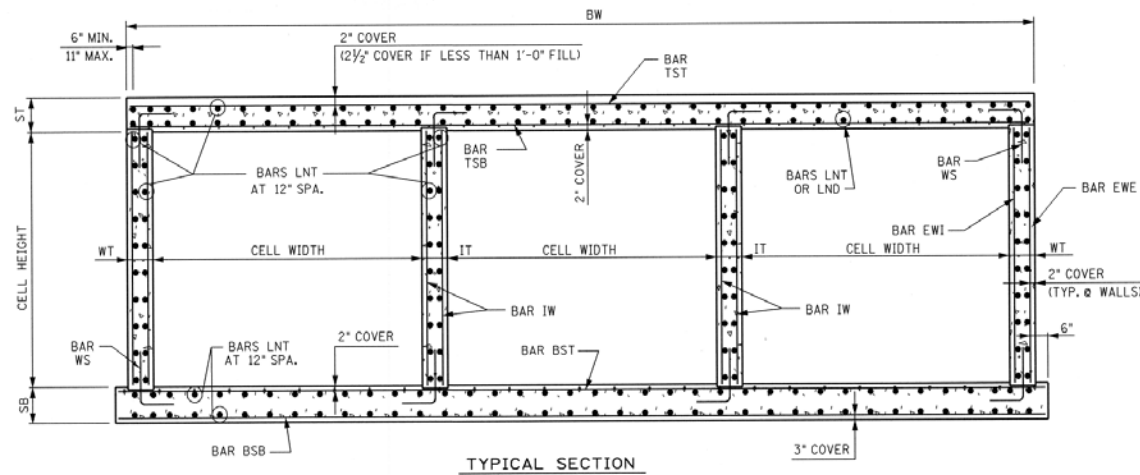

Use Typical Section from STD-17-107

Therefore,

Concrete = 39.4 CY

Reinforcing Steel = 5610 LB

*The quantities given in tables in Standard Drawing STD-17-11 are for **ALL FOUR WINGWALLS.***

Therefore,

TOTAL CONCRETE = 133.9 CY + 39.4 CY = 173.3 CY

TOTAL REINFORCING STEEL = 38402 LB + 5610 LB = 44012

Part 4 – Bridge Earthwork

Bridge excavation may be required for a project that includes a proposed bridge. This part will go into details of the calculations on how much earthwork will be required for the bridge excavation.

The designer will receive a hydraulic layout from the hydraulics division. This layout will detail any necessary bridge excavation that will be required for a project. If the project includes excavation, the layout will show a shaded area where the excavation will be needed. The excavation elevations will also be shown on the layout. For this project, the excavation at the beginning of the bridge will be to the elevation of 1100.11 and the excavation at the end of the bridge will be to the elevation of 1102.39. These elevations and excavation areas will vary based on project.

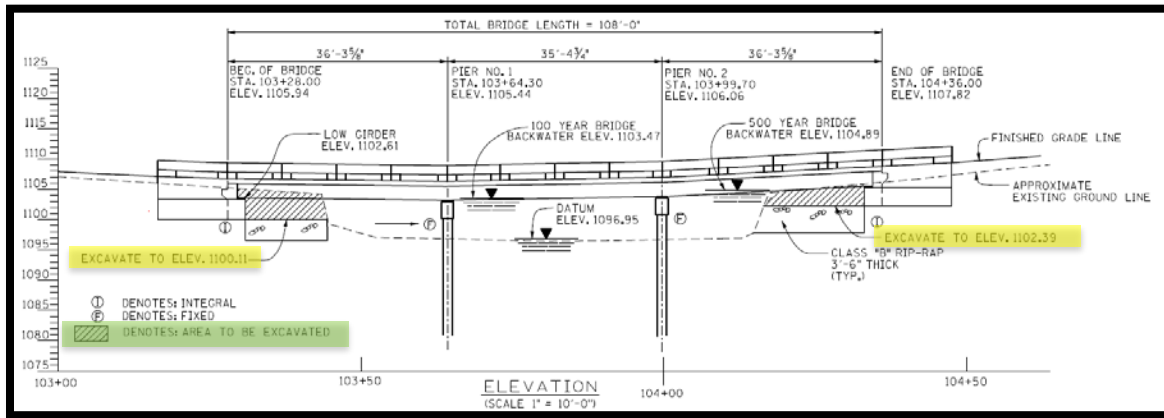

NOTE: In some cases, the hydraulic layout will not have the “excavate to this elevation” labeled. The Low-Girder Elevation can be used as a substitute. When using the low girder elevation, an additional 2-feet should be subtracted to allow for room for constructability. This new elevation can be treated as the excavation elevation moving forward in this example. An example of a hydraulic layout with the Low-Girder Elevation is shown below.

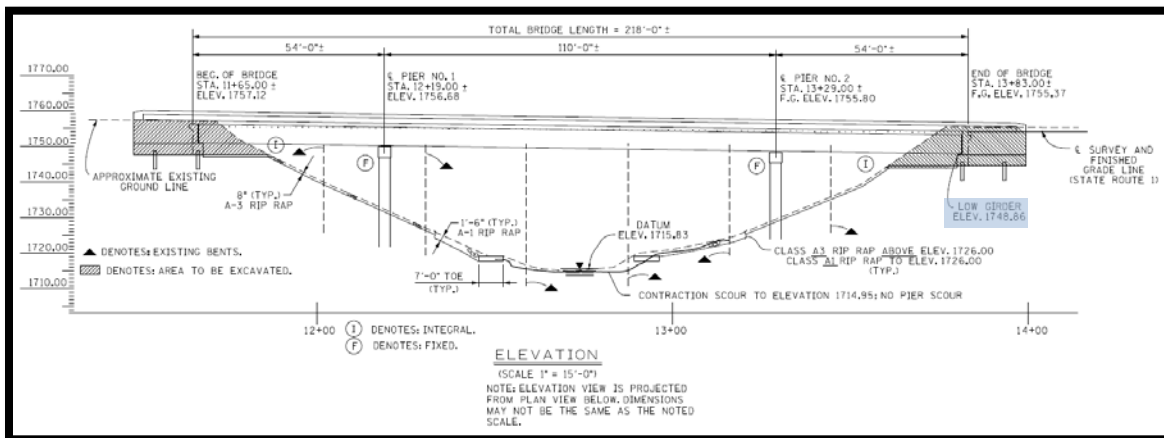

The process of calculating the earthwork includes creating new cross sections of the proposed bridge. The first step is to create a new DGN file for the new pattern lines. In this file, draw pattern lines at 5-foot increments along the proposed bridge stations. In this project, the proposed bridge is from Station 103+28 to Station 104+36.

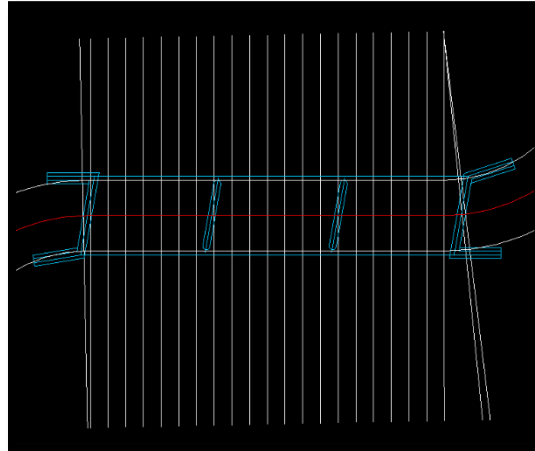

Next, create a new cross section DGN using the XS seed file. In this file, plot the 5-foot incremental cross sections along the proposed bridge. Its critical to understand this is not the same cross section file that is used to determine the project's overall earthwork quantity. The quantity that is calculated in this part have no influence with the project's earthwork quantity.

Looking back at the final hydraulic layout drawing, the beginning bridge excavation elevation is 1100.11. On the cross sections, the elevation of the bottom of the bridge deck need to be moved to the excavation elevation. Starting on Station 103+30, hand manipulate the existing bridge deck and move the line from its original elevation down to the elevation of 1100.11. This process is illustrated in the cross-section figures below.

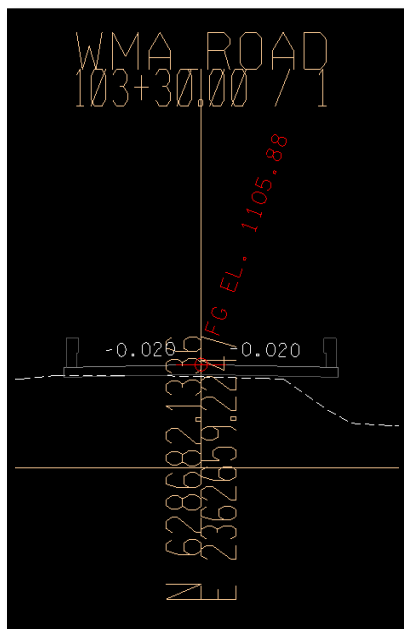

Before

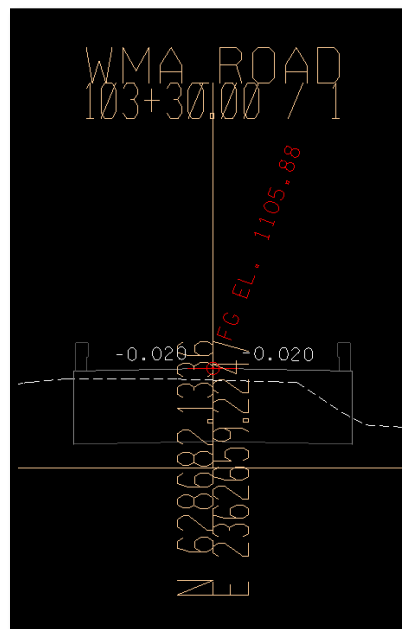

After

Continue this process on each cross section until the existing ground line is below the excavation elevation. The final cross sections should look like the ones in the figures below. These cross sections are only for the beginning of the bridge excavation. The process is the same for the end of the bridge, except for in this example, the excavation elevation is 1102.39.

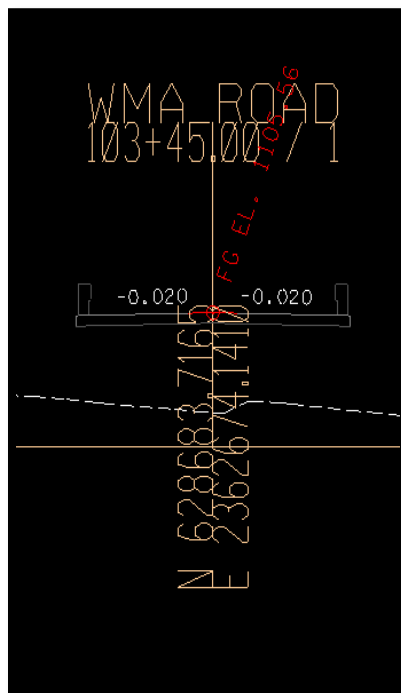
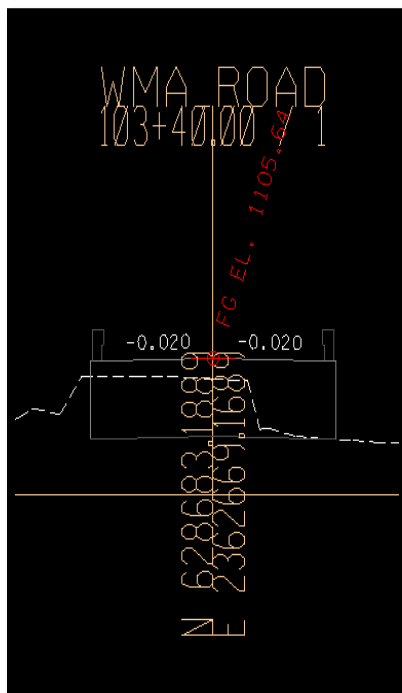
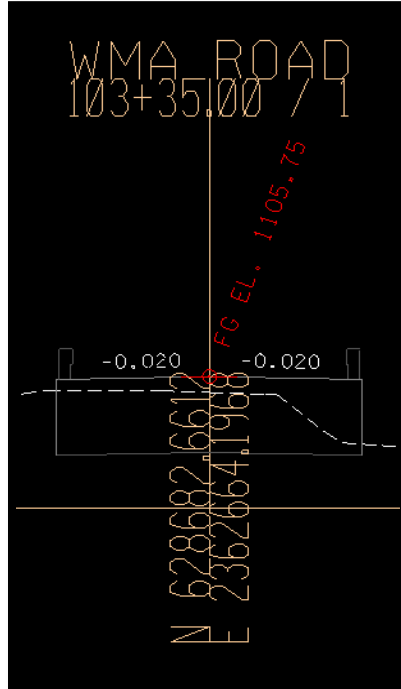
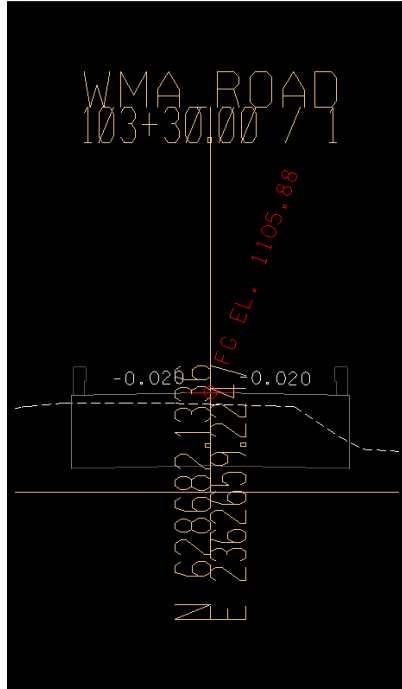

Once you have the bottom of the bridge deck at the excavation elevation for both ends of the bridge, the earthwork can then be ran to determine how much excavation is needed. This process is similar to how the project's overall earthwork is determined with a few minor changes. The earthwork run for the project's overall earthwork can be copied and renamed and then used for the bridge earthwork. The first revision would be to change the XS DGN File to the one that is currently being used and that was created earlier in this section.

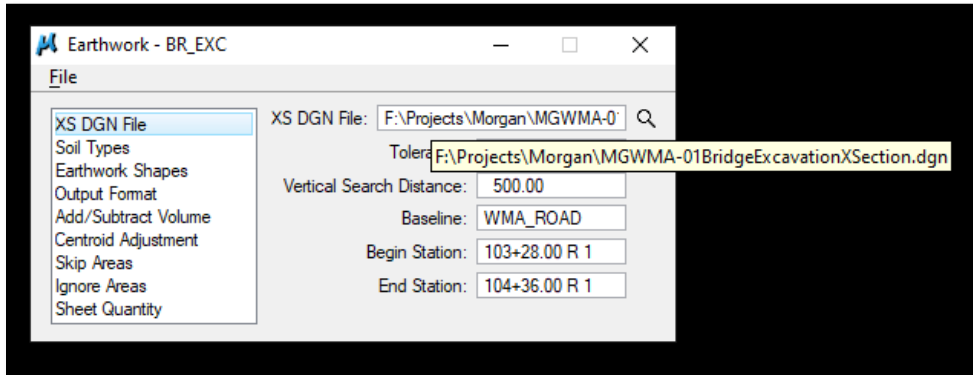

Next, the proposed finish grade soil type needs to be revised. Navigate down to Soil Types and select the Proposed Finish Grade. For simplicity, the level name can be selected and then matched to the level of the bridge deck, this level should be DESIGN – TYPICAL – Finish Grade and Subgrade. The Existing Ground soil type remains the same.

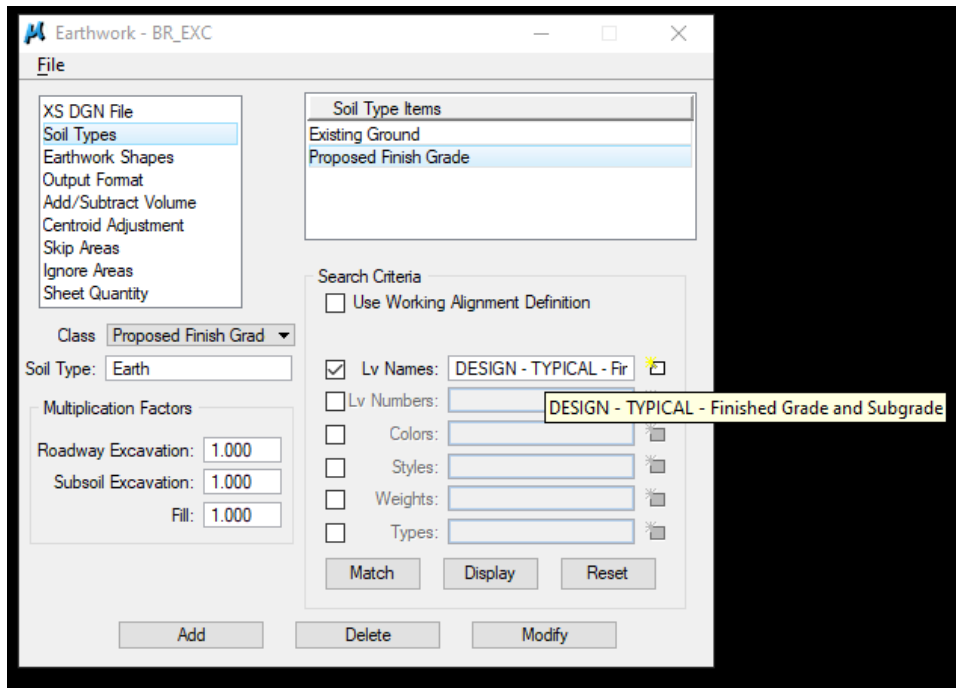

Next, if there was skipped area on the overall project's earthwork file, those need to be revised as well. The skip area and ignore area can be revised to the cross sections that required zero earthwork because the existing ground elevation was below the excavation elevations. For this example, it was from Station 103+45 to Sta. 104+10.

Lastly, in the Sheet Quantity section, the ASCII File name can be revised to be more specific to what is being calculated. The name can be revised to ProjectBridgeEarthwork.txt. The Log File name will need to be revised as well with a similar name.

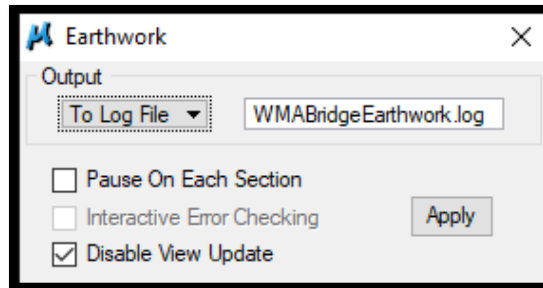
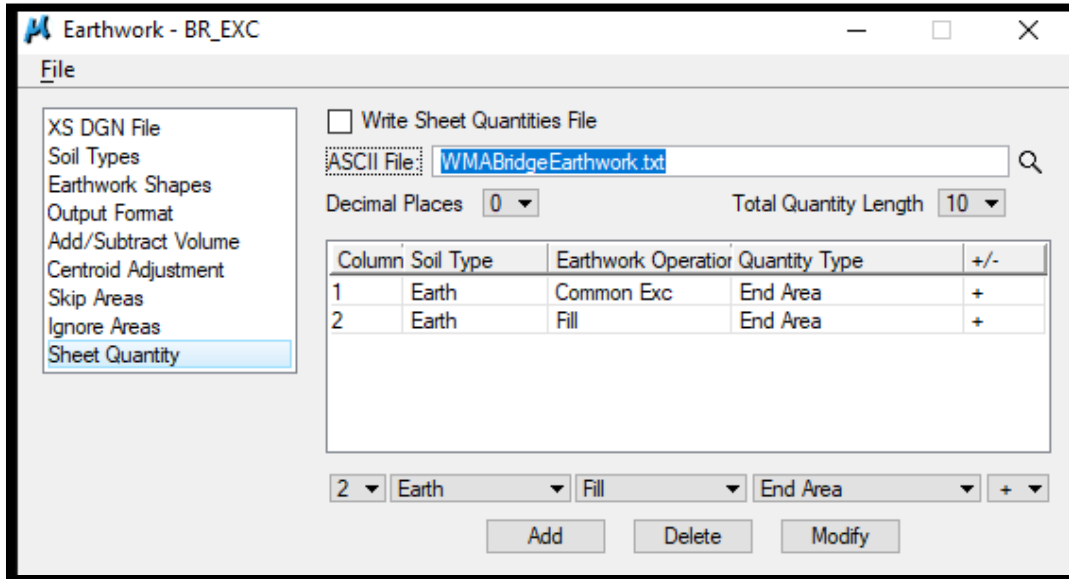

The earthwork can then be ran to calculate the amount of excavation that will be needed for the bridge excavation. The earthwork output is shown below.

Station	Material Name	End Areas (sq. ft.)	Unadjusted Volumes (cu. yd.)	Adjusted Volumes (cu. yd.)	Mult Factor	Mass Ordinate	Accum Unadj Vol (cu. yd.)	Accum Adj Vol (cu. yd.)
103+28.00	EARTH							
	Excavation	7	0	0	1.00		0	0
	Fill	17	0	0	1.00	0	0	0
103+30.00	EARTH							
	Excavation	102	4	4	1.00		4	4
	Fill	0	1	1	1.00	3	1	1
103+35.00	EARTH							
	Excavation	86	17	17	1.00		21	21
	Fill	0	0	0	1.00	20	1	1
103+40.00	EARTH							
	Excavation	64	14	14	1.00		35	35
	Fill	0	0	0	1.00	34	1	1
SKIP STATION RANGE = 103+45.00 to 104+10.00								
104+15.00	EARTH							
	Excavation	35	18	18	1.00		53	53
	Fill	0	0	0	1.00	52	1	1
104+20.00	EARTH							
	Excavation	79	11	11	1.00		64	64
	Fill	0	0	0	1.00	63	1	1
104+25.00	EARTH							
	Excavation	106	17	17	1.00		81	81
	Fill	0	0	0	1.00	80	1	1
104+30.00	EARTH							
	Excavation	125	21	21	1.00		102	102
	Fill	0	0	0	1.00	101	1	1
104+35.00	EARTH							
	Excavation	139	24	24	1.00		126	126
	Fill	0	0	0	1.00	125	1	1
104+36.00	EARTH							
	Excavation	1	3	3	1.00		129	129
	Fill	12	0	0	1.00	128	1	1
G R A N D S U M M A R Y T O T A L S								
	Material Name		Unadjusted Volumes (cu. yd.)	Adjusted Volumes (cu. yd.)	Mult Factor			
EARTH								
	Excavation		129	129	1.00			
	Fill		1	1	1.00			
S P L I T S U M M A R Y T O T A L S								
	Material Name		XS Quant Unadjusted Volume (cu. yd.)	XS Quant Adjusted Volume (cu. yd.)	Add/Sub Quant Unadjusted Volume (cu. yd.)	Add/Sub Quant Adjusted Volume (cu. yd.)	Mult Factor	
EARTH								
	Excavation		129	129	0	0	1.00	
	Fill		1	1	0	0	1.00	

It can be seen in the figure above that the excavation required is 129 CY. For some projects, a fill quantity may be calculated in this step. If this is the case, the fill quantity can be ignored. For this exercise, only the excavation quantity will be used. This quantity can then be added to the Estimated Grading Quantities Tabulated Block as shown in the figure below.

ESTIMATED GRADING QUANTITIES				
DESCRIPTION	UNADJUSTED VOLUMES (CY)		ADJUSTED VOLUMES (CY)	BALANCE SUMMARY
	EXC.	EMB.	EXC.	
MAINLINE	352	250	294	SHRINK = 20 % SWELL = 20 % EXC. EMB. 414 VS -282 AVAILABLE = 132 WASTE MATERIAL = 159
SIDE ROADS				
PVT. DRIVES, BUSINESS AND FIELD ENTRANCES				
INDEPENDENT DITCHES				
TEMPORARY CONSTRUCTION EXITS	15			
OTHER (BRIDGE EXCAVATION)	129			
PAVEMENT				
TOPSOIL (EMB.)				
TOPSOIL (EXC.)				
TOPSOIL (TO REPLACE STRIPPED TOPSOIL)		32		
ROCK (C.Y.)	TOTALS (C.Y.)			
EXC.	EMB.	EXC. (UNCL. EMB. (UNCL. EXC. (COMMON) EXC. (AVAIL.) EXC. (ADJ.)		
		496 282 496 414 414		

Part 5 – Backfill for Box Bridges and Culverts

When a Box Bridge or Culvert is required it may be necessary to excavate the existing channel in order to place the proposed structure. In that case backfill will be needed to fill the excavated area around the proposed structure. See Backfill Placement detail of Standard Structure Drawing STD-17-17 below. This part will illustrate the method for calculating culvert excavation, backfill and foundation fill.

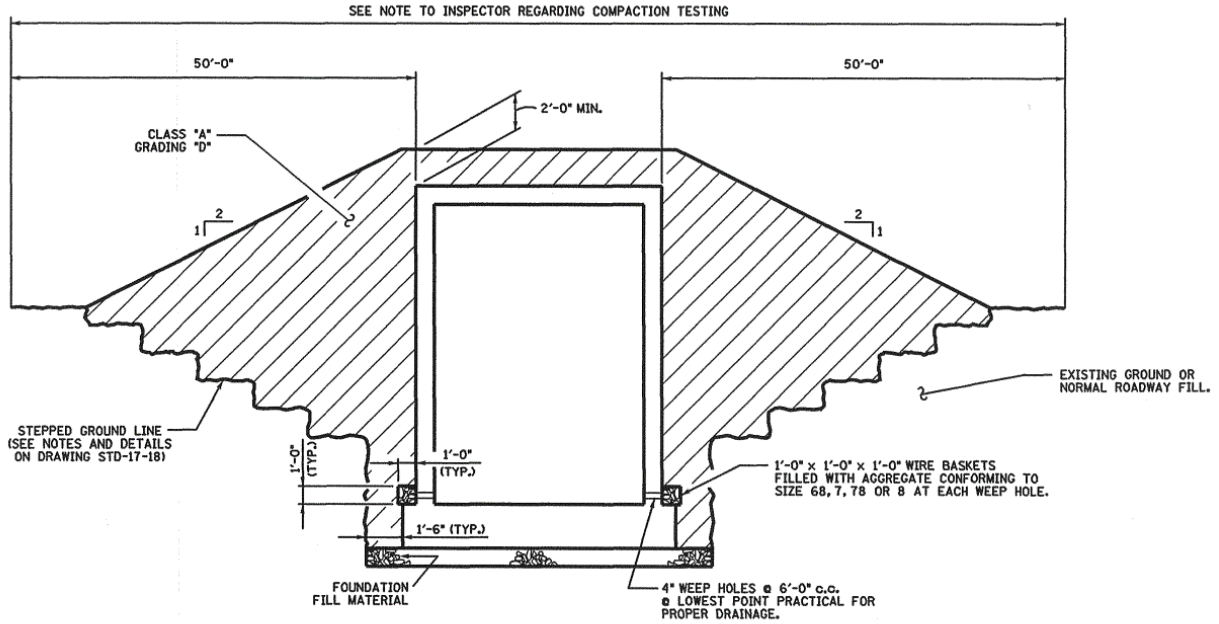

BACKFILL PLACEMENT

(BOX CULVERT SHOWN; SLAB BRIDGES SIMILAR)

NOTE: CLASS "A" GRADING "D" LIMITS ARE TYPICAL FOR BOX CULVERT OR BRIDGE AND WINGWALLS.

Example: Proposed 18' x 7' Box Bridge located at Sta. 864+95.42. The length of the proposed structure is 112' at skew of 87° 14' 48" Lt.

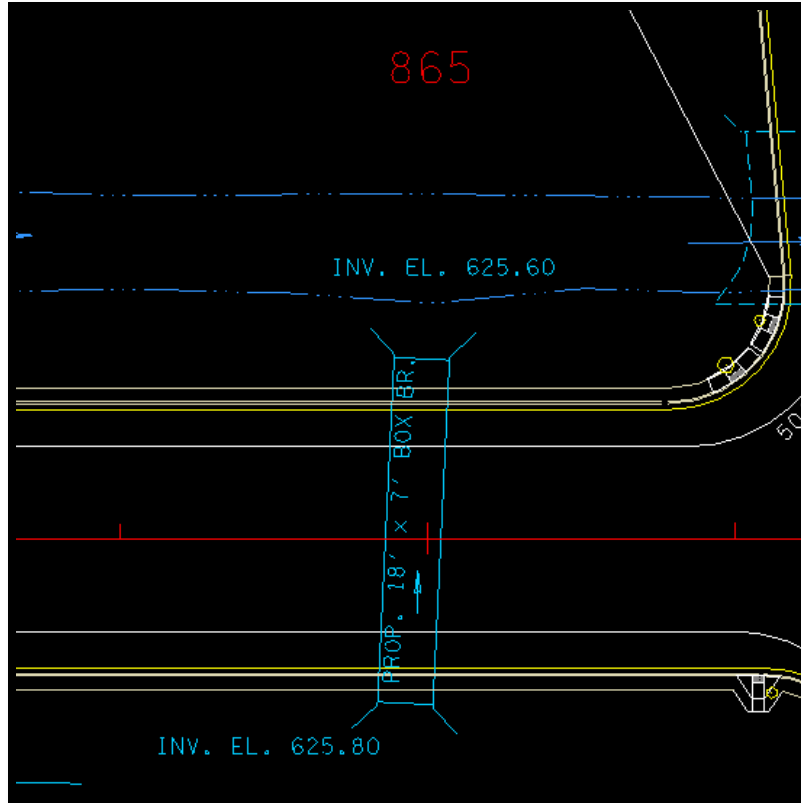

Plan view of Proposed Box Bridge

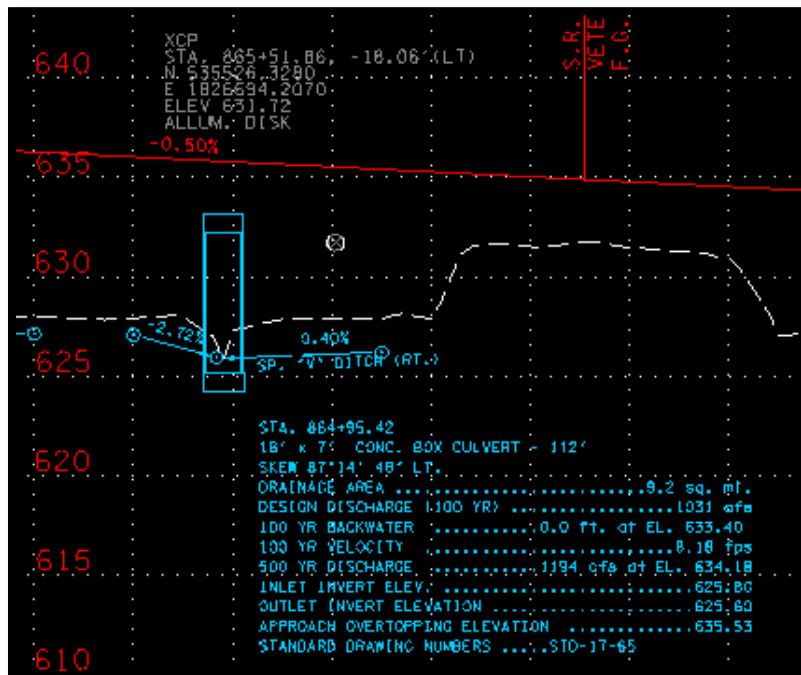

Profile view of Proposed Box Bridge

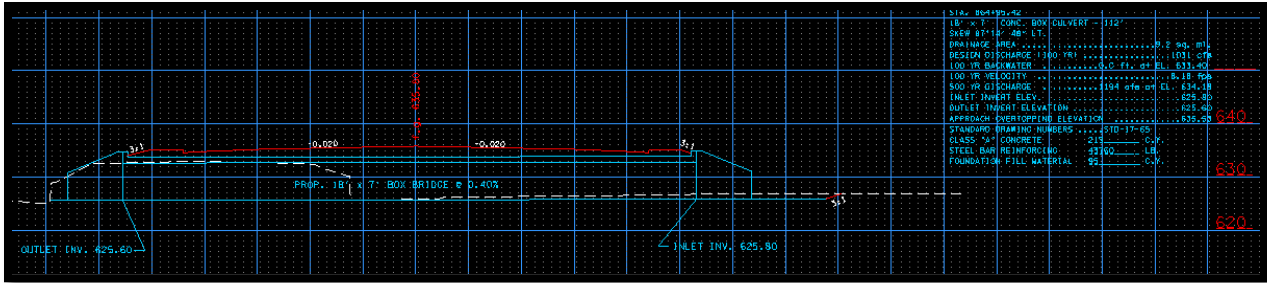

Culvert section of Proposed Box Bridge

In the Roadway Design Guidelines Section 4-204.05, Figure 4-14 illustrates the limits of culvert excavation for both a box and a slab type bridge. To calculate the excavation and backfill, first it will be necessary to cut cross sections of the existing channel or ground line perpendicular to the center line of the proposed box bridge or culvert.

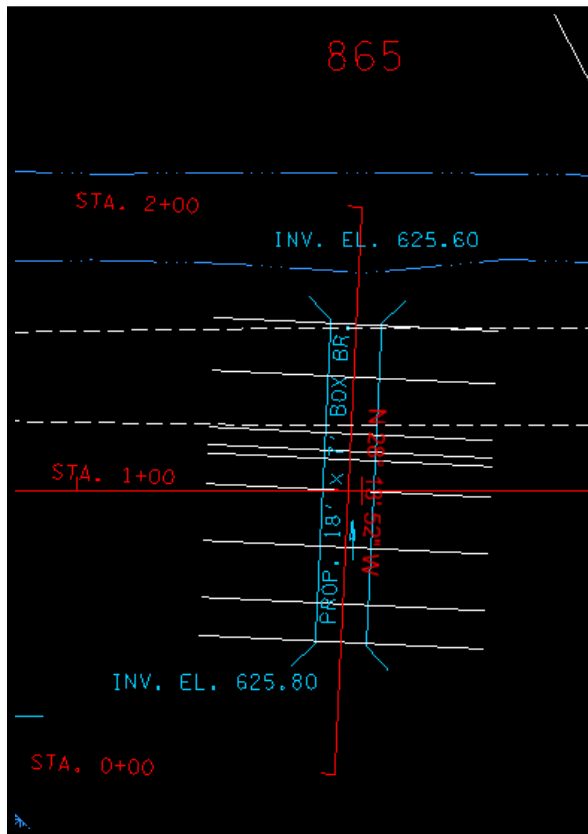

Plan view of Proposed Box Bridge w/ Pattern Lines

In the figure above, a line has been drawn corresponding to the centerline of the structure. To facilitate the cutting of existing cross sections the red line has been stored as an alignment in Geopak. Pattern lines have been drawn at each end of the culvert and at 20' intervals in between. From the cross section on the previous page, it can be seen that the right edge of the

existing roadway is approximately 12.5' left of the proposed roadway centerline. Two additional pattern lines have been drawn on either side of the roadway edge. These pattern lines define where the existing cross section lines will be cut.

Once the cross sections have been cut, from the TDOT menu draw the proposed culvert cell on each cross section (T.D.O.T. > Drainage (Profiles/Culv.Sections) > Draw Box Culvert or Br).

Fill in the data as applicable (numbers shown are for this example culvert):

Refer to Standard Drawings found at this link for dimensions of Box culverts and Bridges:

[LRFD Box Culverts](#)

Category	Field	Value
Barrels	Number of Barrels	1
	Barrel Width	18
	Barrel Height	7
Thickness	Outside Wall	8
	Inside Wall	8
	Top Slab	12
	Bottom Slab	12
Skew	Skew Angle	87°14'48"
	Skew Direction	Left
	Label Scale	10
Vertical	Vertical Exaggeration	1
	Enter barrel sizes in feet or meters and thicknesses in inches or millimeters.	

Place the cell at the flow elevation corresponding to the section. The section shown below is the right (inlet) end where the flow elevation is 625.80.

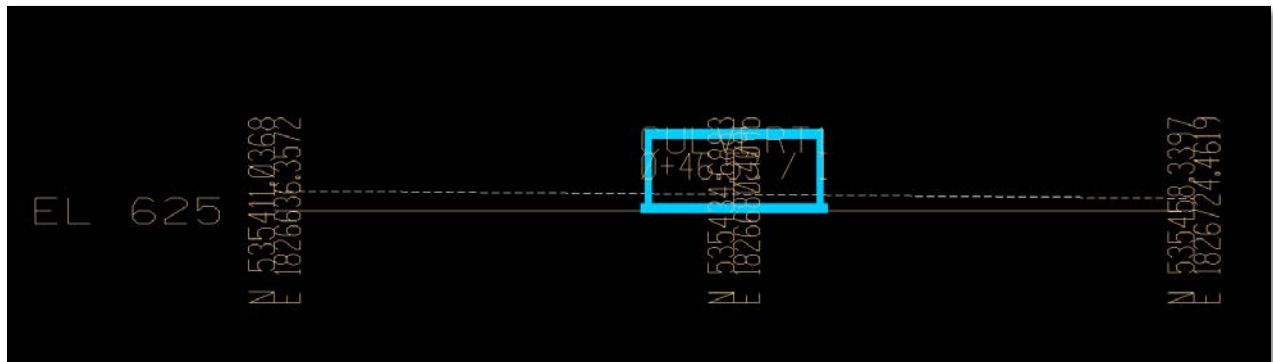

This section is the left (outlet) end of the culvert. The flow elevation is 625.60:

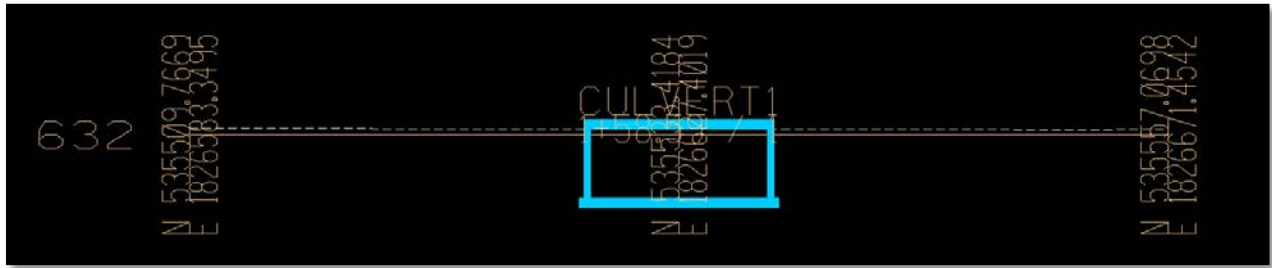

Do the same for all sections in between.

Referencing Figure 4-14 of the Roadway Design Guidelines from Section 4-204.05, the culvert excavation area can be drawn:

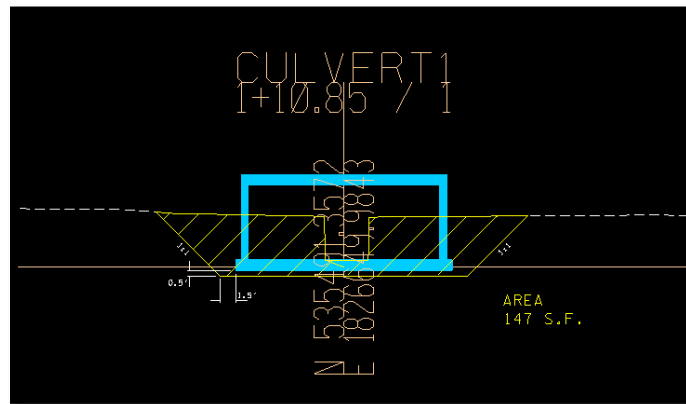

Section showing Culvert Excavation

When the culvert excavation area is known then the backfill area can be drawn as shown:

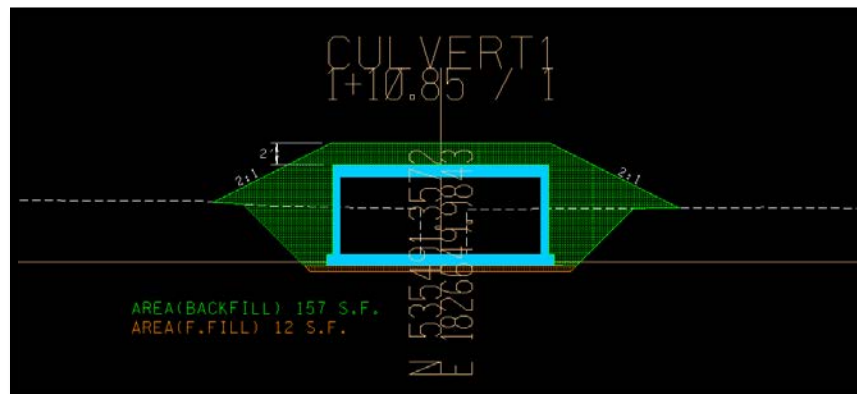

Section showing Backfill

With the culvert excavation and backfill areas determined; the volumes can be calculated. An Excel file is a good way to do this:

Station	Dist.	Flow Elev.	Culvert Exc.		Backfill		Found.Fill	
			Area Sq. ft.	*Volume Cu. Yd.	Area Sq. ft.	*Volume Cu. Yd.	Area Sq. ft.	*Volume Cu. Yd.
0+46.53		625.80	63		217		12	
	13.47			30.18		108.01		5.99
0+60.00		625.78	58		216		12	
	20.00			41.48		160.37		8.89
0+80.00		625.75	54		217		12	
	20.00			47.78		148.89		8.89
1+00.00		625.73	75		185		12	
	10.85			44.61		68.72		4.82
1+10.85		625.70	147		157		12	
	3.00			18.67		17.11		1.33
1+13.85		625.68	189		151		12	
	6.15			50.91		34.96		2.73
1+20.00		625.66	258		156		12	
	20.00			200.37		117.41		8.89
1+40.00		625.63	283		161		12	
	18.59			190.03		109.82		8.26
1+58.59		625.60	269		158		12	
Total	112.06			624.02		765.29		49.80

*Volume = (Area1+Area2)/2 * Dist) /27

In this example the backfill volume is 765 C.Y., therefore the quantity for Item No. 303-01.01 Granular Backfill (Roadway) is:

765 c.y. x 1.75 tons/c.y. = 1339 tons

In this example the quantity for Item No. 204-08 Foundation Fill Material is 50 C.Y.

The first step is to locate the position of the rip-rap for the bridge apron. The dimensions and elevations constraints of the rip-rap are highlighted in the figures below. The red highlighted area is Class A-1 rip-rap and the yellow highlighted area is Class A-3 rip-rap. More information on the specific details of each rip-rap class can be found in the [2021 TDOT Standard Specifications Book, Section 709.03](#).

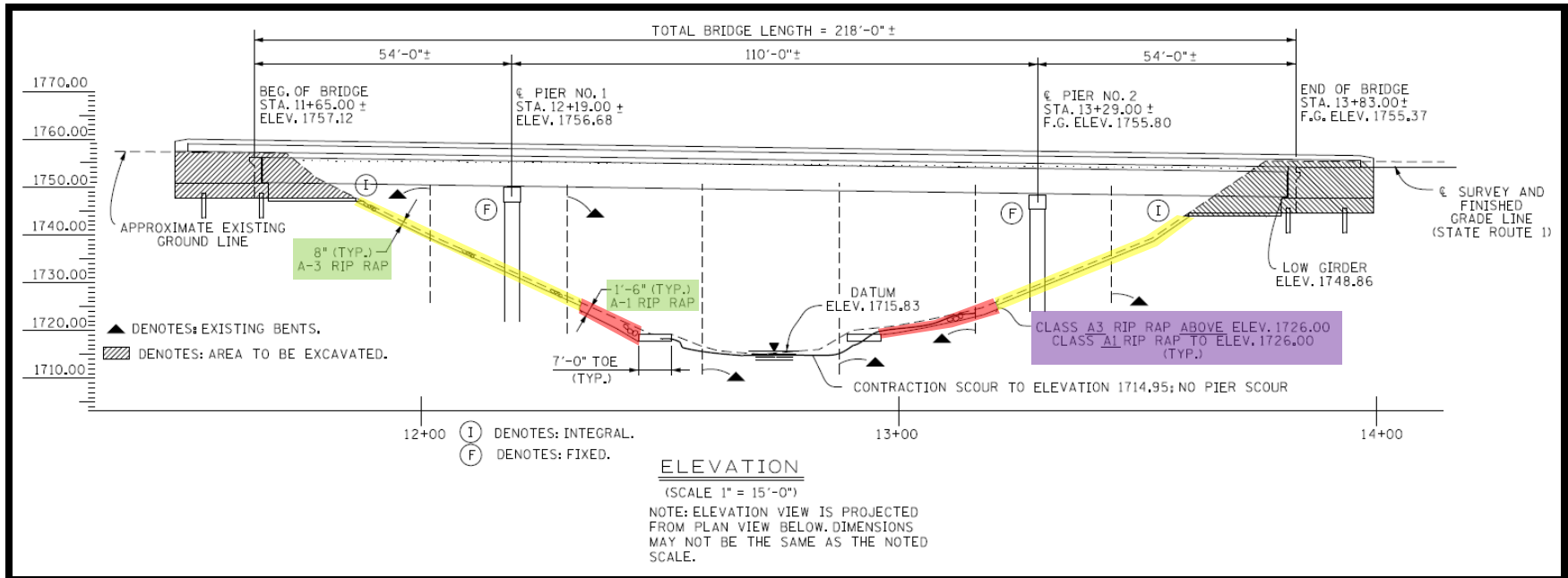

Elevation View

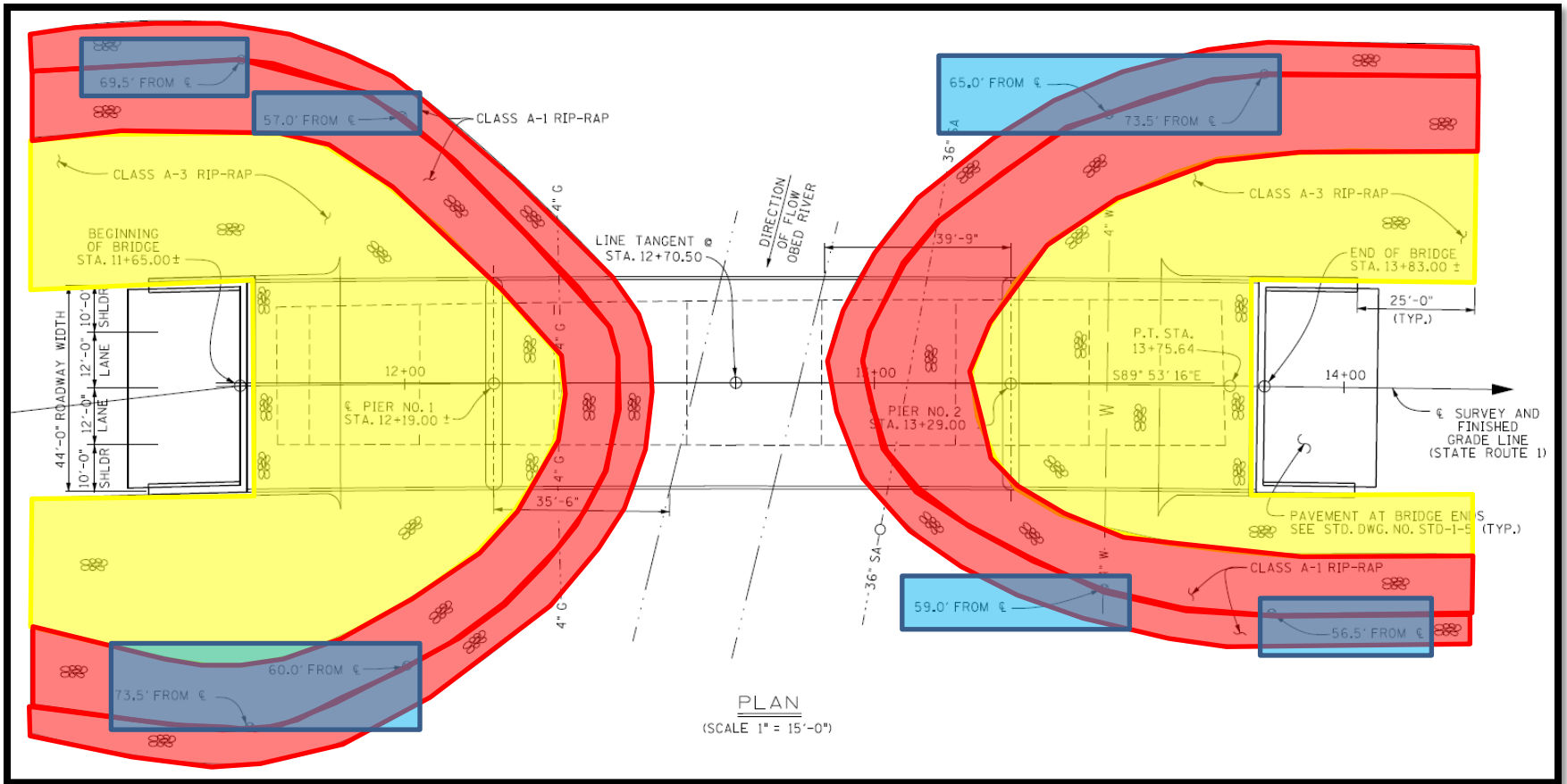

Plan View

Once the location of rip-rap is determined, the designer can begin to draw the rip-rap shapes into the project's Proposed DGN. Using the offsets and elevations, the approximate locations of each riprap class can be plotted, see the blue highlight in the **Plan View** and the purple view in the **Elevation View**. The final plotted shape can be seen in the figure below. Labels can be added to easily identify the two different types of rip-rap.

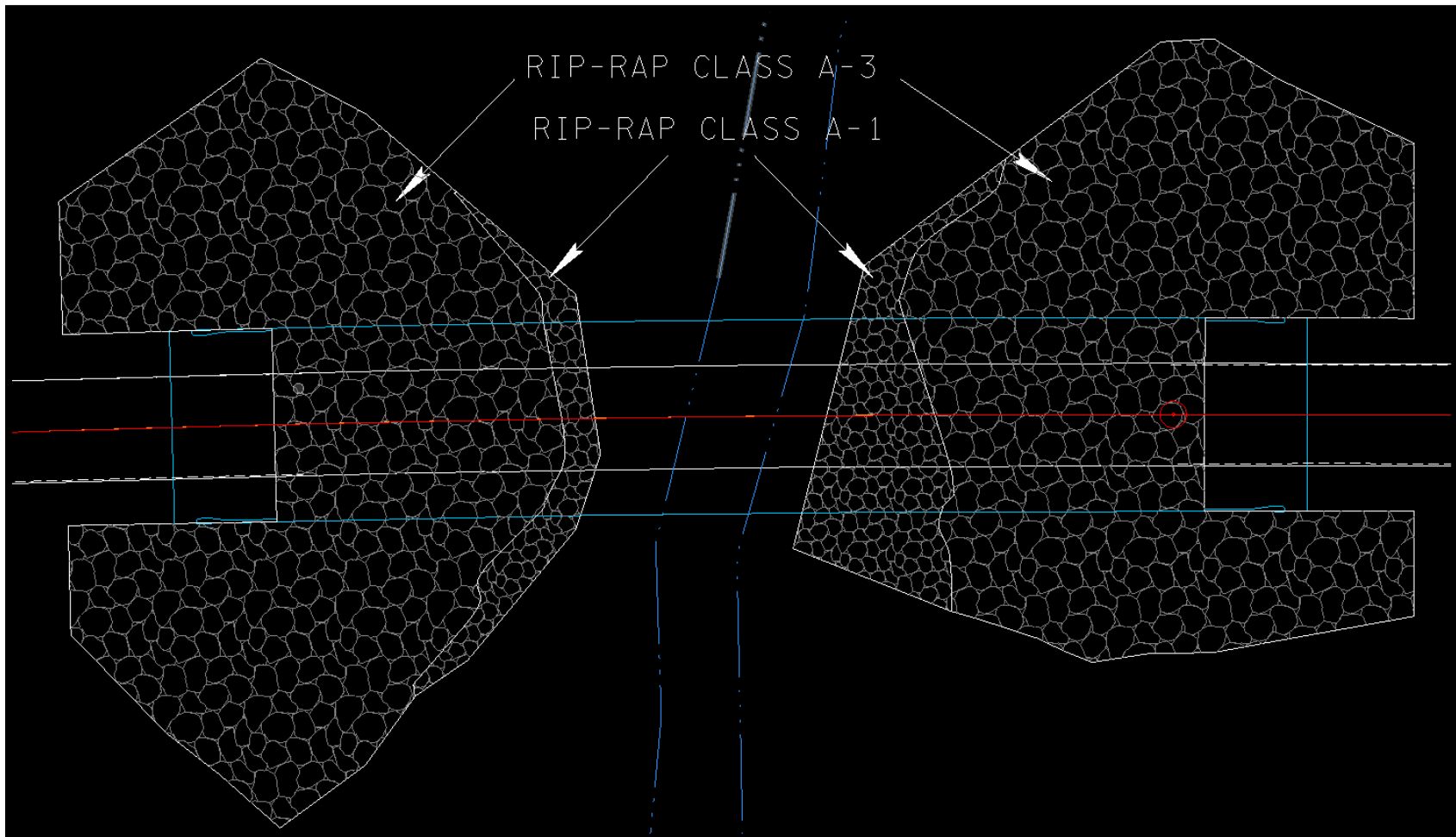

Plan View in Proposed DGN

After the rip-rap is plotted in the Proposed DGN, the area of each class of rip-rap can be calculated. Use the Measure Area tool below to calculate the surface area of each class of rip-rap.

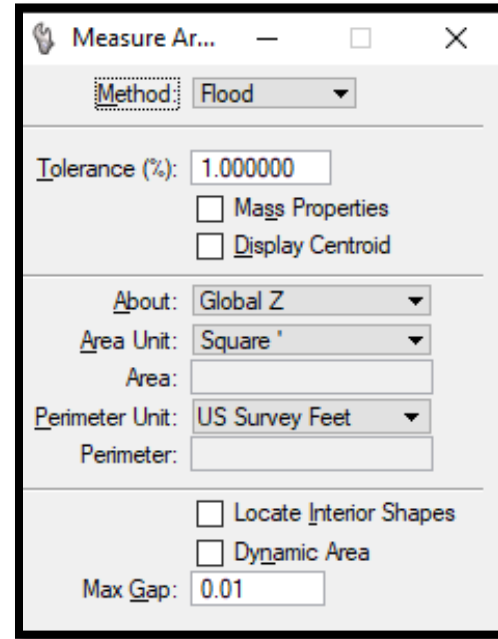

The table below summarizes the total surface area of riprap for both class A-1 and A-3.

Rip-rap Surface Area

	Class A-1 Rip-rap (Square Feet)	Class A-3 Rip-rap (Square Feet)
Beginning Bridge	933	12631
End Bridge	1981	11822
Totals	2914	24453

After the surface area is calculated, the depth of the rip-rap needs to be determined. As highlighted in green in the **Elevation View** figure above, the depth of the Class A-1 rip-rap is 1.5 ft and the depth of the Class A-3 rip-rap is 0.67 ft. Once the depth is determined, the volume of rip-rap can be calculated in cubic yards and then converted to tons. A summary of this process is shown in the table below. The conversion from cubic yards to tons can be found in the Roadway Design Guidelines Section 4-709.05 or in the equation below.

$$\text{Computed Quantity (C.Y.)} \times 1.75 \text{ Tons/C.Y.} = \text{Total (Tons)}$$

Rip-rap Volumes & Tons

	Total Surface Area (SF)	Depth (FT)	Volume (CY)	Total (TONS)
Class A-1 Rip-rap	2914	1.50	162	283
Class A-3 Rip-rap	24453	0.67	604	1057

The total quantity for each type of riprap can be shown in the plans as follows:

- 709-05.05 MACHINED RIP-RAP (CLASS A-3) **1057 TONS**
- 709-05.06 MACHINED RIP-RAP (CLASS A-1) **283 TONS**