



SURVEY STANDARDS MANUAL

Roadway Design Division

Fourth Edition

October 2023

Table of Contents

Table of Contents	i
Preface.....	x
Chapter 1. Introduction and General Information	1
1.1 Organization.....	1
1.2 Public Relations	2
1.2.1 General.....	2
1.2.2 Questions from the Public.....	2
1.2.3 Property Owners.....	2
1.2.4 Pre-Entry Contact	2
1.2.5 Objection to Entry	3
1.3 Legal Aspects	3
1.3.1 Right to Enter Private Property.....	3
1.3.2 Claims for Damage to Private Property	3
1.3.3 Citizen’s Right to View Documents	3
1.3.4 Right to Control Traffic During Survey	4
1.4 Safety.....	5
Chapter 2. Survey Control.....	6
2.1 Project Control (General)	6
2.1.1 Horizontal.....	6
2.1.2 Vertical.....	7
2.1.3 Survey Datums and the Tennessee Grid System	8
2.2 Accuracy and Errors	13
2.2.1 Accuracy and Precision	13
2.2.2 Order of Accuracy.....	14
2.3 Project Control (GNSS Procedures)	19
2.3.1 Pre-Planning	19
2.3.2 Reconnaissance	19
2.3.3 Receiver Setup Procedures	19
2.3.4 Observation Methods.....	20

Table of Contents

2.3.5 Traverse Method.....	21
2.3.6 Wing Point Method	22
2.3.7 RTK Method.....	23
2.3.8 Post-Processing Static Data	25
2.3.9 TDOT Control Point Database Use.....	26
2.4 Aerial Survey Control	26
2.4.1 Traverse / GNSS Point Annotation	26
2.5 Ground Control Preparation	27
2.5.1 Pre-Flight Targeting	27
2.5.2 Horizontal Control	27
2.5.3 Vertical Control	29
Chapter 3. Aerial Surveys and Mapping.....	30
3.1 Correspondence	30
3.2 Standard Parameters.....	30
3.3 Aerial Mission.....	31
3.4 Image Products.....	33
3.5 Analytical Aerial Triangulation.....	33
3.6 Digital Mapping File Requirements	34
3.7 Map Compilation Techniques.....	34
3.8 Map Content	35
3.8.1 Control Points	35
3.8.2 Planimetric Detail.....	35
3.8.3 Topographic Detail.....	36
3.9 Digital Terrain Model Production.....	36
3.10 Map Accuracy Standards	37
Chapter 4. Surveying Procedures and Practices.....	39
4.1 Development of Survey CADD Files	39
4.1.1 General.....	40
4.1.2 The Planimetric File	41
4.1.3 The Digital Terrain Model.....	43
4.2 Final Alignment and Topography	44

Table of Contents

4.2.1 Alignment.....	44
4.2.2 Curves	44
4.2.3 Tangents.....	44
4.2.4 Staking Final Alignment	45
4.2.5 Reference Points	45
4.3 Topography.....	45
4.3.1 General.....	45
4.3.2 At Grade Road Crossings	46
4.3.3 Property Lines.....	46
4.3.4 Present Right-of-Way	48
4.3.5 Land Character	50
4.3.6 Existing Drainage Structures	50
4.3.7 Buildings	50
4.3.8 Ramps and Driveways.....	51
4.3.9 Underground Petroleum Storage Tanks	51
4.3.10 Other Topographic Features.....	52
4.3.11 Field Notes.....	52
4.3.12 Plotting.....	52
4.4 Bench Levels and Check Levels	52
4.4.1 Vertical Datums	52
4.4.2 Methods and Accuracy	53
4.4.3 Benchmark Location	53
4.4.4 Descriptions	53
4.5 Profile and Cross Sections.....	53
4.5.1 Procedures	53
4.5.2 Profile Plotting.....	54
4.6 Drainage Surveys	55
4.6.1 Drainage Areas.....	55
4.6.2 General Requirements for Bridge and Culvert Surveys	56
4.7 Drainage Site Surveys	56
4.8 Bridge Surveys.....	56

Table of Contents

4.8.1 Stream Baseline Alignment.....	56
4.8.2 DTM Development.....	57
4.8.3 Topography.....	57
4.8.4 Stream Profile.....	58
4.8.5 Questions.....	58
4.8.6 ORD Deliverables.....	59
4.9 Pipe and Box Culvert Surveys.....	59
4.9.1 Topographic Surveys.....	59
4.9.2 DTM.....	59
4.9.3 Text.....	60
4.9.4 Erosion Control.....	60
4.10 Property Map.....	60
4.10.1 Procedures.....	60
4.10.2 Sources of Information.....	60
4.10.3 Map Limits.....	60
4.10.4 Tract Numbers.....	61
4.10.5 R.O.W. Acquisition Table.....	61
4.11 Grade Separations (Roadway).....	61
4.11.1 Field Data Required.....	61
4.11.2 Plotting.....	61
4.12 Railroad.....	62
4.12.1 Field Data Required.....	62
4.12.2 Plotting.....	63
4.13 Bridge Widening.....	64
4.13.1 Bridge Widening Projects.....	64
4.14 Other Surveys.....	64
4.14.1 Staking Right-of-Way.....	64
4.14.2 Staking Sounding Holes.....	65
4.14.3 Additional Surveys.....	66
4.14.4 Updates.....	66
Chapter 5. Care and Maintenance.....	67

Table of Contents

5.1 TDOT	67
5.1.1 General	67
5.1.2 Total Stations and Levels.....	67
5.1.3 Total Stations.....	68
5.1.4 Tripods, Level Rods, and Other Equipment	68
5.1.5 Global Navigation Satellite System (GNSS) Equipment	69
5.1.6 Adjustments	69
5.2 Consultants	69
Chapter 6. General Survey Information and Consultant Coordination	70
6.1 Design Criteria and Standard Drawings Pertaining to Surveys	70
6.1.1 General	70
6.1.2 Alignment Criteria Given	70
6.1.3 Design Criteria	70
6.2 Report and Correspondence	71
6.2.1 Survey Transmittal Letter.....	71
6.2.2 Survey Checklist	71
6.3 Field Books	71
6.3.1 General.....	71
6.3.2 Benchmark Levels	71
6.3.3 Profile Notes	71
6.4 Horizontal and Vertical Measurements	71
6.4.1 Linear Measurement.....	71
6.4.2 Angular Measurement	72
6.4.3 Vertical Measurement.....	72
6.5 Coordination of Consultant Survey Projects.....	72
6.5.1 General.....	72
6.5.2 Contacts.....	72
6.5.3 Estimates	73
6.5.4 Delivery Procedures	74
Chapter 7. Remote Sensing	75
7.1 Terrestrial Scanning	75

Table of Contents

7.1.1 Stationary Terrestrial Laser.....	75
7.1.2 TLS Application.....	76
7.1.3 TLS Project Selection	76
7.1.4 TLS Equipment and Use.....	77
7.1.5 TLS Specifications and Producers.....	79
7.1.6 TLS Deliverables and Documentation	82
7.2 Mobile Mapping and Scanning.....	85
7.2.1 Type A – High Accuracy Surveys	85
7.2.2 Type B – Medium Accuracy Surveys	85
7.2.3 Type C – Lower Accuracy Mapping	86
7.2.4 MLS Project Selection	86
7.2.5 MLS Equipment	86
7.2.6 MLS Project Specifications and Procedures	87
7.2.7 MLS Deliverables and Documentation.....	93
7.3 UAS Aerial Mapping.....	97
7.3.1 UAS Photogrammetry / Structure from Motion.....	98
7.3.2 UAS LiDAR	101
7.3.3 Ground Control Point Design and Material	101
7.3.4 UAS Aerial Control Survey Report.....	103
Chapter 8: Subsurface Utility Engineering (SUE).....	105
8.1 Utilities	105
8.1.1 Owners	105
8.1.2 Limits	105
8.1.3 Location and Profile	105
8.1.4 Underground.....	106
8.1.5 Overhead.....	106
8.1.6 Signals.....	106
8.1.7 Pole or Tower Number.....	106
8.1.8 Type of Utility	107
8.1.9 Storm Sewers and Sanitary Sewers	107
8.1.10 Septic and Drain Fields.....	107

Table of Contents

8.1.11 Wells	107
8.1.12 Location for Pay Item Purpose.....	108
8.1.13 Problems.....	108
Chapter 9. Deliverables.....	109
9.1 DGN Files	109
9.2 Checklists / Forms	110
9.3 Supplemental Files	110
Revision History	111
Appendix A. TDOT Survey Feature Codes	112
A.1 Transportation Features	123
A.2 Non-Transportation Features.....	130
A.3 Drainage	135
A.4 R.O.W. / Property	144
A.5 Political Boundaries	146
A.6 Utilities.....	147
A.7 Vegetation	160
A.8 Traffic Control.....	161
A.9 Traffic Control (Pavement Marking).....	168
A.10 Terrain Model	171
A.11 Survey Control.....	172
A.12 Miscellaneous & Default Codes.....	173
A.13 Office Codes.....	175
A.14 Photos	176
A.14.1 Road Photo 1	176
A.14.2 Road Photo 2	177
A.14.3 Road Photo 3	177
A.14.4 Road Photo 4	178
A.14.5 Road Photo 5	178
A.14.6 Box Culvert Photo 1	179
A.14.7 Box Culvert Photo 2	180
A.14.8 Creek Photo 1	180

Table of Contents

A.14.9 Bridge Photo 1.....	181
A.14.10 Bridge Photo 2.....	181
A.14.11 Bridge Photo 3.....	182
A.14.12 Bridge Photo 4.....	182
A.14.13 Utility Photo 1	183
A.14.14 Utility Photo 2	183
Appendix B. TDOT Occupational Health & Safety Div: Instructional & Info Memo	184
Appendix C. Figures and Tables	192
C.1 Property Owner Contact Forms and Letters	192
C.1.1 Contact Form	192
C.1.2 Contact Letters (Aerial, Geotechnical, ROW, Survey).....	192
C.2 R.O.W. Acquisition Tables.....	192
C.3 Tennessee Reservoirs.....	193
C.4 Present Layout Sheets	194
C.4.1 Example 1	194
C.4.2 Example 2	195
C.4.3 Example 3	196
C.5 Profiles	197
C.5.1 Example 1	197
C.5.2 Example 2	198
C.5.3 Example 3	199
C.6 Drainage Maps	200
C.6.1 Example 1	200
C.7 Survey Standards.....	201
C.7.1 Horizontal Example	201
C.7.2 Vertical Example	202
C.8 Field Notes	203
C.8.1 Example 1	203
C.8.2 Example 2	204
C.8.3 Example 3	205
C.8.4 Example 4	206

Table of Contents

C.9 Aerial Survey Target, Block Imagery and Strip Imagery	207
C.9.1 Example 1	207
C.10 Preliminary Bridge Drawing (Table).....	208
C.10.1 Example 1	208
C.11 NOAA Manual NOS NGS 5	209
C.11.1 Excerpt 1	209
C.11.2 Excerpt 2	210
C.12 Bridge Sketch	211
C.12.1 Example 1	211
C.12.2 Example 2	212
C.12.3 Example 3	213
C.12.4 Example 4	214
C.13 Surveying Methods.....	215
C.13.1 Traverse	215
C.13.2 Wing Point.....	216
C.13.3 Modified Wing Point	217
C.14 County Codes.....	218
C.15 Hydrologic Areas	220
C.15.1 Example 1	220
C.16 Roadway Breakline Placement.....	221
C.16.1 Two Lane-Two Way Example	221
C.16.2 Multilane Divided Example	222
C.17 QA/QC Reports	223
C.17.1 TLS Checklist	223
C.17.2 MLS Checklist	224
C.18 Point Cloud Deviation Map Example	225
C.19 RMSE Report Example	226

Preface

Purpose & Need

The purpose of this manual is to provide uniform guidelines for implementing survey practices with the Tennessee Department of Transportation (TDOT) both internally within the department and to be utilized as a guide for consultants as extensions of the Tennessee Department of Transportation (TDOT). This survey manual will ensure quality and continuity in the collection and mapping of all aspects of survey data. The objective of this manual is to serve as a guide to fit the many different methodologies of survey data collection to include project control, GNSS, Aerial Surveys, Remote Sensing, Terrestrial Scanning, Mobile Mapping and Scanning, UAS Aerial Mapping, and Subsurface Utility Engineering (SUE).

This manual details the many different technical aspects of the surveying practice but also includes the legal aspects, public relations, care and maintenance of equipment and safety which can never be overlooked and is paramount to the success of the Department.

Due to the rapid technological developments in the practice of the surveying discipline this manual references many checklists, forms, diagrams and websites which will be maintained by the Department to ensure these references remain up-to-date and relevant with the technological advancements within our industry.

The criteria included in this manual have been developed along the lines of various other State's survey manuals, as well as in conformance with applicable Department directives, policies and procedures.

Disclaimer

The **Survey Standards** Manual is developed based on OpenRoads Designer CONNECT Edition 2022 Release 1, Version 10.11.00.115. The TDOT ORD workspace (10.11.00.115_07.24.2023) complies with the latest CADD standards and should be used in conjunction with this manual. It can be downloaded on the TDOT CADD Support website under [ORD Resources](#). If you have any technical issues or recommendations for this manual, please contact TDOT CADD Support at TDOT.ORD@tn.gov.

Revisions

The **Survey Standards** Manual will be revised over time as a result of future TDOT Survey and software advancements. All revisions will be documented by WSP/TDOT and included on the **Revision History** page at the end of the manual.

Chapter 1. Introduction and General Information

This Manual has been developed to serve as a guide for all persons involved in the performance of engineering surveys for the Tennessee Department of Transportation (TDOT). The Manual establishes minimum acceptable standards of accuracy and completeness and will help to assure uniformity of method and product statewide.

The Manual is intended as a reference, not as a textbook or contract document. The Manual is not intended as a substitute for surveying knowledge, experience, or judgment. Although portions include textbook material, the Manual does not attempt to completely cover any facet of surveying.

The hope is that the Manual will be used as a reference by field survey parties, a planning document and reference by consultant firms employed by TDOT, and as a training tool for new employee orientation.

1.1 Organization

The following links illustrate the organization and reporting order of the survey function within the Design Division of the Department of Transportation. The Department is divided into four operational sections designated as Regions 1, 2, 3, and 4. The Regional Survey organization is the same statewide and reports directly to the Regional Director. The headquarters Survey and Design Office is divided into four sections, one responsible for Region 1, one for Region 2, one for Region 3, and one for Region 4. The Survey and Design Offices are part of the Design Division in the Bureau of Engineering.

Tennessee Department of Transportation:

https://www.tn.gov/content/dam/tn/tdot/documents/TDOT_OrgChart.pdf

Design Division:

<https://www.tn.gov/tdot/roadway-design.html>

1.2 Public Relations

1.2.1 General

Each employee is a representative of the Department of Transportation and is responsible for developing and maintaining public goodwill. The outdoor nature of surveying keeps personnel in the “public eye” much of the time. Work shall be accomplished efficiently and with a minimum of idle time. All direct contact with the public shall be pleasant, courteous, and businesslike. This includes answering general questions, listening to criticism (justified or not) and listening to suggestions.

1.2.2 Questions from the Public

All questions shall be referred to the Field Supervisor. The Field Supervisor shall refer the person asking the question to the Regional Survey Office. Since exact alignment is determined during the design phase, avoid conversations about possible route locations.

1.2.3 Property Owners

Dealing with property owners is a vital facet of public relations. The property owner will be directly affected by the survey and possible subsequent construction. The surveyor is usually the initial contact with the property owner and good relations developed by conscientious surveyors will carry over into all phases of the project.

As discussed in other sections of this manual, the first step of any survey involving private property shall be the personal contact of the property owner or tenant. At this meeting, the Field Supervisor shall request from the property owner information concerning the location of property lines, property corners, septic tanks, overflow fields and wells. In the case of commercial property, an inquiry shall be made as to the existence of underground storage tanks. The Property Owner Contact Form ([Appendix C.1.1](#)) shall be used for this purpose. A completed form for each tract shall be submitted as part of the completed survey. This procedure will also be applied to all railroad property. Any and all communication with railroad owners shall be through the railroad office.

1.2.4 Pre-Entry Contact

At least one week prior to commencing any survey activity on private property, contact letters shall be mailed to all property owners where entry is needed ([Appendix C.1.2](#)). Property owner’s names and addresses shall be obtained using the latest records available from the county Tax Assessor’s Office. To promote good relationships, a diligent effort shall be made to contact each property owner or tenant prior to entering the property. However, personal contact is preferable in order to explain why entry is required, the purpose of the survey, the activities involved, and to determine facts pertinent to the survey. The Property Owner Contact Form shall be used to document conversations with property owners. Property owner information and contact method shall be entered into the CADD file ([Section 4.1.2](#)).

1.2.5 Objection to Entry

When a property owner or tenant objects to entry, DO NOT ENTER! If the property owner voices objection after the survey has begun, leave immediately. The Regional Survey Office shall be contacted, and negotiations begun at that level. If entry cannot be gained, the Survey Coordinator shall be contacted. If efforts fail at that level, legal action can be taken.

1.3 Legal Aspects

1.3.1 Right to Enter Private Property

The Tennessee Code Annotated (Sections 29-16-121, 62-18-124) provides for entry upon private property for the purpose of locating and laying out any road to become a part of the state system of highways, subject only to a duty to compensate the property owner for actual damages to the property. The Tennessee Code Annotated (Section 54-5-107) further authorizes the employees of the Department of Transportation, while engaged in locating, laying out, or constructing any road to become a part of the state system of highways, to do so without interference. In the event of such interference, an injunction to prohibit this conduct may be obtained. Upon entering property, the property must be protected from damage to the fullest extent possible. For additional information, refer to [Section 1.2.4](#) and [Section 1.2.5](#).

1.3.2 Claims for Damage to Private Property

In the event a property owner feels he or she is due compensation for damage done to his or her property, he or she should seek restitution through the Division of Claims Administration, Treasury Department. The property owner is responsible for the contact. However, Field Supervisors shall cooperate fully in supplying information of their activities while on the property in question. The address of the State Claims Administration is:

Division of Claims Administration Treasury Department
9th Floor - Andrew Jackson Building Nashville, Tennessee 37243
Phone: (615) 741-2734

1.3.3 Citizen's Right to View Documents

The Department maintains an open records policy and any citizen has the right to observe and copy most documents that are relative to his inquiry. However, most documents are public property, and possession is not to be surrendered without specific approval from the director of the Design Division.

1.3.4 Right to Control Traffic During Survey

There is no specific law authorizing members of a survey party to control traffic. However, state personnel are legally empowered to survey “without interference.” All reasonable measures shall be used to preclude interference with vehicular movement, and lane closures shall not be considered until all other alternatives have been exhausted. Even without lane closures, recognize that anyone working in, adjacent to or near active travel lanes impose influence on motorist behaviors. Safe placement of vehicles, equipment and personnel shall comply with the MUTCD, TDOT policies and guidance. At no time will the performance of work be conducted at the expense of personal risk of exposure to vehicular traffic without proper controls. Likewise, there shall be no unnecessary exposure of the motorist to conditions that require maneuvers or decisions to traverse an active work area. Interference or even influence on vehicular movements (i.e., shoulder closures, work within rights-of-way) without providing clear and concise communication to the motorist will not be allowed. Provision of clear communication to motorists will be accomplished through use of temporary traffic control devices, including but not limited to signs, cones, message/arrow boards and vehicular lighting (not hazard lights) with these often conducted or set up by the survey party crew. In the event that full lane closures and more complex traffic control measures are necessary, they shall be provided by Regional / District Maintenance personnel through appropriate internal communication of requests, planning and scheduling with Regional / District Operations staff who have access to the required equipment and resources to perform this work.

To understand and make informed decisions regarding the type of temporary traffic control measures required for certain roadway types, activities and for general planning purposes, it is required that the TDOT survey supervisors and managers are certified in Flagging Operations and Basic Work Zone Traffic Control. Similarly, Flagging and basic Work Zone Training (Traffic Control Technician) courses are required for crew leaders of consultants/contractors, through ATSSA or similarly approved resource training courses.

In all cases, while conducting routine activities within rights-of-way (State or municipal-owned) or lane closures and complex setups, use of appropriate temporary traffic control measures shall be utilized according to the procedures outlined in the resources listed below: the current edition of the *Manual on Uniform Traffic Control Devices* (MUTCD), the layouts and information provided in the *Informational and Instructional Memorandum for Conducting Survey Activities* (or update included in this manual) and the current edition of the *Work Zone Field Manual for Maintenance Operations* (WZFM). These previously listed documents are available through the HQ or Regional Traffic Operations Division and HQ or Regional Occupational Health & Safety Division.

The documents are also available online, at the following websites and SharePoint locations:

MUTCD: <https://mutcd.fhwa.dot.gov/>

WZFM (TDOT): [Work Zone Safety and Equipment \(sharepoint.com\)](#)

WZFM (Consultants): https://www.tn.gov/content/dam/tn/tdot/occupational-health-and-safety/Work%20Zone%20Field%20Manual_2021.pdf

Survey Activities TTC Memo (TDOT): <https://www.tn.gov/tdot/roadway-design/survey-standards/survey-cadd-files.html>

- The **Safety Memo – Survey Activity TIC** can be found under the **Standard Survey CADD Files and Documents >> Others** heading on this site.

1.4 Safety

Survey personnel perform their work in many different hazardous environments including rugged terrain and high-speed traffic. The promotion of a safe atmosphere requires the acknowledgment, assessment, mitigation, and elimination of hazards. Each person must be attentive to potential hazards and adhere to safe practices, policies and guidance. Each individual shares responsibility in their safety. The Field Supervisor not only provides supervision and directs the activities of the party, but assures safe conditions exist and proper controls are utilized for the activity being performed. As previously discussed in [Section 1.3.4](#), traffic control deployment, management and retrieval are as important as the use of all Personal Protection Equipment (PPE), tools and resources in performance of the work activity. The [PPE Policy, TDOT 305-01](#), provides information and requirements for all TDOT employees and specific information with the activity matrix included in [TDOT Policy 305-01, Table A](#), to guide TDOT employees in making decisions for PPE, based on the activity being performed. Consultants can access Part 712.04 E within the [TDOT Standard Specifications for Road and Bridge Construction](#). PPE examples include, but are not limited to, a hard hat meeting ANSI Z89.1-Industrial Head Protection Type 1, Class C, a high-visibility, yellow-green ANSI/ISEA 107-2015 Class 3R vest, shirt, or jacket as their outermost garment and footwear equipped, at minimum, with a hard sole and closed toe. As with all TDOT vehicles, the use of seat belts by all parties in vehicles is mandatory.

Safety questions can be directed to the TDOT Headquarters Safety Division, 400 James K. Polk Building, Nashville Tennessee, or the Regional Safety Managers.

Chapter 2. Survey Control

The surveying guidelines described in the following chapters recommend methods and procedures needed to attain a desired survey accuracy standard. The guidelines in this section are based upon several sources of information, as well as current and past TDOT procedures.

With the continuous evolution of Global Positioning Systems and Surveying Technology, new guidelines will need to be developed and existing guidelines will be changed. The guidelines described in this section are not intended to discourage the development of new surveying procedures and techniques.

As a whole, TDOT will adhere to the Federal Geographic Data Committee's Geospatial Positioning Accuracy Standards, Parts 1-5 as the basis for all standards for surveying procedures. Consultants shall adhere to the standards as laid out in these chapters.

<https://www.fgdc.gov/standards/projects/accuracy>

2.1 Project Control (General)

2.1.1 Horizontal

All survey projects shall be tied to the Tennessee Geodetic Reference Network (TGRN) or Continuously Operating Reference Stations ([CORS network](#)). [Section 2.1.3](#) will provide a more detailed discussion of the TGRN.

Ties shall consist of intervisible monuments along the length of the project. Spacing will depend on the type of project, terrain, etc. and will be determined by the Regional Survey Manager (Determined by the Regional Survey Manager). If intervisible monuments cannot be placed throughout the entire project, another option is intervisible pairs of control points spaced along the project.

Semi-permanent monuments will be used (reinforcing bars with metal caps or better). Also, an adequate description and “to-reach” shall be prepared. A route description from a nearby landmark, a taped distance and azimuth to the witness post, and at least two other reference points should be shown. Points along an existing route should be tied to the log mile.

Coordinate values for the monuments will be “Tennessee State Plane Grid Coordinates”. These coordinates will be datum adjusted before being supplied to field crews for surveying and / or mapping. A more complete discussion of datum adjustment may be found in [Section 2.1.3](#).

All ties to the TGRN will be made utilizing GNSS techniques. All GNSS surveys will be according to the publication “Geospatial Positioning Accuracy Standards,” specifically parts 1 thru 4, distributed by the Federal Geographic Data Committee. **GNSS Surveys shall meet First Order (1:100000) accuracy standards as an absolute minimum.** One part in one million closure for GNSS control work is preferred.

Project control traverses will be required where GNSS coverage is not available (generally wooded areas). The traverse will commence and end at pairs of TGRN tied control points. Since these surveys originate and terminate at points with datum adjusted Tennessee State Plane Coordinates, all computed coordinates will be datum adjusted Tennessee State Plane Coordinates. No further datum adjustment is required.

Project control traverses shall meet Second Order Class II Standards (1:20000) or better, (Refer to [Section 2.2](#) and [Appendix C.7](#)).

After the raw field data for project control has been compiled, computed, and minimum standards met, traverses shall be adjusted using the least squares method or the compass/bowditch rule.

Each leg of the project control survey (between adjacent pairs of TGRN tie points) shall be considered and adjusted independently.

All TGRN tie points (control pairs) and project control traverse points shall be clearly shown and labeled in the planimetrics file ([Section 4.1.2](#)).

Coordinates will be listed with current notation plus the year of the upgrade in parentheses, immediately following. Therefore, reference to current coordinate values will be **NAD 83 (2011)** for geographic coordinates and **SPCS 83 (2011)** for state plane coordinates.

2.1.2 Vertical

GNSS methods may be used for vertical control for projects provided approved procedures are followed.

Please check with the TDOT Regional Survey Coordinator for a recommendation as to the appropriate geoid model to utilize. Unless directed otherwise, known third order or better North American Vertical Datum of 1988 (**NAVD 88**) benchmarks shall be occupied in the project control sessions and used for vertical ties and adjustment.

2.1.3 Survey Datums and the Tennessee Grid System

2.1.3.1 Datums

The North American Datum of 1983 (NAD 83 2011) has been adopted for reference of control for most TDOT projects and is set as the default in all ORD seed files (**TN83/2011F - NSRS11(NAD83/2011) Tennessee State Plane Zone, US Foot**). For any datum prior to 2011, use the **EPSG:2274 - NAD83 / Tennessee (ft US)** datum. The reference for vertical control, the Sea Level Datum of 1929 established by the USC & GS, has also been adjusted by NGS. This new North American Vertical Datum of 1988 (NAVD 88) has been adopted for reference of vertical control for all TDOT projects. Unless directed otherwise, **Geoid 18** shall be the default Geoid Model.

The horizontal and vertical datum used ([Section 2.1](#) and [Section 4.4](#)) shall be noted in the planimetrics file and on the check plot. Examples: “Coordinates are Datum Adjusted NAD 83 (2011) by the factor of 1.000XX”. The “2011” refers to the year of the most recent adjustment of coordinate values in Tennessee and “1.000XX” refers to the actual datum adjustment factor used for the project. And “All elevations are referenced to the NAVD 1988”. Datum adjustment factors will be accurate to at least five decimal places.

2.1.3.2 Vertical Datums

Vertical datum is mean sea level. A network of monuments has been established throughout the United States and a listing has been published by NGS. An assumed vertical reference will not be used unless authorized by the Regional Survey Supervisor.

2.1.3.3 Horizontal Datums

All route survey projects shall be tied to the TGRN or CORS network. This will allow all surveys to be correlated to a single reference framework. Point locations will be fixed and cannot be considered legally lost. Overlapping projects will be consistent and plane surveying will be possible over large areas without the introduction of significant error. Also, a uniform computational base will be established, and fewer errors will go undetected.

2.1.3.4 Tennessee Geodetic Reference Network (TGRN)

To provide for ties more easily and accurately to NAD 83, the TGRN has been developed. It is a highly accurate network of three-dimensional monuments designed for use with GNSS equipment. The TGRN was tied to and is consistent with NAD 83. The network monuments are evenly spaced throughout the state so that no project shall be more than 15 miles from a network station. The internal accuracy of 1:107 makes the network ideally suited for ties with highly accurate GNSS equipment. Network monument locations were also chosen with attention to visibility and accessibility desirable for GNSS equipment.

The TGRN has been surveyed to **Order B** geodetic accuracy standards as specified in the "Proposed Geometric Geodetic Survey Standards and Specifications for Geodetic Surveys Using GPS Relative Positioning Techniques," (Hothem 1986). The TGRN is tied to the North American Datum of 1983 (NAD/83) by connections to three (3) stations of the National Geodetic Survey (NGS) Eastern United States Strain Network. Internal accuracies of the network stations exceed 1:1,000,000. Coordinates are described as NAD 83 (2007). Azimuth points are located at twelve (12) of the TGRN stations and others may be added in the future. However, the TRGN is intended as a reference for GPS surveys, which require no azimuth marks, and their installation is of low priority.

Monuments at TGRN stations are brass caps in exposed bedrock outcroppings or driven steel rods encased in PVC pipe with access covers. Most stations have a fiberglass or conventional metal witness post nearby.

TDOT is responsible for maintenance of the TRGN and any pertinent information concerning potential or existing problems at monument sites will be appreciated. Any destruction of the monument or witness post, new or proposed development in the immediate area, changes in visibility around the mark, etc., should be reported to the respective T.D.O.T. Regional Survey Office Supervisor. Users should also be careful to ensure that access covers are tightly closed upon completion of a survey.

TGRN Data can be accessed in the TDOT Geodetic Control app:

<https://experience.arcgis.com/experience/a1059f996fd24f4aa543edc75759d4cc>

First you will need to turn off the default Project Control layer and turn on the TGRN layer in the sidebar (Figure 1).

FIGURE 1. TDOT GEODETIC CONTROL APP - TGRN LAYER

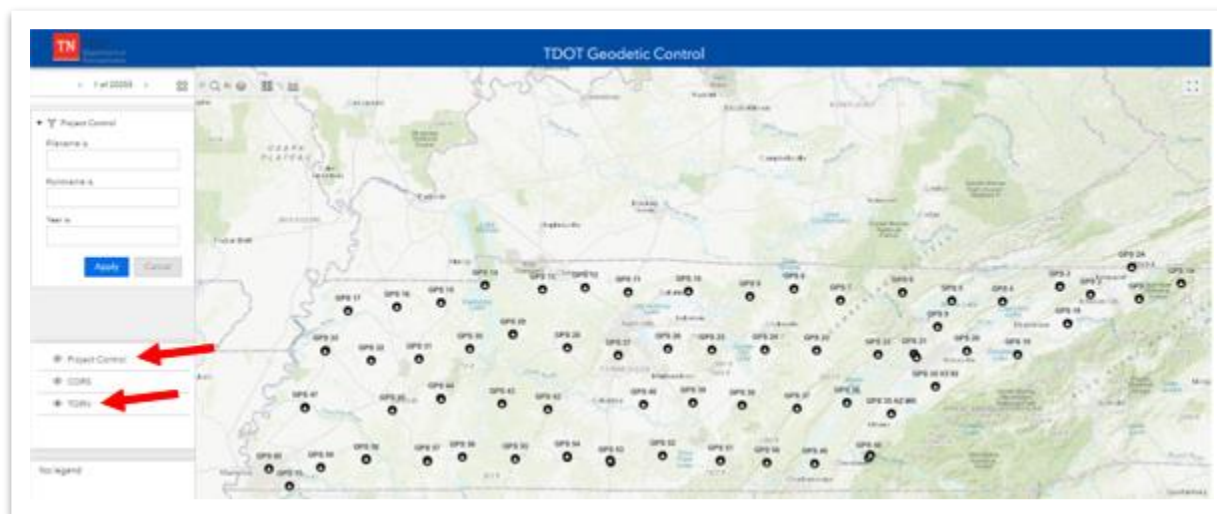

Select a TGRN point to get more info. Within the popup you can select "Data Sheet" to get the most up to date data from NGS's site.

Chapter 2. Survey Control

Here you can also view TDOT's CORS Network by turning on the CORS layer in the sidebar (Figure 2).

FIGURE 2. TDOT GEODETIC CONTROL APP - CORS LAYER

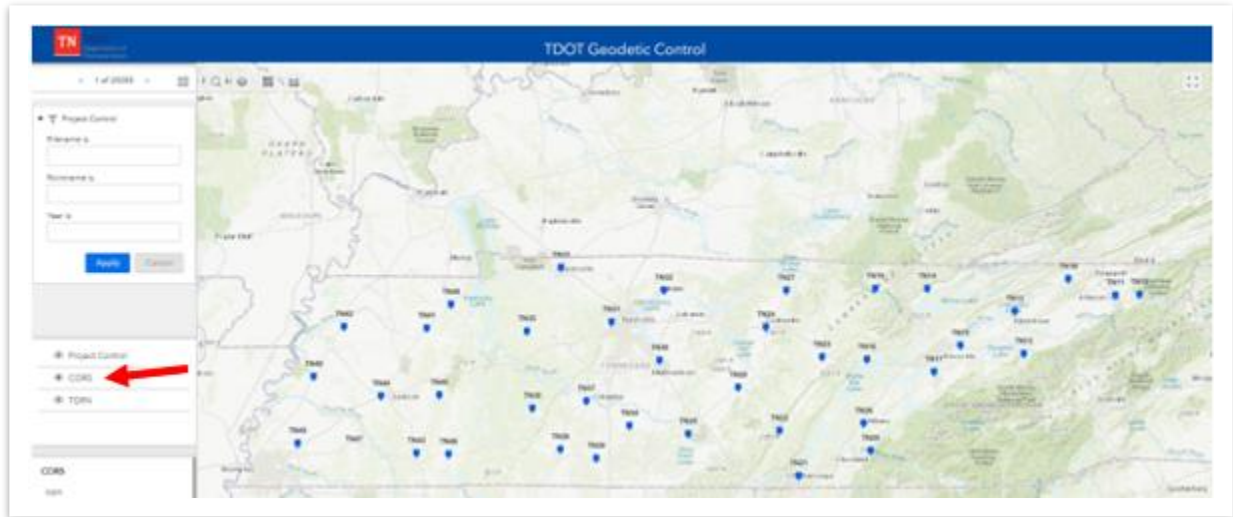

Select a CORS station to get more info. Within the popup you can select “Get Site Info” and it will redirect you to NGS’s site where you can download CORS data.

Additional information concerning the TGRN is available through the State Survey Coordinators Office or any Regional Survey Office.

2.1.3.5 Tennessee Grid System

The Tennessee Grid System is derived from the Lambert Conformal Conic Projection (Figure 3). The Lambert projection is used in approximately 31 states in the United States and is best suited for states with East-West elongation, such as Tennessee.

Conformal means that the configuration of the area projected is maintained. Conic implies that the projection is extended to the surface of a large cone, as shown in Figure 4. Assume that the cone intersects the spheroid (slightly flattened sphere) or the mean earth's surface along two lines known as standard parallels of latitude [B-C and D-E in Figure 4 (a)]. Parallels of latitude [F-G and H-I] are the limits of the projection. The apex of the cone of projection is point "A". Line J-K is the central meridian line. The central meridian for Tennessee is longitude 86°-00'. Figure 4 (b) shows a portion of the plane surface developed from the cone of projection. If the limits of the projection do not exceed 158 miles, the North-South distortions are one part in 10,000 or less. The scale, defined as the ratio of a length on the projection grid distance to a corresponding geodetic distance on the sphere's sea-level surface, varies in the North-South direction. The scale is exact along the parallels in an East-West direction.

FIGURE 3. TENNESSEE LAMBERT MAP PROJECTION

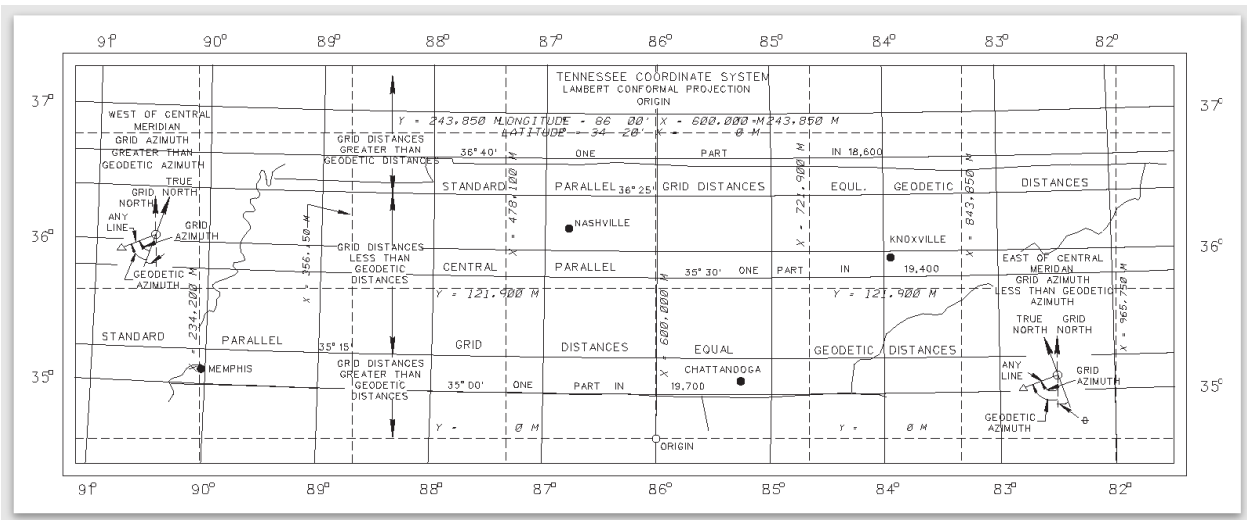
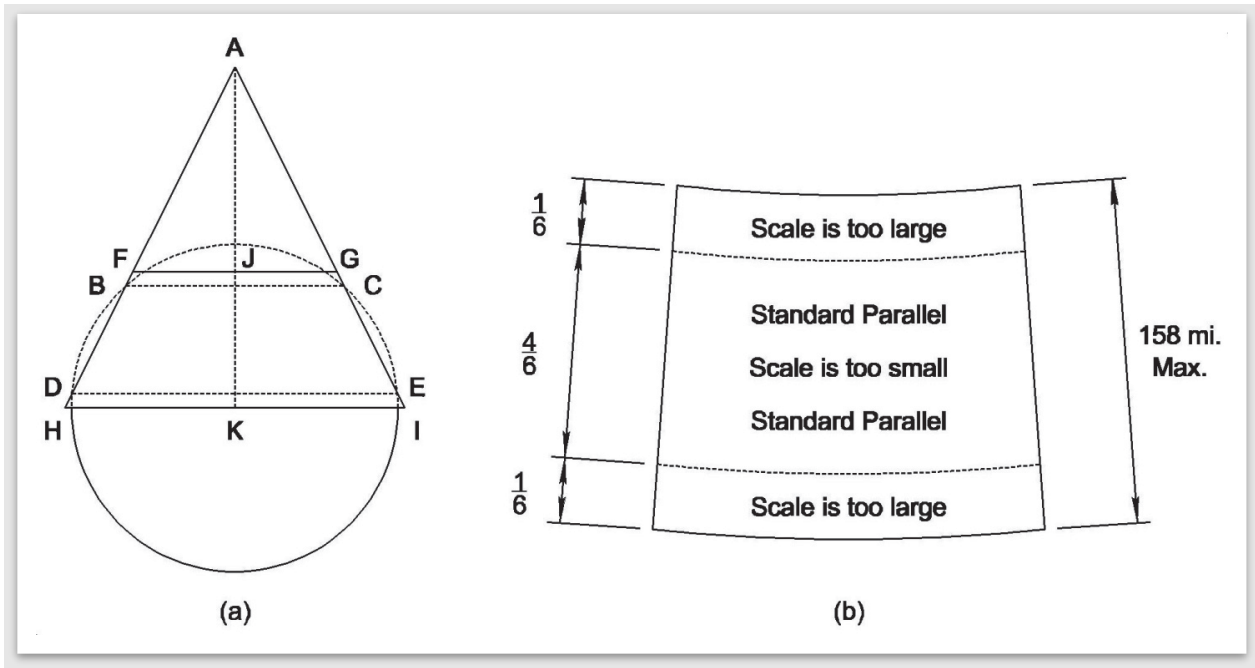

FIGURE 4. LAMBERT CONFORMAL MAP PROJECTION



[Appendix C.11](#) contains excerpts from NOAA Manual NOS NGS 5, "State Plane Coordinate System of 1983" by James E. Stem. The manual, distributed by the U.S. Department of Commerce, gives a more detailed look at SPCS and computations involved. Most surveying software on the market today provides for easy conversion of coordinates from one datum to another. Therefore, details of the computations are not included in the body of this manual.

All TDOT surveys that relate to the grid system shall be datum adjusted to raise or lower the plane of projection of the surveyed points to the earth's surface. This facilitates staking of centerline, R.O.W., and construction points. Procedures used by GNSS crews, when establishing project control, provide for this required datum adjustment. Each datum adjustment factor is project specific and is computed with the assistance of GNSS baseline processing software developed specifically for this purpose.

2.2 Accuracy and Errors

2.2.1 Accuracy and Precision

The accuracy of a field survey depends directly upon its precision. Accuracy is the degree of conformity with a standard or a measure of closeness to a true value. Precision is the degree of refinement in the performance of an operation or in the statement of a result. Accuracy relates to the quality of the result obtained when compared to a standard. Precision relates to the quality of the operation used to attain the result.

Surveys with high order accuracies could be attained (through luck) without high order precision, therefore making such accuracies meaningless. All measurements and results shall be quoted in terms that are commensurate with the precision used to attain the results. Similarly, all surveys must be performed with a precision which assures that the desired accuracy is attained.

Precision is indicated by the number of decimal places to which a computation is carried, and a result stated. Actual precision is governed by the accuracy of the source data and the number of significant figures, rather than by the number of decimal places.

2.2.2 Order of Accuracy

Table 1 gives the standards of accuracy for horizontal and vertical control. GNSS control parties shall maintain **First Order** as a minimum. All other survey parties shall maintain Second Order - Class II.

TABLE 1. POSITIONAL ACCURACY

TDOT Order (See Note 1, 2 and 5)	STANDARDS			PROCEDURES				TYPICAL APPLICATIONS	
	Relative Standards	Positional Accuracy		Monument Spacing		Survey Methods		Horizontal	Vertical
		Horizontal 95% Confidence Circle	Vertical 95% Confidence Circle	Horizontal (Not to Exceed)	Horizontal Spacing for Vertical Accuracy (Average)	Horizontal	Vertical		
Sub Centimeter (0.026 sft) Network Accuracy	Supersedes Traditional Order B or Better GNSS Surveys	0.008 m or less (0.026 sft) Network Accuracy	0.008 m or less (0.026 sft) Vertical Network Accuracy Equivalent to First Order Class I Proportional Standards (See NGS Standards)	20 Miles	1 Mile	GNSS Static	Use NGS First Order Standards	HARN (High Accuracy Reference Network) and CORS Monuments Basis of Coordinates and Bearings	Used in lieu of FGDC First Order, Class I Vertical Network Standards (Not Required for TDOT Projects)
One Centimeter (0.03 sft) Network Accuracy	Supersedes First Order GNSS Surveys; Used in lieu of Second Order (Class I) Vertical Surveys	0.010 m or less (0.03 sft) Network Accuracy	Equivalent to Second Order Class II Proportional Standards (See Table 2)	2 Miles	1 Mile	GNSS Static Fast Static (See Note 3)	Differential Digital Levels with Invar Bar Code Rod	Primary Project Control and Wing Points Basis of Coordinates / Bearings (See Note 4)	Geodetic Control – Used in lieu of FGDC Second Order Class I Proportional Vertical Survey
Two Centimeter (0.07 sft) Network Accuracy	Used in lieu of Traditional Second Order (Class II) GNSS Surveys	0.020 m or less (0.07 sft) Network Accuracy	Equivalent to Second Order Class II Proportional Standards (See Table 2)	2,500 ft	4 Mile	GNSS Static Fast Static, RTK Total Station System Traverse	GNSS Static / Fast Static Differential, RTK or Optical Levels with Standard Rod	Secondary Project Control (See Note 4)	Used in lieu of FGDC Second Order Class II Proportional Vertical Survey

Chapter 2. Survey Control

TDOT Order (See Note 1, 2 and 5)	STANDARDS			PROCEDURES				TYPICAL APPLICATIONS	
	Relative	Positional Accuracy		Monument Spacing		Survey Methods		Horizontal	Vertical
	Standards	Horizontal 95% Confidence Circle	Vertical 95% Confidence Circle	Horizontal (Not to Exceed)	Horizontal Spacing for Vertical Accuracy (Average)	Horizontal	Vertical		
0.07 (Two Centimeter) Local Accuracy	Substitute for Traditional Third Order Horizontal and Vertical Surveys	0.07 sft or less (0.02 m) Local Accuracy	Equivalent to Third Order Proportional Standards (See Table 2)	500 ft or As Required	4,400 ft (10 Turns)	GNSS Static/Fast Static Real Time Kinematic Total Station System Traverse	Differential Digital Optical Levels with Standard Rod Total Station System Trig Leveling	Cadastral Surveys and Supplemental Control Traverse between Secondary Project Control	Used in lieu of Third Order Proportional Vertical Surveys for GNSS Network Surveys
0.2 sft (Five Centimeter) Local Accuracy	General Order Survey or Mapping Grade	0.2 sft or less (0.05 m) Local Accuracy	N/A	N/A	N/A	GNSS Real Time Kinematic Total Station Radial within 500 ft	GNSS Real Time Kinematic Total Station Radial within 500 ft Optical Level or Better	Topographical features (signs, water valves, etc.), High-Risk Utilities, existing culverts	Natural Ground elevations, Utility As-builts
0.3 sft (Ten Centimeter) Local Accuracy	General Order Survey or Mapping Grade	.03 sft or less (0.1 m) Local Accuracy	N/A	N/A	N/A	As Needed	As Needed	Utility As-builts and 2-D Locations	Utility As-builts
3 sft (One Meter) Resource Accuracy	N/A	3 sft (1m)	N/A	N/A	N/A	GNSS Receiver with correctional signs	N/A	Locating features for GIS database, such as signs, trees, or drainage pipes	N/A
33 sft (Ten Meter) Resource Accuracy	N/A	33 sft (10 m)	N/A	N/A	N/A	GNSS Receiver without correctional signal	N/A	Locating sites of interest, such as environmental sensitive areas or accident scenes	N/A

NOTES:

For the preferred method for obtaining vertical control accuracies see Table 2 (on the next page).

1. Network accuracy is described as the accuracy of a control station that represents the uncertainty of its coordinates with respect to the geodetic datum at the 95-percent confidence level.
2. Local accuracy is the relative accuracy between local control points and represents the uncertainty of its coordinates relative to other directly connected adjacent control points at the 95-percent confidence level.
3. Static GNSS Methods required if baseline lengths are greater than 12 miles.
4. 1-cm, Network Accuracy is the preferred accuracy for Horizontal Project Control Surveys directly tied to NGS CORS and using the latest NSRS Datum Tag. 2-cm Network Accuracy is the minimum accuracy for Project Control Surveys.
5. The TDOT Positional and Proportional Orders of Accuracy are based on the standards set by the Federal Geographic Data Committee's Geospatial Positioning Accuracy Standards, Specifically FGDC-STD-007.1-1998 (Part 1: Reporting Methodology), FGDC-STD-007.2-1998 (Part 2: Standards for Geodetic Networks), and FGDC-STD-007.4-2002 (Part 4: Architecture, Engineering, Construction, and Facilities Management).

TABLE 2. PROPORTIONAL ACCURACY

TDOT Proportional Orders (See Note 3)	STANDARDS			MONUMENT SPACING AND SURVEY METHODS (NOTE 1)			APPLICATION – TYPICAL SURVEYS	
	Classical		Positional	Monument Spacing (Typical)	Typical Survey Method		Horizontal	Vertical
	Horizontal	Vertical			Horizontal	Vertical		
	Note 1	Note 1						
Second-Order Class I	1:50,000	$e=0.025\sqrt{M}$ (Note 2)	Equivalent to 1 cm Horizontal and Vertical Network Accuracy	TSS 2300 ft Min Vertical 1 Mile Average	Total Station Trig-Network	Digital Bar Code Level with Invar Staff	Precise Control for structures and tunnels (Not required for typical projects)	Geodetic Control (Rare)
Second-Order Class II	1:20,000	$e=0.035\sqrt{M}$	Equivalent to 2 cm Horizontal Network Accuracy Only	TSS 930 ft Min Vertical 1.8 Mile Average	Total Station Trig-Network	Digital Bar Code or 3-Wire Optical Leveling	Project Control – Horizontal Interchange and Major Structure Control	Preferred Project Control Major Structure Points (Staked)
Third-Order Class I	1:10,000	$e=0.050\sqrt{M}$	Equivalent to 0.07 sft (2 cm) Horizontal and Vertical Local Accuracy	As Required	Total Station Network or Traverse	Digital Bar Code or Optical Leveling Total Station-Trig Leveling	Supplemental Control Construction Control Photo Control – Horiz. Right-of-Way Surveys Construction Surveys Base Mapping Surveys STLS and MTLs Control Points	Project Control Vertical Supplemental Control Construction Control Photo Control – Horiz. Right-of-Way Surveys Construction Surveys Base Mapping Surveys STLS and MTLs Control Points
Third-Order Class II	1:5,000							
General	1:1,000	0.1 per 100 feet	Used in lieu of 0.2 ft Local Accuracy	N/A	Total Station Steel or Nylon Tape	Total Station-Trig Leveling, Single Wire, Direct Elevation Rod, Hand Level	Topographic Surveys (Data Points), Supplemental Design Data Surveys, Construction Surveys (Staked Points), Right of Way Flagging, Asset Inventory Surveys, Archeological Surveys, Environmental Surveys, Historical Preservation Surveys, Monitoring Surveys, Earthwork Surveys such as stockpiles, and borrow pits	

NOTES:

1. Proportional or relative accuracy is described as the ratio between the overall length of a traverse and the misclosure of the final course.
2. M = Distance of level run, in Miles.
3. The TDOT Positional and Proportional Orders of Accuracy are based on the standards set by the Federal Geographic Data Committee's Geospatial Positioning Accuracy Standards, Specifically FGDC-STD-007.1-1998 (Part 1: Reporting Methodology), FGDC-STD-007.2-1998 (Part 2: Standards for Geodetic Networks), and FGDC-STD-007.4-2002 (Part 4: Architecture, Engineering, Construction, and Facilities Management).

2.3 Project Control (GNSS Procedures)

2.3.1 Pre-Planning

Use available mapping and planning reports to locate the project on a map and read the approximate latitude and longitude of the project.

Based upon the map, the surveyor can get a rough idea of the number of points that will be required, and how long it might take to establish control for the project. The map can be used to estimate point placement, manpower needs, and potential problems with satellite blockage. The surveyor can also get an idea of how much of the project will be accessible by vehicle and where walking to the point will be required.

2.3.2 Reconnaissance

Contact any property owners in accordance with requirements in Chapter 1.

Determine control point placement as follows:

- Place points in the clear, away from trees, buildings, and potential multi-path structures. Maximum obstruction angle shall be 20°.
- Nominal control point spacing of 500 ft to 1000 ft.
- Points should be intervisible when possible. Exceptions will be large, wooded areas ([Appendix C.13.2](#)). The surveyor would simply skip this area and start placing points again on the other side.
- Place points close to the projected centerline so that they will be of the most use to the surveyors (i.e., on hilltops). However, some thought should also be given to placing these points so that at least some of them will survive construction.
- Document blockage problems on the site log ([Section 2.3.3.1](#)). If there are blockage problems, place the control point to the south of the blockage since the satellite path never crosses due north.

2.3.3 Receiver Setup Procedures

2.3.3.1 Site Log

The **Site Log** for GNSS occupations can be found under the **Standard Survey CADD Files and Documents >> Project Control** heading on this site:

<https://www.tn.gov/content/tn/tdot/roadway-design/survey-standards/survey-cadd-files.html>

2.3.3.2 Static Method

- Improper instrument setup (human error) accounts for the most and largest errors when performing GNSS surveys. Therefore, care must be exercised during setup.
- Use extra care to assure correct set up on the point.

- Make sure to properly focus the plummet and crosshairs. Check to assure the instrument is on the point during the session and before breaking down the tripod to move. Triple checking the setup will greatly reduce the human error during the session.
- Check and record the height of instrument (HI) reading on the site log when setting up. Check the HI again during the recording session and once more before breaking down the instrument to move. This again aids in reducing human error during the session.
- Set the tripod so that the receiver is at or above head height.
- Set the tripod legs wide enough to prevent the tripod from being blown over. If windy or near a highway, add weight to the leg bases in the form of sandbags or blocks.
- Press the tripod feet firmly into the ground.
- If sent to retrieve another receiver, check the setup before breaking it down.
- Do not be afraid to report possible errors to the party chief. It is better to reoccupy the point while the survey crew is still in the field, than to try and determine what went wrong back in the office.

2.3.3.3 RTK Method with a Base Station

- TDOT control points should be located on the job and the base should be set up on one of the control points (preferably one that has the best visibility of the sky and is located in a relatively safe place).
- The surveyor should try to prevent the base from being disturbed or being an obstruction to traffic.
- The surveyor should set the base on a fixed height tripod.

2.3.4 Observation Methods

GNSS Surveying is an evolving technology. As GNSS hardware and processing software are improved, new specifications will be developed, and existing specifications will be changed. The specifications described in this section are not intended to discourage the development of new GNSS procedures and techniques.

Note: Newly developed GNSS procedures and techniques, which do not conform to the specifications in this chapter, may be employed for production surveys, if approved by the District/Region Survey Manager. New developed procedures shall be submitted to the District/Region Survey Manager for distribution and peer review by other districts.

The three methods of observations are discussed below:

- Static Traverse
- Static Wing Point
- RTK

2.3.4.1 Static Methods

There are two basic methods used by TDOT using static GNSS procedures to bring control into a project from the TGRN reference points. For this discussion, we will refer to them as the Traverse Method and the Wing Point Method. Table 3 shows advantages and disadvantages of each method.

A diagram of both methods is shown in [Appendix C.13](#).

TABLE 3. SUMMARY OF STATIC GNSS METHODS

Method	Advantages	Disadvantages
Traverse	Uses similar leapfrog methodology as the conventional traverse. Is more efficient for projects with five or fewer control points.	Due to inherent possible errors in GNSS baselines, error can accumulate rapidly. Requires high degree of coordination between survey crew. Requires higher degree of sophistication from all crew members.
Wing Point	Baselines are longer, minimizing error. Points are measured from two base points giving a check. Wing points are likely to survive construction for later use. Less coordination is required between receiver operators. Base stations require little supervision for inexperienced operators. A true network is formed, giving stronger checks and adjustments. Wing points can be existing NGS benchmarks giving a vertical check on the network.	Time and effort are required to locate and set the wing points. Wing points are only useful for GNSS work because they have no Azimuth points.

2.3.5 Traverse Method

- Use this method if the project requires five (5) points or less, or if terrain conditions are non-conducive to the Wing Point Method ([Appendix C.13.1](#)).
- Reconnoiter the project and set pairs of points at approximate half mile intervals or additional points as needed.
- Choose a minimum of **two** TGRN points or CORS stations for tie points. **Never tie back to the same point.**
- On the first session, when using the TGRN, occupy TGRN A, TGRN B, and the first and last points on the project. Occupy these points for three (3) hours minimum using a 5-second epoch rate.

- After the long line observations are complete, change the receivers to a 1-second epoch rate for the remaining short lines.
- Short lines (lines less than 20 km (12 mi.) should be observed for 5 minutes plus 1 minute per km of baseline length. A minimum of 20 minutes of data is recommended on all lines, to allow for clipping bad segments of data. This allows for flexibility in computations during post processing when problems are discovered.

2.3.6 Wing Point Method

- This is the preferred method for all projects because of the greater accuracy that can be obtained ([Appendix C.13.2](#)).
- Set the wing points near the midpoint of the project, approximately 2 km (1 mi.) to 5 km (3 mi.) left and right of the proposed centerline. The maximum length of any measured line, from the wing points to the project control points, should be less than 10 km (6 mi.). Two or more pairs of wing points may be needed to accomplish this. Place wing points in the clear, away from trees, buildings, and potential multi-path structures.
- Reconnoiter the project and set pairs of points at approximate half mile intervals or additional points as needed.
- Choose a minimum of **two** TGRN points or CORS stations for tie points. **Never tie back to the same point.**
- In the first session, when using the TGRN, occupy TGRN A, TGRN B, and the two wing points. Occupy these points for three (3) hours minimum using a 5-second epoch rate. If there are more than two wing points on the project, perform the above-mentioned procedure for each pair of wing points.
- On subsequent missions, set base stations on the wing points and two rovers on the project. The base units will run continuously. The rovers will collect a minimum of 20 minutes of data for each of the project points and any image control points. It is advised that each rover have a list of points that he will occupy rather than just going to whichever point is next. This will eliminate duplicate or omitted points.

Note: Modified Wing Point Method for small two-point projects – Often, on a two-point project (bridge or intersection) the surveyor will have severe blockage on the site which makes collecting 3 hours of data very difficult. Using a modified wing point method, go up and down the road from the project a mile or two and chose a location with no blockages. Set one point up the road and one down the road from the actual project site. Occupy TGRN A, TGRN B, and these two modified wing points for a minimum of three (3) hours using a 5-second epoch rate ([Appendix C.13.3](#)). Then use 1-second epoch data collection on a short line from the modified wing points into the project and choose the best 20 min of data. Table 4 (on the next page) discusses possible problems and solutions.

TABLE 4. GNSS FIELD PROBLEMS AND REMEDIES

Problem	Remedy
PDOP goes above 6.0	Note the time in site log. Restart time count.
Thunderstorm or other atmospheric event	Note time and azimuth in site log.
Receiver is disturbed	Notify party chief. Restart point observation.
Forgot to begin recording	Notify party chief. Restart point observation.

2.3.7 RTK Method

- Set up the base on a known TDOT control point.
- Make sure the base is recording static data at 1-second epoch data. In the event that additional post-processing is needed, this data will be available for use.
- Establish the communication between the base and rover.
- Locate and record an observation of a known TDOT control point with the rover as a check that assures the scale factor and project settings are correct in the controller. Record observation as feature code XCK.
- If the point’s calculated coordinates are within acceptable tolerances as per project requirements (Table 5 on the next page), then survey work may ensue. If not, then steps should be taken to determine this error. This is a good indicator that a setting is incorrect. If the check point position is off vertically, then perhaps the wrong Geoid Model was selected for this job. If it is off horizontally, then perhaps an incorrect Scale factor / Datum Adjustment factor was used.
- Record this check in the file by taking a shot on the control point (number and coded correctly) and store it as an observation to the raw file for later reference. Do not overwrite the control point in the data collector. If the check point is coded and numbered correctly, a screen showing that this point already exists will require a response. The surveyor has 3 options: overwrite, use new number, or store in raw data. The surveyor should store in raw data only. This verifies the coordinates and can be reviewed later but does not create or overwrite the control. It is recommended to do this when first starting and before ending a session.
- The surveyor should periodically perform this control check during the survey session.
- Once the setup procedure has been completed and the tolerances are in check, the surveyor may proceed to collect data using the rover.
- Assure that the rover is plumb when collecting data.
- Always monitor satellite coverage to assure the accuracy has not decreased due to being near an obstruction.

- The procedure described above shall be repeated when using the TDOT GNSS Reference Network; however, the surveyor will connect to the network and will not use a portable base. Once a connection has been established to the TDOT GNSS Reference Network, the surveyor will perform checks on known TDOT control markers as described in this section before beginning the survey.

TABLE 5. GNSS NETWORK DESIGN SPECIFICATIONS

Level of Accuracy	CM (0.03 FT)	2 CM (0.066 FT)
Minimum Number of Closest Direct CORS Ties	1	0
Minimum Number of Total NGS Monuments	3	2 (See Note 1)
Minimum Number of Horizontal Station Ties	3	2
Minimum Number of Vertical Ties (2 nd Order or Better)	4	2
Minimum Number of Occupations per Station (See Note 2)	2	2
Minimum Number of Repeat BL's (% of all BL's)	30%	20%
Time Offset Between Observations / Occupations (See Note 2)	± 2hrs	± 1 hr
Minimum Satellite Elevation Mask	13 Degrees	13 Degrees
Minimum Number of Quadrants for Horizontal Station Ties	3	2
Minimum Number of Quadrants for Vertical Station Ties	4	2
Type of Ephemeris Required	Rapid or Precise	Broadcast or better

NOTES:

- These ties should be at least indirect ties to NSRS stations.
- To qualify for a new occupation, the observer must remove the GPS receiver at the station and a completely new setup over the station must take place.

2.3.8 Post-Processing Static Data

- Check the field data as it is inserted into the post-processing software. Be sure to check the HI, antenna offset, and point names. Be sure that control point names are always identical, or two different points which cannot be combined will be shown.
- Always check the log file for calculated lines for the items indicated in the site log ([Section 2.3.3.1](#)).
- Always check the log file for the network adjustment for the items listed in the site log ([Section 2.3.3.1](#)).
- When performing the network adjustment, be sure to fix benchmarks in height only. This is ellipsoid height not orthometric height.
- After network adjustment, process the final geographic coordinates to compute state plane coordinates and orthometric heights. The geoid model published by the National Geodetic Survey is the only approved model for computing orthometric heights. TN Lambert map projection information is available in [Section 2.1.3.5](#).
- Process the state plane coordinates through GNSS baseline processing software to compute an average datum adjustment factor for the project. This factor will be applied to all project control points to compute final published coordinates. (A sample project control report can be accessed on the [TDOT site](#) under the **Project Control** heading.)

Every TDOT Project Control submittal is required to include the following: a Project Control Report, a Site Log for each point, a close up photo of each point, an aerial map of the project control layout, a Project Control Format csv, and a Network Adjustment Report. A template for these documents can be found under the **Standard Survey CADD Files and Documents >> Project Control** heading on this site:

<https://www.tn.gov/content/tn/tdot/roadway-design/survey-standards/survey-cadd-files.html>

2.3.9 TDOT Control Point Database Use

TDOT's project control data can be accessed on the **TDOT Geodetic Control** app: <https://experience.arcgis.com/experience/a1059f996fd24f4aa543edc75759d4cc>

By default, the Project Control layer is turned on. Select a control point to view a popup of its location data. You can filter out the project control by Filename, Pointname or Year. Once you have filtered the control points, you can export its data as a csv by selecting the 4 dots above the filter (Figure 5).

FIGURE 5. TDOT GEODETTIC CONTROL APP - EXPORT OPTION

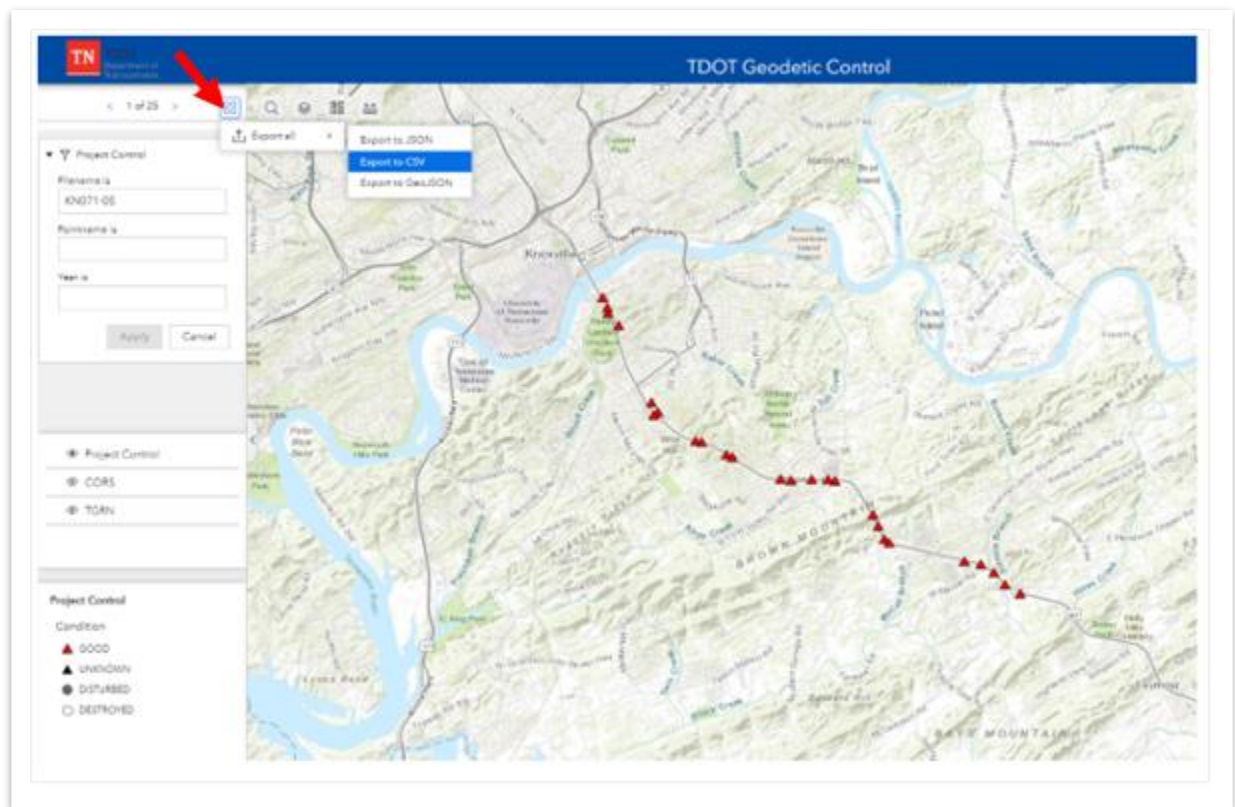

This database is also accessible via tablet and mobile for use in the field.

2.4 Aerial Survey Control

2.4.1 Traverse / GNSS Point Annotation

Annotate at coordinates and label with point name. Coordinates and elevation to be placed in aerial control point table.

2.5 Ground Control Preparation

2.5.1 Pre-Flight Targeting

When a project is to be mapped photogrammetrically, targets shall be placed on the ground at predetermined strategic points, marked with a reinforcing bar or other suitable metallic material and driven flush with the ground.

All known and recovered horizontal and vertical control monuments that exist inside the band of mapping shall be targeted. These monuments shall have been generated by an accepted surveying agency, preferably National Geodetic Survey (NGS) or TDOT.

In most instances a pre-flight targeting diagram can be furnished by the Aerial Surveys Division that considers the scale, model gain and side-lap geometry of the exposed format. Target placement on the ground shall follow the diagram as close as feasibly possible.

Targets used on TDOT projects are constructed of materials that have high visibility and contrast to the surrounding environmental condition. Target to be shaped to form a right angle with the point of observation being the inside corner of the target. Suitable targets could also include iron crosses, existing paint striping (e.g., parking strips, stop bars) or other easily photo identifiable features. On pavement, targets may be painted ([Appendix C.9.1](#)).

The size of the targets varies with the resolution of the imagery ([Appendix C.9.1](#)). After the project has been flown the target material shall be removed but the reinforcing bar or other reference material shall remain.

2.5.2 Horizontal Control

Project control monuments, in addition to and between Tennessee Geodetic Reference Network (TGRN) tie monuments ([Section 2.1.1](#)), shall be established along the mapping band as close as possible to the proposed centerline. These points are to be used for positioning horizontal image control and for projecting the proposed alignment. This monumentation for project control shall be semi-permanent, usually reinforcing bars with a stamped disk. An adequate description and “to-reach” shall then be written and retained for future needs. These monuments shall be in place before each project image flight. They can be pre-flight targeted and will substantially strengthen the horizontal and vertical image control survey.

The coordinate values of these monuments will be datum adjusted Tennessee State Plane Coordinates. Since TGRN tie monuments (with datum adjusted coordinates) are used for the origin and terminus of each leg of the project control traverse, no further datum adjustment is necessary.

The position of these monuments will be established by either total station traverse or Global Navigation Satellite System (GNSS) methods.

All observations shall be performed with equipment whose specifications meet Federal Geodetic Control Committee (FGCC) standards for geodetic surveys.

All project control surveys shall originate and terminate at TGRN tie monuments ([Section 2.1](#) and [Section 2.3](#)).

All project control surveys for photogrammetry shall meet Second (2nd) Order Class II Standards, per the scale of the map.

After raw field data has been compiled, computed and minimum standards met, project control traverses between adjacent pairs of TGRN or CORS network tie points shall be adjusted to those points by either least squares adjustment or compass rule adjustment methods.

Each leg of the project control survey (between adjacent pairs of TGRN or CORS network tie points) shall be considered and adjusted independently.

When aerial images have been obtained, picture points are then selected. Often, these are the targets that were in place when the exposures were made. Picture points are chosen to form a geometric pattern suitable for orienting, leveling and scaling, and to rectify the aerial image. When the targets are not in place, natural images must be carefully selected instead. Natural images can be fence posts, parking stripes, etc. The horizontal picture points are enclosed by triangles on the front and back of the image. The precise picture point is designated by a line pointer to the exact spot observed during the survey. An exact duplicate of each image shall be kept on file in the Regional Survey Office or the Consultant Firm's office to facilitate field checking for errors.

After picture points are chosen for the horizontal scheme, they are positioned by supplemental survey ties from the main scheme control network. These points shall be surveyed with Global Navigation Satellite System (GNSS), or Total Station standard procedures as directed by the Regional Survey Manager.

2.5.3 Vertical Control

Vertical survey control is as important to photogrammetric surveys as horizontal control. All known and acceptable Benchmarks, preferably NGS, TDOT, or Tennessee Valley Authority (TVA), which appears in the band of imagery shall be pre-flight targeted.

If there are too few known Benchmarks appearing on the images to satisfy the vertical image control geometry, Benchmarks shall be established along the proposed alignment. The Benchmarks shall be horizontal control monuments as well as vertical control monuments. These Benchmarks can be used throughout the project survey and construction and shall be adequately described and referenced for future use. All vertical image control points shall originate and terminate on or be looped back to Benchmarks that have been established to Third (3rd) Order FGCC criteria (Refer to [Appendix C.7.2](#) and [Section 2.2](#) for additional information on accuracy).

Vertical control instruments shall meet specifications required by the FGCC for Third Order accuracy.

In some instances, vertical image control may be established by trigonometric leveling with Total Station procedures. GNSS procedures may be allowed at the discretion of the Regional Survey Manager.

Vertical control points are marked on the front and back of selected images with a circle. Natural images for vertical image control can be corners of sidewalks, intersections of streets and roads, fence corners, etc. Vertical points shall be in a fairly level area and precisely designated and described on the back of the image. Vertical image points shall be designated with “V” as V-1, V-9, etc. The precise picture point is designated by a line pointer to the exact spot that was observed during the survey. If a point is both a horizontal and vertical control, it shall be designated HV.

Chapter 3. Aerial Surveys and Mapping

These guidelines shall be used as the standard for all computer-aided mapping produced by and for the Survey Office in the Design Division of the Tennessee Department of Transportation. Mapping submissions shall be in accordance with this manual and/or modifications contained in the consultant's contract or as prescribed by the Aerial Survey Manager.

3.1 Correspondence

All correspondence for support should be addressed to:

Tennessee Department of Transportation Office of Aerial Surveys
521 Olen Taylor Drive Nashville, TN 37217-2512

3.2 Standard Parameters

In order to establish standard parameters by which maps are to be created, the following guidelines have been established:

- The accuracy of a design file will be in direct correlation with the working units and the state plane coordinate system. This provides direct correlation of mapping and design data to the field control points.
- Standard level, color, style, and weight assignments of elements are assigned according to the type of map or sheet being generated. The user is referred to the CADD Guidelines published by the Design Division for these standards as well as other CADD standards such as font and cell files at the following website: <https://www.tn.gov/content/tn/tdot/roadway-design/design-standards/design-cadd-files.html#aerialsurvey4>

The user shall refer to the CADD Guidelines for the following standards:

- File extensions to be used
- Line styles to be used
- Color tables to be used
- Font files and font sizes to be used
- Seed files to be used
- The standard cell libraries are STDS_TRUE.cel and STDS_NON-TRUE.cel. Cells shall be scaled inversely proportional for mapping scales (i.e., AS=50 for 1"=50'; AS=100 for 1"=100'; and AS=200 for 1"=200'). The weight shown in the level structure is the weight at which the cell is drawn.

- Map features shall be digitized in a point-to-point mode. Standard mapping width is as follows:
 - 1"= 50' scale – 750' each side of proposed centerline
 - 1"= 100' scale – 1,500' each side of proposed centerline
 - 1"= 200' scale – 3,000' each side of proposed centerline

3.3 Aerial Mission

In order to establish standard parameters by which aerial imagery is to be obtained, the following parameters have been established:

- Aerial Imagery shall be undertaken only when well-defined images can be obtained. Imagery shall not be attempted when the ground is obscured by haze, smoke or dust, snow or ice, or when cloud or cloud shadows will occur on more than five percent of the area of any one image. Imagery shall not contain shadows caused by topographic relief and sun angle except when these shadows fall on a portion of the image not in the area of interest, which will not prevent the use of the remainder of the image for image interpretation, measuring and mapping. Imagery will not be undertaken when the sun angle is less than thirty degrees above the horizon. Super-wide angle, convergent or low oblique imagery will not be acceptable.
- Overlap on all imagery in the direction of the line of flight shall be sixty percent, unless otherwise specified, and overlap in the direction of the line of flight of more than sixty-five percent or less than fifty-five percent shall be cause for rejection of the imagery. In the case where parallel flights are necessary, the side lap of flights shall be thirty percent or more and any side lap less than fifteen percent shall be cause for rejection of the imagery.
- Tip and tilt of the imagery shall be kept to an absolute minimum. Tip and tilt in any case shall not exceed four degrees. Tip and tilt in excess of four degrees shall be cause for rejection of the imagery.
- Crab of the imagery in excess of three degrees is undesirable and crab in excess of five degrees in two or more of the images shall be cause for rejection of the imagery.

The required ground sample distance for imagery to be used for digital photogrammetric compilation is listed in Table 6.

TABLE 6. REQUIRED GROUND SAMPLE DISTANCE

Required Ground Sample Distance
Airplane – Digital
Extreme Detail (Old 1" = 50' scale mapping)
1.667 inch pixel size or GSD of 0.14'
Design Mapping Detail (Old 1" = 50' scale mapping)
3 inch pixel size or GSD of 0.25'
Planning Detail (Old 1" = 100' scale mapping)
6 inch pixel size or GSD of 0.41'
Wide Area Planning Detail (Old 1 = 200' scale mapping)
12 inch pixel size or GSD of 0.82'

The aerial camera to be used in imagery, unless otherwise specified, will be a large format aerial digital sensor such as a Vexcel UltraCAM or DMCII/III, or any equally precise camera. The camera must feature a resolution across the flight path of no less than 14,000 pixels, and a resolution along the flight path of no less than 11,000 pixels. All cameras must be calibrated within a three-year period prior to the beginning of the project work order. If it is desired to use a camera or resolution different than above, it will be required that special permission be obtained in writing from the Office of Aerial Surveys. In order to obtain permission to use a camera other than those listed above, it will be required that the complete specifications, including a current calibration report of the camera be submitted to the Photogrammetry Supervisor at the Office of Aerial Surveys.

3.4 Image Products

After completion of the aerial mission, the CONSULTANT shall furnish the following to the Office of Aerial Surveys for final custody in the Aerial Surveys Office:

- All images collected as part of the flight, in both RGB color and in near-infrared (NIR) false-color imagery, unless otherwise specified by the Office of Aerial Surveys. Image color bit depth to be no greater than 8 bits per channel. Images to be provided in either TIF (.TIF) format with lossless (LZW) compression, TIF format with 100% quality JPEG compression, or JPEG (.JPG) format with 100% quality setting, on non-returnable external hard disk drive unit(s). The consultant needs to maintain the records for the time frame specified in the contract.
- An ASCII text file or csv shall be delivered consisting of a list of geographic coordinates of the horizontal and vertical control points as specified in [Section 2.5.2](#) and [Section 2.5.3](#).

Camera center information from airborne GNSS for the project on the first DVD or external drive, in ASCII text format should contain the following:

- Image #, Latitude and Longitude in degrees, minutes, and seconds.

3.5 Analytical Aerial Triangulation

If the consultant is directed to perform the Analytical Aerial Triangulation (AT), the consultant shall be provided with the aerial imagery, the file containing the Airborne GPS/Inertial Measurement Data (AbGPS/IMU) and the template to be used to report the AT results.

The consultant shall use Hexagon Image Station ISAT aerial triangulation software unless alternative software is approved by TDOT. The consultant shall use AT methods to densify and extend the ground control data.

The consultant shall perform manual measurements for the AT unless otherwise directed by TDOT. Additional image points shall be measured at the “Von Gruber” locations on the imagery unless otherwise directed by TDOT. Measure a minimum of 3 ray points at the “Von Gruber” points with the exception of the first and last images of the strip.

Weight factors of 0.1’ shall be applied for 3cm to 7cm accuracy class mapping and a weight factor of 0.2’ shall be applied for 10cm to 20cm accuracy class mapping. The overall sigma of 2 micron sigma shall not be exceeded for 3cm to 7cm accuracy class mapping and 4 micron sigma for 10cm to 20cm accuracy class mapping.

TDOT may provide the consultant with additional points that will be used as independent check points.

The consultant shall provide TDOT with a report outlining the procedures and methods used during the AT process. The report shall contain the statistics, exterior orientation and GPS statistics where applicable.

The AT solution report shall be provided in .pdf format and the digital data shall be provided as Hexagon ISAT Ascii format and shall be delivered by email or by ProjectWise exchange.

Accuracy of these programs must meet American Society of Photogrammetry and Remote Sensing's Positional Accuracy Standards for Digital Geospatial Data, Edition 1, Version 1.0.

3.6 Digital Mapping File Requirements

In order to establish standard parameters by which digital mapping is to be obtained, the following parameters have been established:

- All digital data must be recorded directly as a function of a photogrammetric workstation. Post-compilation (board) digitizing of graphic compilation will not be permitted.
- All mapping data must be delivered in TDOT Aerial Survey standards and compiled directly in (or translated to) OpenRoads Designer.
- All mapping data must be in accordance with the TDOT standards in level structure, symbology, and element templates.

All design files shall be submitted to the Office of Aerial Surveys as 3 dimensional (3-D) files. The files shall be delivered as follows:

- All planimetric features will be compiled and delivered along with the DTM features in a single 3D design file within the specified project limits in accordance with the specific project scope of work and the TDOT Mapping Manual.
- Files shall be compiled with coordinate values to the nearest one-thousandth (1/1000) of a foot. Coordinate values for all features shall be based on the ground coordinates indicated by the control data.
- A surface must be generated, and the triangles and contour levels left in the file for review.
- Digital delivery is acceptable unless file size exceeds email limits. LiDAR in LAS format should be delivered on a hard drive with the most current ASPRS standard classified point clouds.

3.7 Map Compilation Techniques

In order to establish standard parameters for map compilation, the following parameters have been established:

- Features shall be identified with the following MicroStation® element types as appropriate: cell, line, line string, connected (complex) string, linear patterns, area patterns, simple shapes, complex shapes, ellipses (including circles) and text strings. The following element types shall not be used: **Arcs and Shared Cells**.

- Features are to be labeled only as required for clarification. Labels shall be oriented along linear features or parallel to the flight line of the stereo model being compiled, so that the project beginning shall be at the left and the project end shall be at the right. The project beginning and end points are identified on the project work order.
- Road alignments shall be carefully compiled and consist of tangent line strings. Irregular curve compilation will be permitted only on meandering irregular alignments.
- Compilation on adjacent files shall butt match exactly.
- Each deliverable file shall be identified by the file name. The file names shall have the extension **.MFC** for the planimetric files and **.DTM** extension for the digital terrain model files.
- A Job Model Index shall be produced for each project. The CONSULTANT shall add each file name to the index.

3.8 Map Content

The following section parameters have been established for map content.

3.8.1 Control Points

GNSS and Traverse Points shall be shown with their coordinate values, properly symbolized and labeled.

3.8.2 Planimetric Detail

All stereo compilation, whether planimetric only or topographic, shall show all planimetric features that are visible and identifiable or interpretable on the aerial imagery and in accordance with the appropriate standards as outlined in [Section 3.2](#).

Particular attention shall be given to include all transportation and transportation-related features such as roads, railroads, bridges, canals, streams, dams, utilities and drainage ditches, etc., as well as other features along transportation corridors.

The widths of roads and streets shall be shown as the separation between curb faces or hard surface edges (white fog lines) as appropriate.

3.8.2.1 Title Block

Fill in the required information on the title block in each file.

3.8.2.2 Mapping Limits Line

Digitize mapping boundary; pull all detail cleanly to line. Do not plot line on final plots.

3.8.3 Topographic Detail

3.8.3.1 Contours

Contours shall be generated from the DTM's at the interval specified in the ASPRS Accuracy Standards for Digital Geospatial Data. No contours or spot elevations are required for planimetric only stereo compilation.

Contours shall accurately portray the shape of the terrain within specified accuracy standards. Special attention shall be given to contours at transportation and transportation-related features. Accuracy standards for contours notwithstanding, contours shall clearly reflect the crown or cross-slope of all paved areas, including roads, paved ditches, and curbs, and shall truly depict all drainage ways and sinkholes.

In areas obscured by tree cover or heavy vegetation, contours shall be omitted, and the area labeled "GROUND OBSCURED".

3.9 Digital Terrain Model Production

The following standard parameters are to be used for DTM production:

- DTM information should be contained in dedicated DTM files, which should contain nothing else! There should be no text at all in a DTM file. The points should be true points (lines of zero length), not symbols.
- Generation of DTM's using previously collected contours including Open Source Data will not be allowed.
- Information collected for the DTM's shall be stored in a standard OpenRoads Designer® 3D/DTM design file.

DTM's are to be collected from the stereo model in the following forms:

- Break lines
- Ridges
- Drains
- X, Y, & Z coordinate points identified at regular intervals along parallel lines. DTM's compiled from aerial flights should pay particular attention to the following:
 - Outside edge of paved shoulders
 - Roadway white fog lines
 - Center of lane white lines
 - Any ruts in roadway, including tops and bottoms
 - Top and bottom of curbs or curb and gutter
 - Ramps, bridges, and cross-roads
 - Spot elevations at high points and low points

All DTM files must be able to be merged and triangulated together.

3.10 Map Accuracy Standards

The following standard parameters for mapping accuracy have been established. Photogrammetric mapping shall follow the American Society for Photogrammetric Mapping and Remote Sensing Positional Accuracy Standards for Digital Geospatial Data (Edition 1, Version 1.0. November 2014. This document can be downloaded from https://www.asprs.org/a/society/committees/standards/Positional_Accuracy_Standards.pdf. Accuracy shall be based on the accuracy class as outlined on Table B.6 (page A15) contained in the above-mentioned standards.

Data shall be identified as “Tested” or “Untested.” For untested data, the following statement shall be included with the data delivery:

- *This data set was produced to meet ASPRS Positional Accuracy Standards for Digital Geospatial Data (2014) for a (cm) $RMSE_x / RMSE_y$ Horizontal Accuracy Class which equates to Positional Horizontal Accuracy = +/- cm at a 95% confidence level.*
- *This data set was produced to meet ASPRS Positional Accuracy Standards for Digital Geospatial Data (2014) for a (cm) $RMSE_z$ Vertical Accuracy Class equating to NVA = +/- cm at 95% confidence level and VVA = +/- cm at the 95% percentile.*

The accuracy class reported for the untested data shall be reported as the ground sample distance (GSD) of the imagery that was used to produce the mapping.

To test the data, a minimum of 20 points shall be established by ground survey methods. The points shall be painted target points on a hard, level surface. The positions shall be measured on the imagery and measured in the field. These 20 points shall not be used in the aero triangulation solution (AT) but will be independent of the AT solution. The positions of these points as measured within the mapping shall be compared with the positions that were surveyed.

The results of the image measurements and surveyed positions shall be reported in the following or a similar format:

- *This data set was tested to meet ASPRS Positional Accuracy Standards for Digital Geospatial Data (2014) for a (cm) $RMSE_x / RMSE_y$ Horizontal Accuracy Class. Actual positional accuracy was found to be $RMSE_x = (cm)$ and $RMSE_y = cm$ which equates to Positional Horizontal Accuracy = +/- at 95% confidence level.*
- *This data set was tested to meet ASPRS Positional Accuracy Standards for Digital Geospatial Data (2014) for a (cm) $RMSE_z$ Vertical Accuracy Class. Actual NVA accuracy was found to be $RMSE_z = cm$, equating to +/- at 95% confidence level. Actual VVA accuracy was found to be +/- cm at the 95% percentile.*

Collection parameters for Digital Terrain Models are shown in Table 7.

TABLE 7. COLLECTION PARAMETERS FOR DIGITAL TERRAIN MODELS

Image Resolution	Contour Interval	Profile Distance	Station Distance
3cm	1'	15'	15'
7cm	2'	25'	25'
10cm	5'	25'	50'
20cm	10'	50'	100'

Chapter 4. Surveying Procedures and Practices

This chapter details the various activities involved in the survey process, including data requirements and procedures for gathering and presenting the data. Recent developments in surveying technology have made many methods obsolete. In general, it is assumed that the surveyor is using total stations, data collectors, GNSS equipment, network real time kinematic (RTK), light detection and ranging (LIDAR), unmanned aerial vehicles (UAVs), data reduction software, and a computer aided drafting system. The requirements specified in this manual are intended to control the end product rather than intermediate activities, e.g., data collector formats. The required end product will be a complete survey in electronic format, certain check plots and required notes, and documentation. The requirements for each project will be defined first by the work order and then by this manual. Because of rapidly changing technology, data transfer methods will not be defined here. They will be a part of the Regional Survey Manager's instructions. A Survey Checklist for preliminary, field and office procedures has been developed to assure completeness, as well as a checklist for railroad survey files and a ROW and property line justification template. They must be completed and turned in with the survey. The checklists can be found at the following link:

<https://www.tn.gov/content/tn/tdot/roadway-design/tdot-cadd-support/ord-training-material/survey-checklist-documents.html>

4.1 Development of Survey CADD Files

In the following discussion, the surveyor is advised that CADD standards are maintained by the Design Division, CADD Section, and periodically revised. The surveyor is referred to the latest version of these standards, hereinafter referred to as the CADD Guidelines, for questions regarding colors, level structure, and other file format items. The CADD Section also maintains all files such as cell and font libraries that the surveyor may need. The Regional Survey Manager can direct the surveyor to the appropriate contact person. **Note:** All CADD files shall be in OpenRoads Designer format, shall conform to the standards set forth in the CADD Guidelines, and shall be of manageable size as set by the Regional Survey Manager. The Design Division's CADD standards and downloads can be found at the following links:

Bentley MicroStation SS2

<https://www.tn.gov/content/tn/tdot/roadway-design/design-standards/design-cadd-files.html>

Bentley ORD

<https://www.tn.gov/tdot/roadway-design/tdot-cadd-support/ord-resources.html>

4.1.1 General

The TNDOT.smd feature table file shall be used on all Microstation SS2 TDOT surveys. This file can be downloaded from the TDOT web site. This download also contains a list of these features.

<https://www.tn.gov/content/dam/tn/tdot/roadway-design/documents/TDOT-SURVEY-SMD-V8i-FEATURE-CODES.pdf>

Any project deliverables greater than 35 mb in size or too large to be sent as an email attachment should be delivered on a non-returnable USB hard drive to your TDOT project point of contact or uploaded online via a SharePoint site. Files of this size will typically be classified LiDAR LAS files, imagery, and other large format project deliverables.

The Consultant must preserve project records and all project deliverables for at least three years from the date the project was delivered.

A completed survey in MicroStation SS2 will consist, at a minimum, of the following items:

- A MicroStation® (.DGN) file containing all planimetrics
- A GEOPAK® (.TIN) file containing the digital terrain model (DTM)
- A GEOPAK® (.GPK) file containing points, lines, curves, spirals, chains, survey chains and parcels. Refer to TDOT CADD Guidelines for COGO element naming conventions.
- A Microsoft® Excel (.xls) file containing the R.O.W. acquisition table
- Other documentation or paper plots as set forth in the remainder of this manual
- Other computer files or paperwork as required

A completed survey in Bentley ORD will consist, at a minimum, of the following items:

- A Bentley ORD (Aerial Model.DGN) file (if necessary) containing all the Aerial Survey Data
- A Bentley ORD (Model.DGN) file containing all the Field Survey Data
- A Bentley ORD (Terrain.DGN) file containing a Terrain Model
- A Bentley ORD (Alignment.DGN) file containing all Preliminary Geometry
- A Bentley ORD (Utility.DGN) file containing the Utility Model
- A Microsoft® Excel (.xls) file containing the R.O.W. acquisition table
- Other documentation or paper plots as set forth in the remainder of this manual
- Other computer files or paperwork as required

4.1.2 The Planimetric File

4.1.2.1 Filename

This file shall have the form **11S001-33-SUR-FileCategory.DGN**. Table 8 further defines the survey naming convention. The detailed document can be found on the TDOT website under **ORD Resources >> Requirements and Guidelines >> ORD File Naming**.

TABLE 8. SURVEY FILE NAMING CONVENTION

Letter / Number Combination	Description
11	2-digit county number to identify the project county location (Appendix C.14). If a project spans multiple counties, the 2-digit county number (for file naming purposes) should be the county which comes first alphabetically.
S	Route classification: S: State Route(s) I: Interstate Route(s) B: Project includes both State and Interstate Routes L: Local Route(s) (city or county routes) A: SIA (State Industrial Access) C: LIC (Local Interstate Connector) N: No System
001	Route number/ownership: ###: Three-Digit Route Number (e.g., S001 for SR-1, I040 for I-40) or: CIT: City Street COU: County Road VAR: Various routes PLN: Planning Projects not on specific routes MSC: Miscellaneous (other than Planning) projects not on specific routes
-33	Dash + two (2) numbers to identify the GNSS project number (contact the Regional Survey Manager for this number)
-SUR	Dash + SUR (for Survey phase)
-FileCategory	Dash + file category name
.DGN	ORD file extension

4.1.2.2 Content

This file shall contain the following items within the limits of the project as specified by the Regional Survey Manager or set forth in the survey contract.

- A survey centerline (as required)
- All existing right-of-way and property with owners shall be shown in the CADD file ([Section 4.3.3](#), [Section 4.3.4](#) and [Section 4.10](#)). This file will be used to create the acquisition table. The Microsoft® Excel file (RowAcqTable.EXE) can be downloaded from the following TDOT web site:
- <https://www.tn.gov/content/dam/tn/tdot/roadway-design/documents/tdot-documents/survey-documents/others/ROWAcqTable.xlsm>
- All existing topography ([Section 4.3](#))
- Profiles of all survey centerlines with underground and overhead utilities shown shall be included in the survey file ([Section 4.5](#))
- Drainage Information as required ([Section 4.7](#), [Section 4.8](#) and [Section 4.9](#))
- Other survey data such as various notes and other items as set forth elsewhere in this manual

4.1.2.3 Notes

Refer to [Appendix C.4](#), [Appendix C.5](#) and [Appendix C.6](#) for examples of the above information. The surveyor is advised that the survey will not consist of finished sheets but will be in a CADD file. The CADD file will consist of a single long map with coordinate integrity maintained. Also, the examples show only certain levels plotted to indicate the information required. The CADD file will contain all the information shown on all the examples on the levels as specified in the CADD Guidelines.

The surveyor shall make every effort to assure the readability and usability of the completed survey for design work. This shall include checking for text overlaps. The surveyor shall consider which data will be displayed simultaneously as the design process continues and make allowances for placement of text and other data. The surveyor may need to look at the set level filters for these. It is understood that all contingencies cannot possibly be considered, but a reasonable effort shall be required.

It shall be noted that any file format conversions required, and any problems realized therefrom are the responsibility of the surveyor and that the end result of the turn-in files must be in a form in compliance with the CADD Guidelines.

4.1.3 The Digital Terrain Model

4.1.3.1 Definitions

The following definitions apply to all other discussions within this manual:

- **Digital Terrain Model (DTM)**: a set of three-dimensional random points and breaklines used to model the surface of the earth both horizontally and vertically.
- **Breakline**: Also known as a fault line, is defined as a discontinuity in the earth's surface such as the edge of pavement or shoulders. Other examples are the top of a sharply defined stream channel or the bottom of a man-made ditch. Breaklines are generally indicated by a sharply defined line on the ground surface rather than a smooth or rolling appearance.
- **Random Point (Spot)**: Those points which are not connected with any breakline but stand alone.
- **Link Lines (Triangle)**: Also known as triangle lines are the imaginary lines stored internally in a computer connecting the points used to interpolate information about the ground surface where no actual point exists.
- **Edge Lines (Boundary Lines)**: A line placed around the edge of data in an attempt to keep link lines from forming in areas where no data exists.

4.1.3.2 Filename

The DTM file shall be a binary .TIN file in OpenRoads Designer format.

4.1.3.3 Notes

A DTM is interpreted by the computer as a set of points connected by a series of link lines. The algorithms used to create the lines connect points to their nearest neighbor. However, in some instances the nearest point may not be the proper link connection. For example, the nearest point to a point on the top of a ditch cut may be a point on the opposite top. The proper link is in the bottom of the ditch, though, hence the need for breaklines. The computer algorithm will not allow a link line to cross a breakline. So, a breakline in the bottom of the ditch forces the links into the bottom instead of short circuiting across the top.

Breaklines may be required even when the ground shows no obvious discontinuity. The surveyor shall show adequate random points and breaklines to assure that the DTM accurately reflects the surface of the earth. Great care shall be taken in the development of breaklines in the area of bridges or other structures, in a stream, under bridges, etc. At bridge abutments, wing walls, ends of pipes and culverts, curbs, retaining walls and any other vertical-type situation, develop breaklines at the top and bottom of the feature.

Random points are generally collected in a gridded manner with a nominal spacing of about 25 to 50 feet. This spacing can vary widely from much smaller or much larger, depending on the regularity of the surface being modeled. The spacing and placement of random points shall be such as to assure the accuracy of the DTM.

4.2 Final Alignment and Topography

4.2.1 Alignment

4.2.1.1 General

The final alignment shall be computed as nearly as possible to that specified in the TPR. The Regional Survey Manager will furnish the Field Supervisor with all design criteria, the TPR, any available preliminary maps, TVA quad maps, control monuments, etc., and provide any needed assistance to establish the final alignment. If it is discovered that the alignment falls close to a wetland or “blue line stream” a line change shall be considered. Any significant deviation shall be approved by the Regional Survey Office. Alignments or portions thereof may or may not be field staked at the discretion of the Regional Survey Manager. If staked, all route surveys shall meet Second Order, Class II accuracy standards, and be tied to the TGRN ([Section 2.1](#)).

4.2.1.2 Stationing

Stationing of the mainline will always be shown in the direction of increasing log mile. Log miles are available for all Interstates and State Routes, and for almost all County and City Roads / Streets. If log miles are not available, stationing will be shown from South to North and from West to East. Interstates and State Routes crossing or intersecting with the mainline shall be stationing with their existing log mile. County and City Roads / Streets crossing or intersecting with the mainline shall be stationing left to right looking forward along the alignment. Stationing of crossroads shall be staggered to prevent any two crossroads from having the same or overlapping station value. Beginning stations shall be selected such that an alignment can be extended down station and not result in negative stationing.

4.2.2 Curves

All curves shall adhere to the latest TDOT standard roadway drawings and Design Guidelines. Exceptions shall be approved by the Regional Survey Office. The standard roadway drawings are accessible through the following TDOT website:

<https://www.tn.gov/content/tn/tdot/roadway-design/standard-drawings-library/standard-roadway-drawings.html>

The roadway design guidelines are accessible through the following TDOT website:

<https://www.tn.gov/tdot/roadway-design/design-standards/design-guidelines.html>

Circular Curves - All data is to be computed by the arc definition. Curve data shall be rounded to three decimal places.

4.2.3 Tangents

All bearings are to be calculated from the initial bearing from P.I. to P.I. P.I. coordinates shall be computed to four decimal places, then bearings re-computed to even seconds.

Bearings and beginning coordinate point are then held constant and P.I.'s and ending coordinates re-computed to four decimal places. These new coordinates and even bearings will be labeled on present layout sheets. Coordinates at the beginning and ending of all alignments, at all P.I.'s, and at intersection station equations shall be labeled.

4.2.4 Staking Final Alignment

4.2.4.1 Alignment Points

Iron pins, spikes, nails, or other material that can be located with a metal detector shall be used for curve points and significant POT's. Other points may be marked with stakes. All alignment points in cultivated fields shall be buried below the depth of cultivation and all points in yards or pastures shall be driven flush with the ground. Alignment points shall be staked at the discretion of the Regional Survey Manager.

4.2.4.2 Staking

The final alignment may be staked and marked at the discretion of the Regional Survey Manager, with the station number at least every 100 feet. Intervals for staking will be at the discretion of the Regional Survey Manager. When staking on existing pavement, all stations will be marked with a nail and the station painted on the pavement near the point. All stakes shall be removed from cultivated fields and hay fields when the survey is complete, or when requested by a property owner or tenant.

4.2.5 Reference Points

Project control survey points ([Section 2.1](#)) will serve as reference points for each project. They are to be referenced with permanent type material and documented in the planimetrics file. A table shall be placed in the planimetrics file, listing data for GNSS project control points, and total station (traverse closed and adjusted) project control points. The table lists point-number, northing, easting, elevation, station, and offset for each point. Station and offset refer to the mainline alignment only. Refer to [Appendix A](#) for examples.

4.3 Topography

4.3.1 General

It is important that all topography likely to be affected by, or that will affect, the proposed road be accurately located. This shall include all houses on properties that are in some way affected by the project. It is the responsibility of the Field Supervisor to determine limits of the topography. The limits shall include the proposed width of R.O.W. and possible limits of construction. Occasionally a building or drainage structure outside the construction limits will affect or be affected by the project; therefore, these shall also be located.

4.3.2 At Grade Road Crossings

Alignment, DTM, topography, and present R.O.W. shall be recorded for a minimum of **300** ft for State Routes and **200** ft for other roads. Exceptions to the minimum may be made at the discretion of the Regional Survey Office. The DTM shall be extended as necessary to assure proper information for grade ties of proposed to existing roadways. Bearings of centerlines and stations of the intersection shall also be shown. Any Railroad coordination needs to start with the TDOT Railroad Office.

4.3.3 Property Lines

The bearing and distance shall be shown along each property line in the planimetrics file. The station of intersection shall be shown at intersections with a R.O.W. line. If the property line does not cross the survey line, the right angle station and offset distance shall be shown for the property corner at the affected area. All angles to property lines will abide by the acceptable topo accuracies, and the bearings calculated from the survey line. Any curve elements need to have arc length, radius, chord bearing, and chord distance labeled. Deed bearings shall not be shown.

- **Riparian Owners (Title to Bed of Waterways Stream Beds):** Whether a particular waterway is navigable in the legal sense is a question of fact to be determined by a jury. The legal navigability of a waterway determines whether the land beneath those waters may be privately owned. If navigable, the title to the bed of waterway, to the low-water mark, is publicly owned by the State. Conversely, if non-navigable, then the land beneath the waterway can be privately owned. *Opinion No. 11-75, Office of the Attorney General, State of Tennessee.* Title to the stream bed that lies between the ordinary low water lines in a navigable stream is vested in the State for the use and enjoyment of the public at large. It is not susceptible to private ownership even when the deed calls for center of the stream. Title to stream beds in non-navigable streams is vested in the adjacent riparian proprietors.
- **Navigability:** The U.S. Army Corps of Engineers has declared certain waters to be “Navigable Waters of the United States” pursuant to the Rivers and Harbors Act of 1899. Determinations may be given substantial weight in determining ownership of the bed of the waterway. However, this determination is not binding on whether or not the waterway is navigable in the legal sense. A list of waters so designated by the Corps can be accessed on the US Army Corps site:
 - **Memphis District**
<https://www.mvm.usace.army.mil/Missions/Navigation/Heads-of-Navigation/>
 - **Nashville District**
<https://www.lrn.usace.army.mil/Missions/Regulatory/Navigable-Waters-List/>

The Tennessee Supreme Court has defined navigability this way: “A stream is navigable in a legal sense when it is capable, in the ordinary stage of water, of being navigated, both ascending and descending by such vessels as are usually employed for purposes of commerce.” *Holbert vs. Edens*, 73 Tenn. 204 (1880).

It is not navigable in a legal sense when: “as where, in certain stages of the water, it may have insufficient depth for flatboats, rafts, or small vessels of light draft.” *Holbert vs. Edens*, 73 Tenn. 204 (1880).

So, if a stream can float “flatboats, rafts, or small vessels of light draft” at all times of the year, it is navigable in the legal sense. If it can float such vessels only during flood time, it is not navigable in the legal sense. The fact that a stream has never been used for navigation is no bar to navigability if the potential for navigation is present.

- **Property Lines on Navigable Waters:** The Tennessee Supreme Court has said: “--the owners of land upon navigable streams have title to the ordinary low water mark--.” *Martin vs. Nance*, 40 Tenn. 649 (1859).
Ordinary low water mark was defined in another case: “The ordinary low water mark is the usual and common or ordinary stage of the river, when the volume of water is not increased by rains or freshets, occasioned by melted snow on one hand, or diminished below such usual stage or volume by long continued drought to extreme low water mark.” *Goodall vs. Herbert & Sons, Inc.*, 8 Tenn. App. 265 (1928).
- **Property Lines on Non-navigable Waters:** When the stream is not navigable, private ownership extends to the center thread of the waterway even if the deed calls for the edge or water line, unless there is a metes and bounds description or other intent not to extend to the center of stream.
- **Property Lines on TVA Lakes:** TVA property extends to the “Maximum Shoreline Contour” ([Appendix C.3](#)). A “Flowage Easement” around lakes, such as Norris, Cherokee, and Douglas may also be owned and shall be indicated. Easements may be investigated at the TVA property office closest to the lake in question.
- **Surveying Riparian Property Lines:** Enough data must be taken to enable the Designer to calculate the area of take. This means that the riparian property lines must be traversed, or located by offsets from base lines, by angle and distance with a total station or located by other suitable means.
- **Overlapping Deeds:** If an overlapping boundary line is discovered, both deed lines bounding the overlapped area shall be shown and the area labeled as “disputed” in the planimetric file. Discussions with the owners shall be documented on the Property Owner Contact Form ([Appendix C.1.1](#)).
- **Noncontiguous Deeds:** If no one claims the area between the deeds, the deed lines shall be shown, and the area labeled “owner unknown”. Discussions with the owners shall be documented on the Property Owner Contact Form.

- **Deed Search**: It is the responsibility of the surveyor to locate a deed for each piece of property affected by the project. It needs to be turned in with the survey and serves as a research record.
- **Subdivisions**: The recorded plats provide information but are not substitutes for locating property lines.
- **Evidence of Property Lines**: Tennessee Courts will try to determine from a deed the land which the parties intended to include in the conveyance. Evidence is generally given this order of preference:
 - Written Intention of the Parties to the Deed
 - Natural monuments
 - Man-made objects
 - Boundary lines of abutting property
 - Bearing and distances

4.3.4 Present Right-of-Way

4.3.4.1 General

There are only six (6) situations in which the State can successfully claim ownership of present R.O.W.:

- There is a recorded deed executed between the State, County, or Municipality and the present or prior owner.
- There is an unrecorded deed that can be located, executed between the State, County or Municipality and the present owner who is still living.
- There is a plat recorded by the present or prior owner which shows a R.O.W. width.
- There is an unrecorded petition between the present owner and the County.
- There is a R.O.W. monument on the property.
- Failing all five of the above, the State can only claim to the user's line, or if the user's line cannot be established, there is a presumption that the unascertained R.O.W. is 25 feet on either side of the centerline of the traveled portion of the road.

4.3.4.2 User's Line

Determination will be a matter of judgment, and only property being used by the State may be claimed.

For rural sections, evidence shall be given the following order of preference:

- Marked property corners
- Fence paralleling the road

The widest of the following:

- Limit of maintenance
- Toe of slope and back of ditch
- Edge of Shoulder
- Edge of Pavement

For urban sections, evidence shall be given the following order of preference:

- Marked property corners
- Back of sidewalk

The widest of the following:

- Limit of maintenance
- Toe of slope or back of ditch
- Back of curb or edge of pavement

The orders of preference given above for the user's line can be disregarded only if there is good reason, therefore.

When necessary, the Regional R.O.W Supervisor may be contacted for assistance in locating a user's line.

The user's line shall be labeled as "Pres. R.O.W." in the planimetrics file.

4.3.4.3 Old Right-of-Way Plans

Old plans sometimes exist for which there are no R.O.W. deeds. In this case, without physical evidence, the old plans are only circumstantial evidence of present R.O.W. and only the user's line may be claimed. Areas to the user's line shall be calculated.

In the event that the present R.O.W. cannot be identified and a user's line cannot be established for a two (2) lane undivided public road, there shall be a presumption that the unascertained R.O.W. is 25 feet on either side of the centerline of the traveled portion of the road. This presumption can only be made where the State proposes to improve the section of road. (TCA 54-22-101)

Information necessary for a complete description of R.O.W. lines (metes and bounds or coordinates) shall be recorded. All present R.O.W. metes and bounds, station and offset distances for all break points, the beginning and end of curve points, and property line intersection points along the present R.O.W. line shall be labeled in the planimetrics file.

1. Martin v. Nance, 40 Tenn.z04 (1880) and State v. Muncie Pulp Co., 104s.w.437 (Tenn. 1907)
2. Thornberg v. Chase, 106 s.w.zd672 (Tenn Ct. App. 1980) and Webber v. Kroger, No. M2019-00406-COA-R3-CV, Appeal from the Chancery Court for Davidson County (2019)

4.3.5 Land Character

The land character of rural areas such as pasture, second growth, cultivated, swampy, etc., shall be noted. There shall be no attempt to show boundaries of each character except for fences and tree lines.

4.3.5.1 Trees

Trees which may be affected by construction shall be recorded, including size and type. Tree diameters are measured at DBH, or Diameter at Breast Height, which is approximately 4.5 ft above the ground. The edges of wooded areas shall also be identified. Wooded areas should be defined, not necessarily individual trees. Individual trees should be defined where landscaping or mowing is apparent. Diameters are most helpful for appraisers determining cost for specialty or landscaping trees that are potentially being acquired or affected.

4.3.6 Existing Drainage Structures

- The direction of flow shall always be shown.
- The size, type, length, invert elevations, and type of foundation material (if determinable) of existing drainage structures shall be noted in the planimetrics file.
- Channel Changes
- The alignment shall be tied to the survey line.
- The DTM shall encompass any area affected by a channel change.
- Material used for channel lining shall be identified.
- Storm Sewers - The size and location of all pipes shall be shown. A recommended method is to give each catch basin and manhole a number so that each pipe can be identified. Example: 71 in x 47 in from 3 to 4.

4.3.7 Buildings

The number of stories shall be shown, such as:

- 1 F (one story frame)
- 2 B (two story brick)

Only the floors above ground shall be counted, and the abbreviations shown on Standard Drawings RD-A-1 and RD-A-2 shall be used. Additional identification such as res., barn, shed, etc., shall be used. All commercial property shall be noted in the planimetrics file by name, e.g., "McDonald's Restaurant".

RD-A-1

<https://www.tn.gov/content/tn/tdot/roadway-design/standard-drawings-library/standard-roadway-drawings/standard-roadway-title-sheet--abbreviations-and-legends/rd-a-1.html>

RD-A-2

<https://www.tn.gov/content/tn/tdot/roadway-design/standard-drawings-library/standard-roadway-drawings/standard-roadway-title-sheet--abbreviations-and-legends/rd-a-2.html>

At least two corners on all buildings shall be located and measurements of the buildings shall be obtained so they can be plotted accurately. In business districts, all doors and loading docks shall be shown with floor elevations noted. Also, the floor elevation shall be shown for all buildings near drainage structures in flood prone areas.

4.3.8 Ramps and Driveways

All existing ramps and driveways shall be accurately located.

4.3.9 Underground Petroleum Storage Tanks

The disposition of property containing underground petroleum storage tanks is of utmost importance to TDOT. Environmental requirements call for expensive procedures to assure that leakage does not occur during any activity affecting the property. Because of the expense involved, TDOT must carefully consider such property when planning or constructing a roadway project. The ideal solution would be to avoid such property. This, however, is not always possible.

An attempt will be made to locate and identify all such property during development of the TPR. Proposed alignments will then be located so that the property can be avoided if possible. All such tanks, currently in use, shall have a certificate (or tank identification) number issued by the Tennessee Department of Environment and Conservation (TDEC).

In the event that such property is unavoidable, all tanks shall be located as accurately as possible and recorded in the planimetrics file. The Facility Identification Number shall also be shown. Accurate location of the underground tanks is often difficult. However, all possible sources of information shall be investigated (conversation with tenants, request for plans from owners, etc.). TDEC personnel can also be contacted and may be aware of additional information (including the Facility Identification Number) in their files. They may be reached at (615) 532 0945 in Nashville.

Occasionally property with tanks not identified in the TPR will be encountered. This is more likely when the tanks are not in use. The property and existing tanks shall be brought to the attention of the Regional Survey Manager for consideration of moving the survey line to avoid the property. If this is not possible, the property and tanks shall be located as discussed above. If the tanks are in use, the TDEC office shall be contacted as mentioned above, for a Facility Identification Number.

4.3.10 Other Topographic Features

Ornamentation on private properties such as signs, raised planters, etc. shall be shown and labeled in the planimetrics file. Parking lots and parking spaces (within survey limits) shall also be located in the planimetrics file. These items affect the appraisal of the property.

4.3.11 Field Notes

Field notes are not a required part of the survey. However, a field book shall be kept to record information which would be of use during data analysis and editing, development of plots, and review of activities. Examples: conversations with property owners, utility company employees, etc.; sketches of unusual locations or situations; descriptions of potential problems or locations; descriptive data to be entered into files later.

4.3.12 Plotting

4.3.12.1 General

The alignment and topography shall be plotted to check the planimetrics file.

4.3.12.2 Scale

A scale of **1"=50'** shall be used unless otherwise directed by the Regional Survey Office or Design Division.

4.3.12.3 Coordinate Values for P.I.'S

Coordinate values for all P.I.'s shall be shown in the planimetrics file as part of each curve data table. Coordinate values shall also be listed for the beginning and ending points of all alignments and intersection station equations.

4.3.12.4 Complete Names

Complete names as shown on deed shall be used on present layout sheets and property tables. The term "ETUX" shall be avoided.

4.4 Bench Levels and Check Levels

4.4.1 Vertical Datums

All vertical datums shall be tied to monuments established by the National Geodetic Survey (NGS). **Note:** Assumed datums or the use of GNSS to establish vertical control will be used only when authorized by the Regional Survey Manager.

4.4.2 Methods and Accuracy

Benchmarks will be set, and check levels run before they are used for development of the DTM. Third order accuracy shall be obtained before adjustments are made (Refer to [Appendix C.7.2](#) for definition). Check level calculations shall be shown in the notes of the field book or survey control report (Refer to [Appendix C.8](#) for examples of field notes).

4.4.3 Benchmark Location

Benchmarks may be set every 1,000 ft along the survey and near all major structure sites and major intersections. All Benchmarks will be permanent in nature. Usually, GNSS project control points can be used as benchmarks. Avoid using nails or spikes in trees or poles. Trees are injured and also lose their value with nails in them. Typically, utility companies prohibit placing nails in their poles.

4.4.4 Descriptions

All Benchmarks are to be fully described. Example: B.M. No. 35, elev. 594.68, Aluminum disk atop 5/8" rebar stamped "HV-4" driven flush to the ground, 160 ft right, Sta. 24+45.00.

4.5 Profile and Cross Sections

4.5.1 Procedures

4.5.1.1 General

Profiles, including drive and ramp profiles, are typically generated from the DTM and no separate procedures are required in the field. However, there may be an occasional situation for which the Regional Survey Manager would require a conventional profile. It is for that reason profile methods and procedures are outlined below. Many of the methods described below shall be observed when developing profile plots from the DTM. Cross sections are no longer used by TDOT as a method of gathering field data and they are not plotted as part of the survey function. Therefore, cross sections procedures are not considered in this manual.

4.5.1.2 Requirements

Profile shots shall be taken at the beginning and ending stations, and at every 50 ft station. The profile shall also be taken at all breaks or abrupt changes in ground elevation.

4.5.1.3 Methods

The Direct Rod Reading Method shall be used when taking a profile with a surveyor's level. Readings shall be made to the nearest 0.1 ft on soil, rock, or gravel surfaces, and to the nearest 0.01 ft on asphalt or concrete surfaces.

4.5.1.4 Driveway and Ramp Profiles

Driveway and ramp profiles shall be taken at **25** ft intervals for a distance sufficient to accommodate ties to proposed grades. All profiles shall be tied to the centerline of survey, not some physical object such as edge of pavement.

4.5.1.5 Side Roads

Profiles shall be taken for the limit of the alignment at **25** ft intervals with additional profile, if required, to accommodate ties to existing grades.

4.5.1.6 Trigonometric Methods

Trigonometric profiling may be used when the terrain is rough, or elevation differences are great. The field notes must be in such form that they are easily interpreted by others.

4.5.1.7 Notes

An example of profile notes is included as [Appendix C.8.4](#). Notes must be checked and initialed in the field book.

4.5.1.8 Data Collectors

When field data collectors are used, a tabulated list of offsets and elevations must be produced.

4.5.2 Profile Plotting

Refer to [Appendix C.5](#) for examples.

4.5.2.1 General

Profile plots shall be generated to check data in the planimetrics file and turned in with the survey. Standard OpenRoads Designer profile tools shall be used with the horizontal scale the same as that used for present layout plots. The desirable ratio is one (1) vertical to ten (10) horizontal.

4.5.2.2 Items to be Plotted

- Profile of the survey centerline or baseline
- Profiles of all side road centerlines or baselines
- Profiles of the tops of each rail for a railroad crossing (at-grade and separated) for a minimum of 300 ft in each direction
- Profiles of storm and sanitary sewer lines within the roadway (back of shoulders or sidewalks)
- Storm and sanitary sewers and major utilities, e.g., gas transmission lines which may be affected by roadway or structure construction
- Benchmark descriptions and elevations or control point descriptions and elevations, if they are used for vertical control

- All intersection equations
- Drainage information, including structure plotted, station, skew and direction of flow in reference to the alignment that your profile is cut upon.
- Low wire crossing information, including wire type, clearance, station, and temperature if a high tension line
- High water marks, ordinary high water marks, and normal water marks at stream crossings or at intervals when the centerline parallels streams
- Vertical datum and stationing properly shown (example: “All elevations are referenced to NAVD 1988”)
- Labeling for each item shown
- Profile plot labeled with project description

The survey file shall contain the following disclaimer within the survey seed file, that depths to some utilities are approximate, and profiles shall not be considered as accurate representations of their locations:

THIS SURVEYOR HAS NOT PHYSICALLY LOCATED THE UNDERGROUND UTILITIES. ABOVE GRADE AND UNDERGROUND UTILITIES SHOWN WERE TAKEN FROM VISIBLE APPURTENANCES AT THE SITE, PUBLIC RECORDS AND / OR MAPS PREPARED BY OTHERS. THEREFORE, RELIANCE UPON THE TYPE, SIZE AND LOCATION OF UTILITIES SHOWN SHOULD BE DONE SO WITH THIS CIRCUMSTANCE CONSIDERED. DETAILED VERIFICATION OF EXISTENCE, LOCATION, AND DEPTH SHOULD ALSO BE MADE PRIOR TO ANY DECISION RELATIVE THERETO IS MADE. AVAILABILITY AND COST OF SERVICE SHOULD BE CONFIRMED WITH THE APPROPRIATE UTILITY COMPANY. IN TENNESSEE, IT IS A REQUIREMENT, PER “THE UNDERGROUND UTILITY DAMAGE PREVENTION ACT”, THAT ANYONE WHOM ENGAGES IN EXCAVATION MUST NOTIFY ALL KNOWN UNDERGROUND UTILITY OWNERS, NO LESS THAN (3) THREE OR NO MORE THAN (10) TEN WORKING DAYS PRIOR TO THE DATE OF THEIR INTENT TO EXCAVATE AND ALSO TO AVOID ANY POSSIBLE HAZARD OR CONFLICT. TENNESSEE ONE CALL 1- 800-351-1111.

4.6 Drainage Surveys

4.6.1 Drainage Areas

An example is included as [Appendix C.6.1](#).

4.6.1.1 Methods

Drainage areas will be drafted and described for all existing drainage conveyances crossing the survey centerline. Areas will be delineated by field surveyed terrain, USGS Topo Data and/or Aerial photogrammetry / LiDAR data. Drainage area boundaries / divides within the topo limits of the project shall be determined from field surveyed data.

4.6.2 General Requirements for Bridge and Culvert Surveys

4.6.2.1 Definitions

EXTREME HIGH WATER: the highest elevation to which evidence can be found that water has ever risen (If the drainage basin has been altered, the highest elevation since that time).

NORMAL POOL: this elevation is identical to ordinary high water but is applied to lakes and wetlands.

NORMAL WATER: the water surface elevation during normal weather conditions (no flood runoff).

ORDINARY HIGH WATER: the water surface elevation of the vegetation line.

4.6.2.2 Field Data

The extreme high water, normal water, and ordinary high water elevations are required.

4.7 Drainage Site Surveys

Unless directed otherwise by the Regional Survey Office, the following two (2) types of drainage site surveys will be made:

- **BRIDGE SURVEYS:** survey for sites with Q50 greater than 500 cfs or any structure whose length along the roadway is 20 feet or greater.
- **PIPE AND BOX CULVERT SURVEYS:** survey for sites with Q50 up to and including 500 cfs.

The drainage area will be used in conjunction with the Hydrologic Areas Chart ([Appendix C.15.1](#)) and/or USGS streamflow statistics to determine if a bridge or culvert survey is performed.

4.8 Bridge Surveys

(Q50 = GREATER THAN 500 CFS OR ANY STRUCTURE WHOSE LENGTH ALONG THE ROADWAY IS 20 FT OR GREATER) - Each bridge survey shall have a corresponding Bridge Survey Notes block submitted with the project data. This block will be added via the Place Cell tool in the Utility.dgn file.

4.8.1 Stream Baseline Alignment

Create a stream baseline generally following the stream meanders and parallel with the direction of stream flow. The baseline shall be treated the same as a sideroad horizontal alignment except being placed on CADD levels for stream alignments. Stationing will be in the direction of the flow of the stream. Station the stream baseline such that no stations are shared with other nearby alignments.

If up and downstream cross sections are requested, their alignments shall also be plotted and stationed such that the up and downstream sections are plotted looking downstream.

4.8.2 DTM Development

Develop DTM in the stream channel such that 2-foot contours can be generated. Use a combination of point and break field surveys and bathymetric survey methods to capture the meanders and accurate DTM between and extending 10 feet outside of the apparent top of bank of the stream and extending up and down stream as follows:

- **Bridges:** Channel DTM extends 3 times the bridge length up and down stream of the existing bridge or a minimum of 100 feet.
- **Culverts:** Channel DTM extends 1 times the inlet-to-outlet culvert length up and down stream from the inlet and outlet of the existing culvert or a minimum of 100 feet.

If the channel of the stream and structures cannot be surveyed safely or if by using this calculation, the length of the bridge or length of the culvert creates a channel survey footprint disproportionate to the scope of work, contact the regional survey office for specific guidance from TDOT Hydraulics.

In the immediate area of the structure, the DTM shall be developed such that accurate 0.50' contours may be produced. The immediate area must be wide enough to cover the limits of construction, and long enough to cover the proposed structure and approaches. This will simplify design of slope protection for approach fills. Existing bridges and the TPR may be used as a guide for length.

4.8.3 Topography

Complete topography shall be taken to include stream meanders. Meanders of bank tops, bottom of banks, and water surfaces shall be recorded. Locate all existing topo features and all stream features within the DTM development limit of the stream discussed in [Section 4.8.2](#). Describe and locate features with their dimensions that would obstruct the flow of flood waters.

4.8.3.1 Buildings and Other Structures Subject to Flooding

The structure shall be located, and floor elevation recorded along with structure type and use (i.e., business, residence, etc.). **Note:** Lowest elevations where flood damage may begin (crawl space vents or HVAC units).

It will be necessary to document any structure that is replaced. The existing structure shall be located and described with dimensions of waterway openings shown. Also, wingwall geometry, retaining walls, rock ledges, or previously abandoned structures in the area shall be located and defined.

4.8.3.2 Existing Structures

Each bridge or culvert along the existing route within the flood plain shall be located with beginning and ending stations shown for the bridges. An elevation view sketch of each shall also be developed ([Appendix C.12](#)). They shall be drawn to scale or have all dimensions of the waterway opening shown. The low beam elevation shall be recorded for bridges and the inlet and outlet invert elevations for culverts. Pier and deck elevations may also be required. Locate any structures along stream within the profile length. Describe with sketches or descriptions of their grades, lengths, widths, and dimensions as needed to determine the impact to flow of flood waters.

4.8.3.3 High Water and Normal Water

The elevations of extreme high water and normal water levels shall be recorded with a description of how the extreme high water was determined (including date). If the extreme high water level is backwater the name of the river or lake shall also be noted. These elevations shall be the best estimate in the field based on local knowledge of property owners, debris and mudlines, historic photographs, and FEMA maps where available.

4.8.4 Stream Profile

Extract and draft stream profile grades along the stream alignment showing the stream channel bottom and normal water elevation. Digitize alignment stationing and alignment intersections.

Stream alignment and profile shall extend up and down stream as follows:

- **Bridges:** Profile extends 3 times the bridge length up and down stream of the existing bridge or a minimum of 100 feet.
- **Culverts:** Channel profile extends 1 times the inlet-to-outlet culvert length up and down stream from the inlet and outlet of the existing culvert or a minimum of 100 feet.

If the channel of the stream and structures cannot be surveyed safely or if by using this calculation, the length of the bridge or length of the culvert creates a channel survey footprint disproportionate to the scope of work, contact the regional survey office for specific guidance from TDOT Hydraulics.

4.8.5 Questions

Questions concerning a particular bridge survey shall be directed to the Regional Survey Office.

4.8.6 ORD Deliverables

Information must be provided in the planimetrics files and terrain model such that a plotted bridge survey complete within itself can be produced. The Road Designer will develop the following plots and forward them to the structures Division, Hydraulics Design Section along with electronic files (.dgn and .tin).

4.8.6.1 Topography

TEXT: Stream Name, alignment stationing and labels, water marks and elevations, comments, and descriptive Data.

DATA: Stream meanders with edge of normal water and top of banks shown, existing structures and topo features, buildings subject to flooding with floor / fixture elevations.

4.8.6.2 Profiles (Generated from DTM)

TEXT: Stream Name and Flow Direction, Alignment intersection labels, Comments and descriptions, hydraulic information block for bridges.

DATA: Stream Profile with Stream Bottom and Normal water grades projected along the profile length.

Stream channel and floodplain cross sections may be requested in addition to the terrain model captured to complete hydraulic analysis.

4.8.6.3 Sketches

Drawings of existing structures may be shown separately or within the Alignment file. They shall include all data described in [Section 4.8.3.2](#) (Refer to [Appendix C.12](#) for examples).

4.9 Pipe and Box Culvert Surveys

($Q_{50} = 0$ cfs to 500 cfs) - Separate surveys for these structures are not required. However, certain data must be gathered during the topographic survey and measures taken during DTM development to assure information is provided to allow for proper design.

4.9.1 Topographic Surveys

Data gathered during topographic surveys will be shown in the planimetrics file and includes stream and/or ditch meanders, and existing structure details such as endwalls, wingwalls, etc.

4.9.2 DTM

The DTM shall be developed in greater detail in the area of the existing structure and flow. Spot elevation shots and breaklines shall be recorded at the bottom of ditches or center of stream and the DTM shall be extended far enough to determine the natural profile of the stream or ditch.

4.9.3 Text

Certain descriptive information shall be recorded in the area of the pipe or structure, including:

- Condition and other comments
- Foundation material
- Invert elevations

4.9.4 Erosion Control

Retention ponds and other special drainage features will be designated by the designer and may require additional field information at the time of design. Other data shall be provided as part of usual drainage surveys. A contour map of the area (scale no smaller than 1:5000) will supply required drainage information and is the designer's best source of information for erosion control ([Section 4.7](#)).

4.10 Property Map

4.10.1 Procedures

Information will be gathered and shown in the planimetrics file such that a property map can be prepared for every project which requires R.O.W. and/or easement acquisition.

4.10.2 Sources of Information

- Deeds and plats
- Field Information ([Section 4.3.3](#))
- Tax maps
- Aerial mapping
- Planning commissions, agency engineer
- Private survey firms

4.10.3 Map Limits

Each affected property shall be shown in its entirety, including all access roads. However, very large tracts do not need the entire boundary surveyed in the field. A field survey shall be performed and labeled with metes and bounds on the property to a width that will show on the present layout sheet. Outside this width, the area may be scaled or digitized from tax maps or deeds and shall not be labeled.

4.10.4 Tract Numbers

Each tract shall be numbered consecutively from the beginning of the project, crisscrossing the road as necessary. A separate tract number shall be assigned for each separate deed, even though adjoining tracts may have the same owner.

4.10.5 R.O.W. Acquisition Table

The table shall be consistent with the Acquisition Table in the Design Guidelines ([Appendix C.2](#)), and as called for in [Section 4.1.2.2](#).

The following will be recorded unless the Regional Survey Office directs otherwise:

- Deed area right and left of survey centerline unless there is an obvious difference in deed area versus tax assessor data or calculated area or unless a tract boundary is completely resolved. Then the tax assessor data or calculated area will be used.
- Areas to the nearest square foot
- Deed book and page number
- Tax Map and Parcel Numbers

4.11 Grade Separations (Roadway)

When it is proposed to construct, widen, or replace a bridge over a road, the following procedures apply:

4.11.1 Field Data Required

- The station of intersection shall be noted.
- Alignment and topography shall be taken 500 ft right and left on rural roads and 1,000 ft right and left on state routes. Deviation from these limits shall be approved by the Regional Survey Office.
- The DTM of crossroads shall be recorded for the limits of the alignment.
- A detailed DTM suitable for development of a 6-inch contour interval map for separation structures shall be taken.
- When the proposed bridge will be located near the present structure, the vertical clearance and offset distance from the proposed centerline to the existing structure shall be recorded to the nearest 0.1 ft.

4.11.2 Plotting

Data shall be recorded in the planimetrics and DTM files necessary to prepare the following plots:

- Proposed roadway and crossroad profile
- Ground line contour map (6-inch intervals)

- As-built survey if needed
- Topography and alignment of bridge approaches, crossroad approach with any drainage structures, and flowline elevations

4.12 Railroad

Once scoping is discussed with the design manager, the following procedures should apply for resurfacing projects, new alignments, and bridge widenings/replacements.

4.12.1 Field Data Required

This applies to separated and at-grade.

- Station of intersection of each set of rails and spacing between tracks
- Alignment of all tracks, a minimum of 300 ft each direction with curve information (if any) computed and recorded in the planimetrics file
- All topography within the railroad R.O.W. for a minimum 300 ft each direction, including switching devices, signal devices, control boxes, and utilities (especially fiber optic cables)
- Name of the railroad
- Present railroad R.O.W.; the term “Easement R.O.W.” does not indicate that the railroad owns the property. To distinguish between R.O.W. in the planimetric, use line type “7” instead of the existing R.O.W. line type.
- Distance and direction to the nearest milepost and description of same
- Profile of the top of rail a minimum of 300 ft each direction
- Size, type, material, invert elevation and condition (if required) of all existing drainage structures with the direction of flow in field drains and channels indicated by arrows
- For proposed bridges that will be located near the present structure, the offset distance from the proposed centerline to the existing structure (to nearest 0.1 ft) and the location and vertical clearance from top of rail to bottom of beam
- Property lines of each set of rails
- Plotting – Refer to [Section 4.12.2](#) for additional plotting information

Note: The **CSX Public** Project Manual can be accessed here for reference: <https://www.csx.com/index.cfm/library/files/about-us/property/public-project-manual/>

Note: The **Norfolk Southern** Public Project Manual can be accessed here for reference: http://www.nscorp.com/content/dam/nscorp/ship/shipping-tools/Public_Projects_Manual.pdf

4.12.1.1 Railroad Air Rights

When an overpassing structure impedes the Railroad's capacity to use their easements, rights, or property for Railroad purposes, the Department is required to compensate the Railroad for the encumbrance imposed on the Railroad. Air rights are a type of easement obtained by the Agency to compensate the Railroad for limiting the Railroad's use of their property or easement vertically or horizontally. Air rights are generally bounded by the abutments on either side of the Railroad Corridor and furthest dimensions of the superstructure – generally the parapet walls on either side of the structure. In some cases, the proposed structure does not span the Railroad ROW but in all cases the Air Rights are limited to the dimensions of the superstructure. Air rights will never be acquired from the Railroad for at-grade crossings or crossing where the Railroad operates above a transportation facility. See the following link for more information on the types of easements needed for railroad projects:

https://www.tn.gov/content/dam/tn/tdot/roadway-design/documents/design_guidelines/DG-C4.pdf

4.12.1.2 Permanent Railroad Easements

Permanent Railroad Easements include all properties the railroad has rights to prior to the project but will no longer have rights during and after construction. Examples of permanent easement are slope pavement and foundations for abutments, bents, and columns.

4.12.2 Plotting

Data shall be recorded in the planimetrics and DTM files as necessary to prepare the following plots:

- Roadway profile
- Ground line contour map (6-inch intervals)
- As-built survey, if needed
- Profile of top of rail(s) 300 ft each direction
- Topography and alignment of proposed centerline of bridge approaches and tracks 300 ft each direction including any drainage structures (with flowline elevation), distance and direction to the nearest milepost and description of same, and present railroad R.O.W

4.13 Bridge Widening

4.13.1 Bridge Widening Projects

In the event a structure is to be widened, the following information will be required in addition to that indicated in [Section 4.11](#) or [Section 4.12](#):

- An as-built survey is needed for the existing structure. Dimensions and elevations shall be recorded to the nearest 0.01 ft, since new concrete must be tied to old. Attention shall be given to details of elevation on low girder, top of footings, abutments, piers and beam seats.
- The thickness of paving added to the structure shall be estimated.
- Existing plans or sketches prepared by bridge inspection teams shall be requested (if available) and may be used for checking and / or recording as-built dimensions. Specific requests for survey information may be made by Structures Division personnel.

4.14 Other Surveys

4.14.1 Staking Right-of-Way

R.O.W. staking is usually requested by Regional R.O.W. Offices and is used by appraisers and buyers to field locate property parcels.

Stakes shall be set so that an observer can easily see from one stake to the other. When an obstruction is encountered (building, large tree, boulder, etc.), a stake shall be set adjacent to and on each side.

When possible, a standard 1" x 2" x 36" stake shall be used and marked as directed by the Regional Survey Supervisor. When a R.O.W. corner falls on pavement, a nail shall be set and painted. Since these points can be expected to be semi-permanent the same degree of accuracy used on the survey will apply.

The method used to establish R.O.W. shall be based on sound engineering principles. Iron pins and / or R.O.W. stakes will be set as follows:

- At R.O.W. angle points (stakes and pins)
- At the beginning and end of each radius (stakes and pins)
- At the intersection of property lines and R.O.W. lines (stakes only)
- Near all structures which are positioned close to the margin, so that the relationship of the R.O.W. limit to the object can be determined visually (stakes only)
- When stakes are hidden by vegetation (e.g., cultivated areas, weed cover, thicket, etc.), they shall be marked with a witness flag which will protrude above the expected growth of vegetation

R.O.W. stakes will be marked with description / station / offset. The following standard abbreviations shall be used (Reference [Standard Drawing RD-A-1](#)):

- PRES – Present
- PROP – Proposed
- R.O.W. or R/W – Right-of-Way
- ESMT – Easement
- BEG R – Begin Radius
- END R – End Radius
- PERM – Permanent
- COR – Corner

Present R.O.W. shall not be staked unless so directed by the Regional Survey Office.

The point at which the centerlines of the proposed alignment and any existing roads cross shall be marked when staking R.O.W. The marking shall consist of a pavement nail, with flagging, circled by pavement marking paint with the centerline station painted on the pavement nearby.

Easements - Permanent easements shall be staked using the same procedures used in R.O.W. staking. Temporary easements shall be staked as accurately as supplied information permits (stakes only).

4.14.2 Staking Sounding Holes

The location for soil samples is selected by the Geotechnical Operations Section. Two copies of the proposed Layout Sheet will be sent with the desired drilling site and labeled numerically. All field work necessary to obtain ground elevations will be recorded on one of these sheets and maintained in the project file. The other will be returned to the Geotechnical Operation Section with the elevation of the ground shown at each hole site (Refer to [Appendix C.10.1](#) for an example).

The actual field staking may be done with a cloth tape or other method giving similar or greater accuracy and marked with a standard 1" x 2" x 36" stake, or as directed by the Regional Survey Supervisor. The identifying labels on the stakes shall agree with those shown on the layout sheets.

Points which fall in water that is too deep to wade in shall be referenced so that drill crews can locate them with tape or chain.

4.14.3 Additional Surveys

The methods and procedures used for gathering, recording, and editing additional surveys are generally the same as those used for the original survey. The primary problem encountered is the difficulty in separating additional data from original data. Additionally, survey updates are frequently required after the original survey files have been delivered to the designer and are being actively used in plan development.

Additional surveys will be reviewed in the same manner as the original surveys unless otherwise directed by the Regional Survey Manager. At the time an additional survey is initiated, the surveyor will request the latest “design” version of the survey files from the designer. The survey files would be unavailable for additional edits by design during this time. Upon completion, the surveyor will return the combined files to the designer and provide both the updated files and combined files to the reviewer.

- **Model.dgn**: Surveyor can import the additional fieldbook and only annotate that data, to avoid touching the previously annotated field data.
- **Alignment.dgn**: One overall updated alignment needs to be created (survey CL only – survey updates; proposed CL – design updates).
- **Terrain.dgn**: Create additional tin and then merge the overall tin and additional tin (surveyor should update).
- **Utility.dgn**: Add any additional nodes and conduits into the model. If a conduit gets extended, updated the original model (surveyor should update).

4.14.4 Updates

The old survey shall be carefully checked to determine where changes have occurred, and new data exists. If changes are minor, plans can be marked. Otherwise, procedures would be the same as for additional information in [Section 4.14.3](#).

Chapter 5. Care and Maintenance

Standard survey crew equipment is defined as equipment typically required to complete all types of TDOT survey tasks. This list of required equipment should be modified to meet specific project requirements. This should allow for flexibility in adding tools, accessories, and personnel to meet local conditions and requirements. Each office and crew should select the items and quantities best suited to meet its requirements.

The overall demand for calibration certificates confirming the measurement quality of new or used surveying equipment is increasing. This is mainly due to the fact that more and more surveying companies or their contractors are becoming ISO 9001 certified and therefore need to confirm the accuracy of their equipment periodically.

5.1 TDOT

5.1.1 General

TDOT has a large investment in surveying equipment and survey parties are expected to protect that investment by exercising proper care. Surveying equipment is made to withstand normal use, but it cannot be expected to perform accurately if it is misused. Therefore, every piece of equipment shall be used only for the purpose it was designed. The person in charge of the survey crew is personally responsible for the care and maintenance of survey equipment assigned to his work unit. Any employee who does not at all times show proper regard and care for survey equipment may be suspended or dismissed. The following are guidelines for use, care, and everyday maintenance:

5.1.2 Total Stations and Levels

- The instrument should be attached to the tripod snugly, but not so tight that the tripod head or spring plate becomes warped.
- The instrument should be held by the standards and tribrach (if applicable) when placing it on the tripod, not by the telescope or other parts.
- Lenses should not be touched with fingers. Lens cleaning fluid and eyeglass tissue, or a camel's hairbrush should be used for cleaning.
- The instrument should be kept free of dirt and grease. If foreign matter is allowed to accumulate, it will eventually penetrate into the motions and cause sticking. The plastic hood should be used to protect the instrument in dusty conditions.
- The instrument should be kept dry. However, if it does get wet, it should be air-dried.
- An instrument should never be left unattended.

- The instrument should be in its carrying case when transported in a vehicle or when walking long distances, and never transported in a vehicle on one's lap or left on the tripod. Transporting equipment mounted on tripods can cause maladjustment and damage.
- When using the motions of the instrument, they should be clamped just enough that rotation about the axis will not occur with slight pressure. Motions shall never be forced. The instrument should be rotated gently with the fingertips rather than forcefully with a grip. If screws or motions operate too tightly, adjustments should be made. No part of an instrument should be removed, or adjustments made, without thorough knowledge of the procedures involved.
- When placing the instrument back in its case, it should be positioned and secured properly with the motions clamped lightly.

5.1.3 Total Stations

- Total Stations should be loaded in vehicles, so movement and jarring is minimized.
- Required maintenance is minimal on most instruments. However, protection from the elements and routine external cleaning are necessary.
- A total station should never be pointed directly at the sun. The focused rays of the sun can damage receiving elements.
- Prisms should be kept in their cases when not in use.
- Prisms must be kept clean to assure maximum reflection.
- When prisms are set up near a high-speed road or in a strong wind, they must be secured so they will not blow over.
- Between setups, total stations should be transported in their storage/carrying case.

5.1.4 Tripods, Level Rods, and Other Equipment

- Tension should be kept on tripod legs so they will just fall freely.
- Mud shall be cleaned from tripod shoes and legs at the end of each workday, and dirt and mud cleaned from level rods and range poles as needed.
- Tripods, level rods, or other equipment should never be thrown into a vehicle or leaned against vehicles, trees, or buildings. Level rods should be laid flat or held vertically. Tripods should rest with the legs spread and firmly set in the ground.
- Clamps on extendable leg tripods should be just tight enough to avoid slippage.
- Other material (stakes, axes, etc.) should not be loaded on top of tripods, level rods, range poles and other such equipment.
- When walking, level rods should be carried with the numbers facing in or out (not up or down), so the rod does not bounce, or bend while being carried.
- Level rods, range poles or other equipment should not be used for unauthorized purposes such as prying, vaulting, hammering, digging, prodding, etc.

- The moving parts and clamps of tripods, level rods and other equipment shall be oiled occasionally. Also, screws and bolts shall be checked periodically for tightness to assure rigidity.

5.1.5 Global Navigation Satellite System (GNSS) Equipment

- Refer to manufacturer's recommendations for detailed care and maintenance.
- Most GNSS equipment is water resistant and not waterproof.
- Over charging protection is typically built into the equipment.
- If using an RTK base station, place the base station on a point that is not likely to be in danger of being hit by a vehicle.
- When relocating to a different project area to work, take care in placing the rover rod with GNSS receiver in the vehicle to avoid damage.
- The moving parts and clamps of tripods, rover rods, and other equipment shall be oiled occasionally. Also, screws and bolts shall be checked periodically for tightness to assure rigidity.
- Level bubbles should be calibrated at a minimum of once a month, or more frequently if the pole is dropped.

5.1.6 Adjustments

All survey equipment, including hand levels, planimeters, rods, etc., should be checked at frequent intervals to assure accuracy. As a general rule, TDOT personnel should not attempt instrument repairs. However, competent and qualified personnel may perform minor repairs. Adjustments can be classified as field or shop adjustments. Shop adjustments are made at the time of manufacture or during shop repairs.

The person in charge of the survey crew and Instrument Person shall know how to make field adjustments on levels and other equipment. This includes peg testing the level, leveling bubbles, and centering cross hairs in the level. When field adjustments become necessary, refer to the manufacturer's instructions for testing and adjusting. Shop repairs or adjustments requiring expenditure of funds shall have prior approval by the Regional Survey Supervisor. Instruments may be tested for distance and angle measuring accuracies by occupying points of known location.

5.2 Consultants

Each consultant supporting TDOT surveying projects shall maintain a copy of the annual calibration performed by a certified technician of the equipment manufacturer for each of the following equipment (e.g., total stations, laser scanners, digital levels, GNSS sensors and field controls) being used for a TDOT project and shall maintain copies of these reports for a minimum of 12 months. Calibration reports shall be provided to TDOT project managers upon request.

Chapter 6. General Survey Information and Consultant Coordination

These guidelines have been established to aid the Consultant in understanding the expectations of the Tennessee Department of Transportation throughout the coordination process. All inquiries concerning the project shall be directed to the appropriate Regional Survey Supervisor.

6.1 Design Criteria and Standard Drawings Pertaining to Surveys

6.1.1 General

Design criteria for each type of road can be found in the TDOT Standard Roadway and Structure Drawings under the **Roadway Design Standards** heading on this site:

<https://www.tn.gov/content/tn/tdot/roadway-design/standard-drawings-library/standard-roadway-drawings.html>

When a design speed is given, it is considered a minimum. A lower design speed shall not be used without the consent of the Regional Survey Supervisor. The highest feasible design speed is desirable. However, the mixing of design speeds shall be avoided (produces unsafe conditions).

6.1.2 Alignment Criteria Given

Knowing the minimum design speed, the tables in the TDOT Standard Roadway and Structure Drawings will yield the required radius, spiral length of runoff, grades, sight distance, etc.

6.1.3 Design Criteria

The TPR will be given to the Field Office Supervisor before starting the survey and will provide the following information:

- Proposed typical section
- Design speed
- Current ADT and projected ADT
- General route location

Environmental Impact Statements (EIS) may contain items which shall be addressed during the survey.

The “TDOT Roadway Design Guidelines” have been developed as a reference for Road Design Engineers. Some of the sections directly affect the survey function and may be referenced in this survey manual.

6.2 Report and Correspondence

6.2.1 Survey Transmittal Letter

The letter is prepared by the Field Office Supervisor transmitting the survey to the Regional Survey Supervisor. The Regional Survey Supervisor uses it in transmitting the survey to the appropriate agency or office.

6.2.2 Survey Checklist

The check sheet is prepared by the Field Office Supervisor or Consulting Engineer, submitted to the Regional Survey Supervisor with each completed survey, and kept as part of the regional survey project file. Each survey shall be checked for completion by using the survey check sheet item by item. It is not required for additional information and updated surveys.

6.3 Field Books

6.3.1 General

The primary method of recording data for field surveys is the electronic data collector. However, field books are frequently used to supplement recorded data or for narrative information, e.g., record of discussions with property owners or utility company representatives. The front cover of each book shall be labeled with project number, county, survey route, project location (from and to), and book number. The pages of each book shall be numbered. Notes must be legible and written with clarity.

6.3.2 Benchmark Levels

Benchmark level notes are recorded in the field book and must be reduced and checked. ([Appendix C.8.1](#) and [Appendix C.8.2](#)).

6.3.3 Profile Notes

Usually, profiles are developed from the Digital Terrain Model. However, conventional profile runs are sometimes required by the Regional Survey Supervisor. An example of profile notes may be found in [Appendix C.8.4](#).

6.4 Horizontal and Vertical Measurements

6.4.1 Linear Measurement

Electronic distance measuring equipment shall be used whenever possible to obtain linear measurements. Total stations shall be used to measure the distances between P.O.T.'s or between P.I.'s on the centerline of a survey.

Horizontal distances are to be used in the preparation of maps and plans, in deed descriptions, and in centerline stationing.

6.4.2 Angular Measurement

A horizontal angle, such as a delta angle turned at a P.I., shall be turned in accordance with [Appendix C.7.1](#). A “position” is the act of making one direct and one reverse observation on each backsight and foresight point and averaging the angles.

Vertical angles shall be read in both direct and reverse positions of the scope, and the angles averaged.

For extending straight lines, “double-centering” of the transit or theodolite shall be used.

6.4.3 Vertical Measurement

When an engineer’s level and level rod are used, the turning points shall be “balanced”, and the level run tied to a known benchmark.

When an EDM is used, vertical angles shall be read in both direct and reverse positions of the scope, and angles averaged.

6.5 Coordination of Consultant Survey Projects

6.5.1 General

Consultant firms providing surveying services for the Department will be considered an extension of state forces and will be subject to controls and procedures specified within this manual. Exceptions to this policy will include some reporting procedures and specific exclusions stipulated in the contract or directed by the Regional Survey Supervisor or other appropriate Department representative. The Department has developed an estimate form using the computer software Microsoft® Excel. This current form will be used on all survey projects and on survey and design projects where applicable at the discretion of the Survey Coordinator.

6.5.2 Contacts

6.5.2.1 Contractual Matters

The Consultant shall contact the appropriate Civil Engineering Manager 2, Survey and Design on all matters pertaining to contract interpretation, billing procedures, payments, extensions to contracts, future projects, etc.

6.5.2.2 Work Related Matters

The Regional Survey Office shall be consulted on matters pertaining to scope of work, procedures, and requests for supplies and assistance.

6.5.3 Estimates

6.5.3.1 Contacts

The Consultant shall contact the Regional Survey Office to discuss scope of work, procedures, difficulty factors, etc. before an estimate for cost of services is prepared. The Regional Survey Office will provide TPRs, location sketches, etc. as required. It is recommended that a meeting at the jobsite or in the Regional Survey Office serve as this contact. In the case of extremely small or simple projects, phone contact may suffice. This contact will allow for negotiations on all activity difficulty factors as well as items entered on the project summary sheet.

6.5.3.2 Preparation

The proposal for services shall use the current Microsoft® Excel form for Survey and Design estimates. The **Manday Estimate Form** can be found under the **Standard Survey CADD Files and Documents >> Others** heading on this site:

<https://www.tn.gov/tdot/roadway-design/survey-standards/survey-cadd-files.html>

Proposals not submitted in this manner cannot be properly evaluated and may be deemed unacceptable. The form is designed to be used for most types of surveys; therefore, all items will probably not apply to a particular survey.

6.5.3.3 Department

A separate estimate of man-days required will be made by the Regional Survey Supervisor or the Survey Coordinator using the most recent version of the TDOT survey and design estimate form created in Microsoft® Excel. This estimate will be identical to the consultants, since the project data and difficulty have been negotiated.

6.5.3.4 Submittal

CONSULTANT: The “Manday Proposal” and any other supporting documents included in the proposal will be submitted to the Survey Coordinator.

DEPARTMENT: An “Estimate for Field Surveys” and a “Project Summary Form” are completed by the Regional Survey Manager and submitted to the Survey Coordinator.

6.5.4 Delivery Procedures

The following delivery procedures apply for all projects:

- Completed surveys will be submitted along with the completed survey checklists to the Regional Survey Office.
- In addition to the consultant’s review, the Regional Survey Office will review completed projects to assure that all required information is present and in acceptable format. In the event that additional information is required or other problems exist, necessary arrangements with the Consultant will be made by the Regional Survey Office.
- Upon successful completion of the survey, (all necessary information submitted and approved), the appropriate Civil Engineering Manager 2, Survey and Design shall be notified. This notification (in writing) shall indicate that the project is complete and additional comments made as to the quality of the product, cooperation and competency of the Consultant, and any other information pertinent to the project. The Survey Coordinator shall receive a copy of the letter.
- Submitting of the survey, after checking, will be according to usual procedures ([Section 9.2](#)).

Chapter 7. Remote Sensing

The intent of this chapter is to provide guidelines to help ensure proper and efficient use of remote sensing technologies in support of Tennessee Department of Transportation projects. The guidelines and/or specifications herein are not intended to be all encompassing or unnecessarily restrictive; nor are they intended to extend beyond the described remote sensing applications for general surveying use.

7.1 Terrestrial Scanning

Laser scanning or Light Detection And Ranging (**LiDAR**) systems use lasers to make measurements from a tripod or other stationary mount, a mobile mapping vehicle, or an aircraft. The term LiDAR is sometimes used interchangeably with laser scanning. Terrestrial LiDAR or Terrestrial Laser Scanning (**TLS**) as discussed in this chapter does not pertain to airborne LiDAR or Airborne Laser Scanning (ALS). Survey specifications describe the methods and procedures needed to attain a desired survey accuracy standard.

“Classifications of Accuracy and Standards.” TDOT survey specifications shall be used for all TDOT-involved transportation improvement projects, including special-funded projects.

7.1.1 Stationary Terrestrial Laser

Terrestrial Laser Scanning (TLS) refers to laser scanning applications that are performed from a static vantage point on the surface of the earth.

The raw data product of a laser scan survey is a point cloud. When the scanning control points are georeferenced to a known coordinate system, the entire point cloud can be oriented to the same coordinate system. All points within the point cloud have X, Y, and Z coordinates and Laser Return Intensity values (XYZI). The points may be in an XYZIRGB (X, Y, Z coordinates, return Intensity, and red, green, blue color values) if image overlay data is available. The positional error of any point in a point cloud is equal to the accumulation of the errors of the scanning control and errors in the individual point measurements or the registration process.

Just as with reflectorless total stations, laser scan measurements that are perpendicular to a surface will produce better accuracies than those with a large angle of incidence to the surface. The larger the incidence angle (Figure 6 in [Section 7.1.5.1](#)), the more the beam can elongate, producing errors in the distance returned. Data points will also become more widely spaced as distance from the scanner increases and less laser energy is returned. At a certain distance the error will exceed standards and beyond that no data will be returned. Atmospheric factors such as heat radiation, rain, dust, and fog will also limit a scanners effective range if it is a phase based or time-of-flight scanner.

7.1.2 TLS Application

Two types of Terrestrial Laser Scanning (TLS) specification groups have been described to differentiate between TLS surveys have varying accuracy, control, and range requirements. “Type A” TLS surveys are hard surface topographic surveys with data collected at engineering-level accuracy. “Type B” TLS surveys are topographic surveys with data collected at lower-level accuracy.

7.1.2.1 Type A – Hard Surface Topographic Surveys

- Pavement Analysis Scans
- Roadway/pavement topographic surveys
- Structures and bridge clearance surveys
- Engineering topographic surveys
- Detailed Archaeological surveys
- Architectural and Historical Preservation surveys
- Deformation and Monitoring surveys
- As-built surveys
- Forensic surveys

7.1.2.2 Type B – Earthwork and Lower-accuracy Topographic Surveys

- Corridor study and planning surveys
- Asset inventory and management surveys
- Environmental surveys
- Sight distance analysis surveys
- Earthwork surveys such as stockpiles, borrow pits, and landslides
- Urban mapping and modeling
- Coastal zone erosion analysis

7.1.3 TLS Project Selection

TLS equipment is available for State Highway System (SHS) project work. The following are factors to consider when planning use of TLS on a particular SHS project:

- Safety
- Project deliverables desired
- Project time constraints
- Site or structure complexity or detail required
- Length/size of project
- Traffic volumes and best available observation times

- Forecast weather and atmospheric conditions at planned observation time
- TLS system
- Availability
- Accuracy required
- Technology best suited to the project and desired final products

7.1.4 TLS Equipment and Use

All the equipment used to collect TLS data, to control the data, and to collect the quality control check / validation points should be able to collect the data at the accuracy standards required for the project. This determination will be from the stated specifications for the equipment by the manufacturer. TLS accessories include tripods, tribrachs, targets, and target poles. Tall tripods with dual-clamp lock on its legs are recommended for the scanner instrument. All survey equipment must be properly maintained and regularly checked for accuracy and proper function ([Section 5.1](#)).

Best practices to consider when choosing a scanning set-up location:

- Scanners go through a calibration process at startup. Strong wind or vibration can interfere with this process. Select set-up locations with low vibration and use during low wind conditions. Upon initial set-up, it is advised that the scanner be leveled prior to start up.
- When possible, select laser scanner set-up locations to minimize the exposure of the operator, members of the crew, and the laser scanner to danger. Select stable ground or footing for the tripod feet. Do not set a laser scanner directly in front of or behind a vehicle or piece of construction equipment that may suddenly move.
- If the laser scanner or any personnel are required to be in an area subject to traffic, follow protection procedures (reference TDOT standards here).

Precautions to take when operating a laser scanner include:

- Do not leave the scanner unprotected or unattended in unsecured areas.
- Clean the scan windows using the material provided from the manufacturer to prevent scratching the glass.
- Calibrate scanner per manufacturer's recommended procedures. It is advised to calibrate on an annual basis.
- Check the tribrach bubble level and centering error on a regular basis.
- Remove the scanner from the tripod when changing set-up locations.
- Use sandbags on the tripod or bipod legs to prevent the scanner or targets from being blown over by vehicle induced wind gusts or in windy conditions.
- Scanners can be operated at night, but not in conditions with particles or precipitation in the air. Plan project and set-up locations for safety.

- Snow, rain, blowing dust, smoke, and fog can cause problems when scanning. Operate the scanner in clear conditions for best results.

7.1.4.1 Eye Safety

Follow **OSHA 1926 Regulation.54** and manufacturers' recommendations when using any laser equipment. Never stare into the laser beam or view laser beams through magnifying optics, such as telescopes or binoculars. TLS equipment operators should never direct the laser toward personnel operating instruments with magnifying optics such as total stations or levels. Additionally, the eye safety of the traveling public and other people should be always considered and the equipment operated in a manner to ensure the eye safety of all.

7.1.4.2 Useful Range of Scanner

Since a laser is capable of scanning features over long distances, and since the accuracy of the scan data diminishes beyond a certain distance, care should be taken to ensure that the final dataset does not include any portion of point cloud data whose accuracy is compromised by measurements outside the useful range of the scanner. The useful range is influenced by factors such as the range and accuracy specifications of the individual scanner as well as the accuracy requirements of the final survey products. Methods for accomplishing this might include the implementation of range and/or intensity filtering during data collection or culling any out-of-useful range data during post-processing. Surface properties including color, albedo or surface reflectivity, surface texture, and angle of incidence can limit scanner useful range.

7.1.4.3 Scanner Targets

Total station targets reduce pointing error when placed at long distances. Laser scanning targets, however, are designed for a specific range of distance. Most laser scanners do not have telescopes to orient the instrument to a backsight. TLS targets must be scanned with a sufficient density to model their target reference locations. The size of the target, laser spot size, distance from the scanner, and target scan resolution determine how precisely the target reference locations can be determined. If the distance from the scanner to the target exceeds the manufacturer's recommended distance, the error may increase dramatically. Vendor-specific recommended targets may differ in size and shape. The operator should follow the manufacturer's recommended targets, distance for placement of targets, and target scan resolution.

Guidelines to properly maintain hard targets include:

- Transport and store targets separately in padded compartments, padded containers, or soft cases to prevent damage.
- Do not place or store targets where they might be damaged.
- All targets should be removed from target poles before being stored.
- Clean target surfaces regularly, using water and a soft towel.

7.1.5 TLS Specifications and Producers

TLS collected survey data points are checked by various means including:

1. Comparing the scan to the quality control check / validation points.
2. Reviewing the DTM and data terrain lines in the profile.
3. Redundant measurements. Redundant measurements with a laser scanning system can only be accomplished by multiple scans, either from the same set-up, or from a subsequent set-up that offers overlapping coverage.

Table 9 in [Section 7.1.6.2](#) lists the specifications required to achieve TLS general order accuracy.

7.1.5.1 Planning

Before the TLS project commences, the project area shall be examined to determine the best time to collect data to minimize excessive “artifacts” (or noise) from traffic or other factors, and to identify obstructions that may cause data voids or shadows. Check weather forecast for fog, rain, snow, fire smoke, or blowing dust. Tall tripod set-ups may be used to help reduce artifacts and obstructions from traffic and pedestrians, and to reduce incident angle (Figure 6). Some scanners have functions to filter out moving obstructions and minimize the effects of excessive incidence angle. Difficult scanning areas in the project should be identified and have a plan developed to minimize the effect on the final data, through additional set-ups or alternate methods of data collection. Safety should always be taken into consideration when selecting setup locations.

Site conditions should be considered to determine expected scanning distance limitations and required scan density to adequately model the subject area. Pavement analysis scans to identify issues such as surface irregularities and drainage problems require a scan point density of 0.10' or less (Figure 6). Some scanners can maintain a constant desired point density throughout their effective range. Pavement analysis scans also require shorter maximum scanning distances and closer spacing of scanner control and check / validation points than other Scan Type A applications.

FIGURE 6. SCAN POINT DENSITY FOR PAVEMENT PLANE SURVEYS

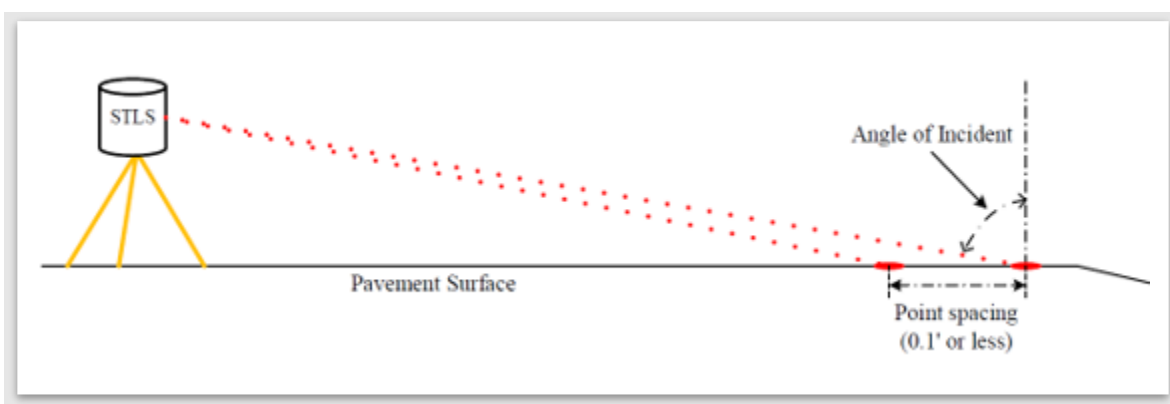

7.1.5.2 Project Control Establishment and Target Placement

When performing Type A TLS surveys, the TLS control (scanner occupation and targeted control stations) points that will be used to control the point-cloud adjustment and check / validation points that will be used to check the point-cloud adjustment of the TLS data. These check / validation points shall meet 0.07' local network accuracy or better horizontal and third order vertical accuracy standards. Best results are typically seen when the targeted control stations are evenly spaced horizontally throughout the scan. Variation in target elevations is also desirable. Targets should be placed at the recommended optimal distance from the scanner and scanned at high-density as recommended by the TLS manufacturer. Maximum scanner range and accuracy capabilities may limit effective scan coverage.

Pavement analysis survey scans to identify issues such as surface irregularities and drainage problems may require shorter maximum scanning distances and closer spacing of scanner control and check / validation points than other Scan Type A applications (Figure 7).

All Type A, hard surface topographic TLS surveys require control meet the 0.07' local network accuracy and third order vertical accuracy, and check / validation point surveyed local positional accuracies of X, Y, (horizontal) $\leq 0.03'$ & Z (vertical) $\leq 0.02'$ through the registration process. Scan Type B, earthwork and other lower-accuracy topographic surveys require check / validation point surveyed local positional accuracies of X, Y, & Z $\leq 0.10'$ through the registration process (Table 9 in [Section 7.1.6.2](#)). All TLS control and check / validation points shall be on the project datum and epoch.

FIGURE 7. TARGET PLACEMENT AND SCAN COVERAGE - OTHER SCAN TYPE A APPLICATIONS

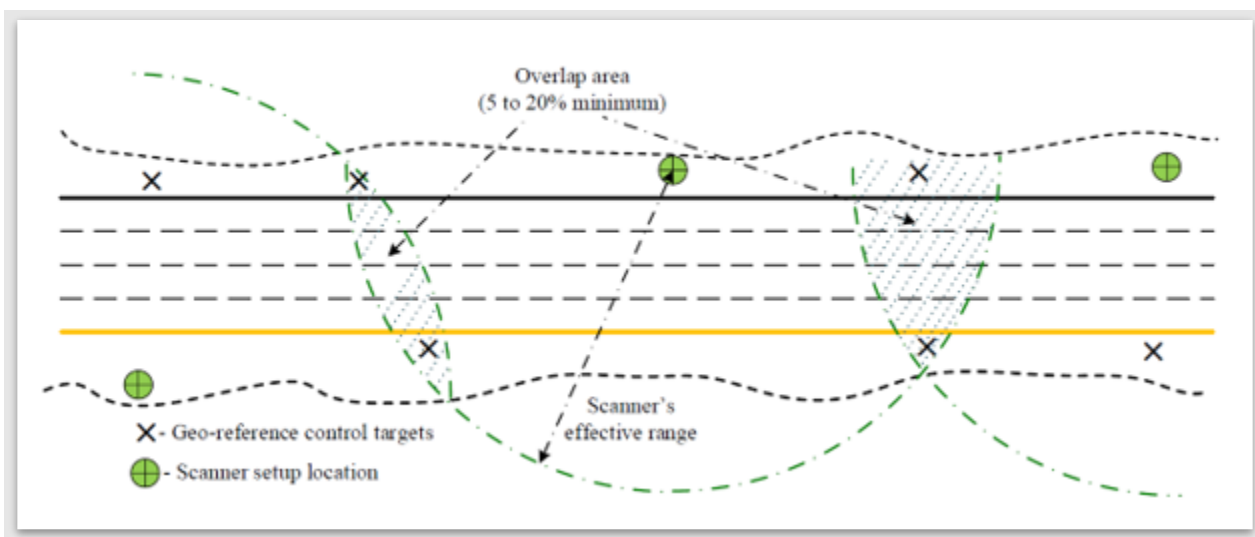

Note: Fewer targets may be required. Care must be taken not to exceed other limitations.

7.1.5.3 Equipment Set-up and Calibration

When occupying a known control point, ensure the instrument is over the point, measure and record the height of instrument (if required) and height of targets (if required) at the beginning of each set-up. It is advisable to check the plummet position for targets at the completion of each set-up. Scanners that do not have the ability to occupy known points require additional targets to control each scan and establish scanner position by resection. These targets should be distributed throughout the scanning route and remain in view of the scanner through multiple set-ups. Setting up the laser scanner as high as practicable on a tall tripod would reduce the angle of incidence and consequently improve the scanner's effective range and accuracy points on the pavement surface. Ensure automatic TLS system calibration routines are functioning per the manufacturer's specifications.

7.1.5.4 Redundancy

TLS data collection shall be conducted in such a manner as to ensure redundancy of the data through overlapping scans. The data should be collected so that there is a minimum 5% to 20% overlap (percentage of scanner's useful range) from one scan to the next adjacent scan. When using cloud to cloud registration overlap can be as much as 75%.

7.1.5.5 Monitoring TLS Operation

Monitoring TLS operation during the scan session is an important step in the scanning process. The system operator should note if and when the TLS system encountered difficulty and be prepared to take appropriate action to ensure data quality.

7.1.5.6 Quality Control

Engineering survey data points collected using TLS data are checked by various means including comparing scan points to check / validation points, reviewing the digital terrain model, reviewing data terrain lines in plan and profile, and redundant measurements. Redundant measurements with TLS can only be accomplished by scanner set-ups that offer overlapping coverage. Plan and profile views of overlapping registered point clouds should indicate precise alignment and data density of less than 0.03 ft vertical at scan seams. Elevation comparison may be performed using profile, Digital Elevation Model (DEM) differences determined from point grid or Triangular Interpolation Network (TIN) data.

A TLS Quality Management Plan (QMP) shall include descriptions of the proposed quality control (QC) and quality assurance (QA) plan. The QMP shall address the requirements set forth in this document and any other project-specific QA/QC measures.

The QA/QC report shall list the results of the TLS including but not limited to the following documentation:

1. Project Control reports.
2. TLS registration reports that contain registration errors reported from the registration software.
3. Elevation comparisons of two or more point clouds from overlapping scan area (Table 9 in [Section 7.1.6.2](#)). This can be in the form of a point cloud deviation map ([Appendix C.18](#)).
4. Statistical comparison of point cloud data and redundant control point(s) if available.
5. Statistical comparison of registered point cloud data with check / validation points from conventional surveys if available.

Either item 4 or 5 shall be performed for QC. Completing both item 4 and 5 is highly recommended.

7.1.6 TLS Deliverables and Documentation

The desired deliverables from a scanning project should be identified in the planning stage. The ultimate value of the TLS collected data is multiplied when it is “mined” for data for various uses and customers beyond its initial intended use.

7.1.6.1 TLS Deliverables

Different projects and customers require different types of deliverables, which can range from a standard CADD product to a physical three-dimensional (3D) scale model of the actual subject.

Deliverables specific to TLS surveys may include, but are not limited to:

- Registered point clouds in XYZI or XYZIRGB files in ASCII, CSV, LAS, LAZ, ASTM E57 3D Imaging Data Exchange Format (E2761), or other manufacturer’s specified format
- Digital image mosaic files
- 3D printing technology physical scale models of the subject
- Survey narrative report and QA/QC files

7.1.6.2 TLS Documentation

Documentation of surveys is an essential part of surveying work. 3D data not properly documented is susceptible to imbedded mistakes and is difficult to adjust or modify to reflect changes in control. An additional concern is that poorly documented data may not be legally supportable.

The survey narrative report, completed by the person in responsible charge of the survey (typically the Party Chief), shall contain the following general information, the specific information required by each survey method, and any appropriate supplemental info.

- Project name and identification: County, Route, Postmile, E.A. or Project Identification, etc.
- Survey date, limits, and purpose
- Datum, epoch, and units
- Control found, held, and set for the survey
- Personnel, equipment, and surveying methods used
- Field notes including scan diagrams, control geometry, instrument and target heights, atmospheric conditions, etc.
- Problems encountered
- Any other pertinent information
- TLS and MLS checklists to be submitted with manday estimate ([Appendix C.17.1](#) and [Appendix C.17.2](#))
- QA/QC reports ([Appendix C.17.1](#), [Appendix C.17.2](#), [Appendix C.18](#), and [Appendix C.19](#))
- Dated signature of the Party Chief or other person in responsible charge

TABLE 9. STATIONARY TERRESTRIAL LASER SCANNING SPECIFICATIONS

Operation / Specification	TLS Scan Application	
	Scan Type A	Scan Type B
Level compensator should be turned ON unless unusual situations require that it be turned OFF	Each set-up	
Minimum number of targeted control points required	Follow manufacturer’s recommendations. Recommended 3 targets from scan to scan.	
TLS control and check / validation point surveyed positional local accuracy	H ≤ 0.03 foot V ≤ 0.02 foot	H and V ≤ 0.10 foot
Strength of figure: α is the angle between each pair of adjacent control targets measured from the scanner position	Recommended 60° ≤ α ≤ 120°	Recommended 40° ≤ α ≤ 140°

Operation / Specification	TLS Scan Application	
	Scan Type A	Scan Type B
Target placed at optimal distance to produce desired results	Each set-up	
Control targets scanned at density recommended by vendor	Required	
Measure instrument height and target heights	If required	
Fixed height targets	Recommended	
Check plummet position of instrument and targets over occupied control points	Begin and end of each set-up	
Be aware of equipment limitations when used in rain, fog, snow, smoke or blowing dust, or on wet pavement	Each set-up	
Distance to object scanned not to exceed best practices for laser scanner and conditions -Equipment dependent	Manufacturer's specification	
Distance to object scanned not to exceed scanner capabilities to achieve required accuracy and point density	Each set-up	
Observation point density	Sufficient density for feature extraction	
Overlapping adjacent scans (percentage of scan distance)	5% to 20%	
Registration of multiple scans in post-processing	Required	
Post-processing software registration error report	Required	
Registration errors not to exceed in any horizontal dimension	0.03 foot	0.15 foot
Registration errors not to exceed in vertical dimension	0.02 foot	0.10 foot
Independent check / validation points from conventional survey to confirm registration	Minimum of three (3) per mile	Minimum of two (2) per mile

7.2 Mobile Mapping and Scanning

Mobile LiDAR System (**MLS**) uses laser scanner(s) in combination with Global Navigation Satellite System (GNSS) receivers, Inertial Measurement Unit (IMU), and Distance Measuring Instrument (DMI) to produce accurate and precise geospatial data from a moving terrestrial platform.

LiDAR sensors use an active (projected) light signal to measure the x, y, and z position and reflective properties of a point on an object. In practice this results in a point cloud with image qualities similar to other remote sensing technologies. This allows the value of a point cloud to be extended when it is mined for topographic features and information beyond what was required of the intended survey. However, the origin and accuracy of the point cloud data must be supported by a signed survey report for it to be used with confidence and to ensure the survey information with any byproducts are not misused.

The accuracy of the point cloud data diminishes as the distance from the LiDAR sensor increases. The effective range of the LiDAR sensor, for purposes of this document, is determined by the sensor manufacturer specifications of precision as they relate to the accuracy requirements of the project or specific areas of the project. Care should be taken to ensure that the effective range of the scanner meets the needs for the particular applications of the specified project. Points collected outside the effective range of the scanner shall be filtered out during data collection or by distinguishing them from valid project data by classifying them as erroneous after processing.

Point density is primarily determined by the measurement rate (combination of mirror speed and pulse rate) of the sensor along with the speed of the sensor platform during measurement. The point density should be sufficient to identify and extract physical detail to the accuracy specified for the project and must exceed 30 points per square foot per acquisition line at posted highway speed.

The focus of this document is on three major application categories of MLS. The examples provided above are not intended to be exhaustive as technology is rapidly evolving.

7.2.1 Type A – High Accuracy Surveys

- Design Engineering topographic
- As-built
- Structures and bridge clearance
- Accident site surveys
- Deformation surveys

7.2.2 Type B – Medium Accuracy Surveys

- Design Engineering topographic Corridor Study/Planning
- Detailed Asset inventory and management surveys

- Environmental
- Earthwork
- Urban mapping and modeling Coastal zone erosion analysis

7.2.3 Type C – Lower Accuracy Mapping

- Preliminary Planning
- Transportation Statistics
- General Asset inventory surveys

7.2.4 MLS Project Selection

The following are some of the key factors to consider when determining if MLS is appropriate for a particular survey project:

- Safety
- Project deliverables desired
- Budget
- Project time constraints
- GNSS data collection environment
- Terrain and length/size of project
- Traffic volumes and available observation times

7.2.5 MLS Equipment

All the equipment in the MLS system used to collect, process, and adjust data must be of sufficient precision to meet the accuracy requirements of the project and applicable accuracy standards described in this document. This determination can be made from the stated specifications of the equipment by the manufacturers, analysis of the systems performance on projects with similar requirements, and the expert opinion of the Professional Land Surveyor in responsible charge of the project survey data and supporting Survey Report.

7.2.5.1 Minimum MLS System Sensor Components

- LiDAR sensor
 - a) Follow OSHA Regulations 1926.54 and manufacturers recommendations when using any laser equipment. Never stare into the laser beam or view laser beams through magnifying optics, such as telescopes or binoculars. Additionally, the eye safety of the traveling public and other people should be considered at all times and the equipment operated in a way to ensure the eye safety of all.

- GNSS receivers
 - a) Minimum of one onboard (roving) Global Navigation Satellite System (GNSS) dual frequency receiver capable of producing real-time kinematic (RTK) data that can be downloaded and post processed
 - b) One or more Static GNSS dual frequency receiver(s) at Base Station(s) capable of simultaneous collection set at one second epoch and storage of real-time kinematic (RTK) data that can be post processed.
- An Inertial Measurement Unit (IMU)
- A Distance Measuring Instrument (DMI)
- An integrated camera system capable of collecting imagery during the collection of the LiDAR data. The quality of the camera system should allow the acquisition of imagery at LiDAR collection speeds without image blur and be utilized to add RGB values to create a colorized LiDAR dataset.

The collection rate (epoch) of all MLS systems sensors must be sufficient to meet project accuracy and point density requirements.

7.2.6 MLS Project Specifications and Procedures

7.2.6.1 MLS Mission

To maximize the quality and production of measurements, mission planning should be conducted before the collection of MLS project data commences.

During a MLS data collection mission, simultaneous GNSS signals from a minimum constellation of 5 satellites should be maintained between at least one GNSS Base Station receiver, and the GNSS roving receiver(s). The GNSS constellation PDOP should be 5 or less at the base and roving units during data acquisition. The occasional momentary loss of GNSS signals, also known as cycle slips, may occur. In these cases, the position of the LiDAR sensor is dependent on the IMU/DMI and degrades quickly over time from the last corrected GNSS position. To avoid poor and erroneous measurements the period of lost GNSS corrections should never exceed the IMU's ability to accurately position the sensor over this time interval.

Erroneous measurements can be caused by other factors besides a degraded sensor position. The inadvertent scanning of moving targets such as traffic or pedestrians may adversely affect measurements. Additionally, the texture, shape, and color of the surface being scanned may also affect measurements and add unwanted data anomalies.

Projects with difficult MLS survey conditions should be examined first to identify as many of these variables as possible and develop a plan to mitigate their effect on the data. Usually this will require additional control to ensure the MLS measurements in these areas meet the project accuracy requirements.

7.2.6.2 Project Base Station Control Establishment

The project base station control that will be used to post-process the MLS GNSS data shall be placed at intervals that ensure that no processed baseline exceeds the survey type requirements listed in Table 10 in [Section 7.2.6.6](#). Short baselines contribute to the best possible positional accuracy. Short baselines are recommended to guard against the possibility of wasted effort and anomalies in the data from base station failure due to equipment or human errors in station setup. Base station(s) should be located along the corridor to meet the baseline length limitations listed in Table 10 in [Section 7.2.6.6](#) for the project area to be mapped. The limitation does not apply to data collected outside of the project as often happens during vehicle staging at the beginning and ending of each pass. The project base station control shall conform to Location & Surveys Guidelines on the usage of GNSS.

7.2.6.3 Equipment Maintenance and Bore Sight Calibration

All of the sensor equipment in the MLS system shall have records documenting maintenance to the manufacturer's recommendation, including all repairs and adjustments to the sensors.

Sensor alignment (bore sighting) procedures sufficient to meet project accuracy requirements shall be performed and documented for each project.

7.2.6.4 Redundancy

MLS data collection shall be conducted in such a manner as to ensure redundancy of the data. This means that more than one scan pass is necessary. The data shall be collected so that there is overlap between scan passes. The minimum amount of overlap along the sides of the scan passes should be sufficient to allow for filling of data voids between passes, QA/QC comparisons between passes and a homogenized point cloud. More overlap is often necessary to cover critical areas where high accuracy surfaces are needed. The redundant passes can be made in the same direction or in opposite directions.

7.2.6.5 Monitoring Data Collection

Monitoring various component operations during the scan session is an important step in the QA/QC process. The following is a list of items that should be monitored and documented during MLS data collection at a minimum.

- Loss of GNSS reception
- Uncorrected IMU drift both in distance and time
- Proper functioning of the laser scanner
- Vehicle speed

The system operator should be aware and note when the system encountered the most difficulty and be prepared to take the appropriate action in adverse circumstances.

7.2.6.6 Project Control – Local Transformation and Check / Validation Points

All MLS projects must be related to established project control, i.e., localized grid or TN State Plane Coordinate System, per TDOT project contract.

To increase the accuracy of the collected MLS geospatial data, a local transformation of the point clouds shall be conducted for MLS Types A and B. There are many different types of local transformation that may be employed, however, the most common is a least squares adjustment of the horizontal and vertical residuals between established Local Transformation (adjustment) Points and the corresponding values from the point clouds to produce the transportation parameters of translation, rotation, and scale for the horizontal values and an inclined plane for the vertical values. These parameters are then applied to the point cloud to produce more accurate final geospatial data within the localized area of control.

Targets occupying known horizontal and vertical control incorporated in MLS surveys shall serve as known local transformation points for point cloud adjustment and check / validation points for QA/QC. Targets must be of sufficient size and reflectivity to ensure redundancy of scan points to allow sufficient target identification and correct measurement within the point cloud.

The local transformation points shall be located at the beginning, end, and evenly spaced throughout the project to ensure that the project MLS collection area is bracketed. Local transformation points should be located in areas where scan runs intersect or overlap and at the outboard side of any overhead obstruction. They should be located immediately following a bridge or overhead sign at a distance away from the structure to ensure the structure does not interfere with the location of the point using VRS and RTK. The maximum distance with respect to route centerline stationing spacing between these points shall be based on the type of survey (Figure 8 on next page).

Check / validation points are used to check the geospatial data adjustment to the Local Transformation Points. Check / validation points shall be located at the beginning, end, and evenly spaced throughout the project. The maximum distance with respect to route centerline stationing spacing between these points shall be based on the type of survey (Figure 8 on next page).

FIGURE 8. TYPICAL MLS TYPE "A" LOCAL TRANSFORMATION AND VALIDATION POINT LAYOUTS

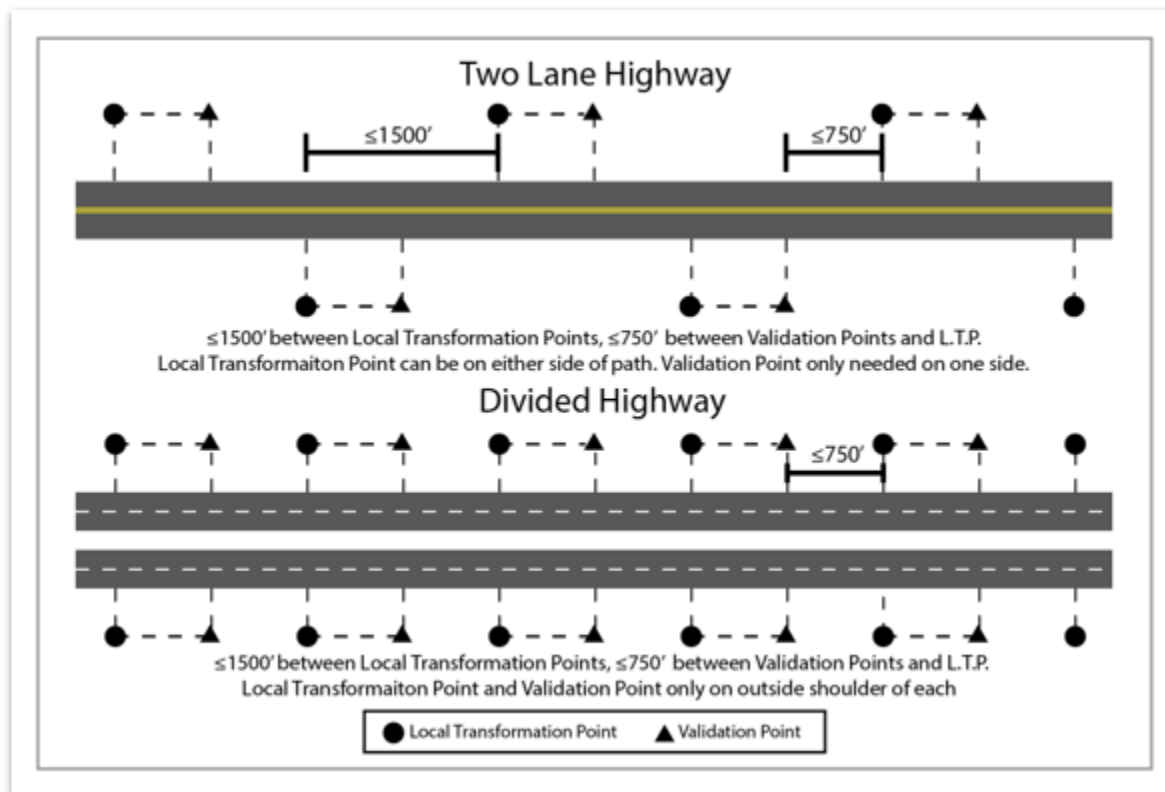

Note: Above layouts do not account for all MLS control scenarios. MLS control layouts for each individual project shall be submitted to the TDOT Regional Survey Coordinator for review prior to scoping.

TABLE 10. MLS APPLICATIONS

Operation / Specification	MLS Applications		
	MLS Type A	MLS Type B	MLS Type C
Bore sight calibration of MLS system per manufacturer's specifications before and after data collection adds cost and is not practical	Required		
Dual frequency GNSS	Required: See Note 6		
Inertial Measurement Unit	Required: See Note 6		
Distance Measuring Instrument	Required: See Note 6		
GNSS positioning should be constrained to local project control	Yes, not for C		
Minimum horizontal (H) and vertical (V) accuracies for GNSS control base stations	Must meet surpass MLS accuracy requirements of the project		

Operation / Specification	MLS Applications		
	MLS Type A	MLS Type B	MLS Type C
Minimum accuracy of local transformation points and check / validation points	H ≤ 0.07' V ≤ 0.05'	H ≤ 0.12' V ≤ 0.10'	H and V See Note 5
Maximum post-processed baseline length	7 miles	10 miles	20 miles
GNSS base stations located to minimize baseline lengths	Required A B Recommended C		
Minimum number of common healthy satellites in view for GNSS base stations and mobile scanner	See Notes 1 thru 5		
Sustained Maximum PDOP during MLS data acquisition	5		
Overlapping coverage between adjacent runs	Required		
Minimum orbit ephemeris for kinetic post-processing	Broadcast		
Observations – Sufficient point density to model objects	Each pass		
Vehicle speed – posted speed limits	Each pass		
Minimum number of local transformation points required	As Scoped	As Scoped	As Scoped
Local transformation point maximum spacing throughout project on either side of scanned roadway	1500' interval	3000' interval	See Note 5
Check / validation point maximum spacing throughout project on either side of scanned roadway for QA purposes as safety conditions permit (see Note 3)	750' interval	1500' interval	N/A
Minimum NSSDA Horizontal and Vertical Check Points	20 (See Note 7) As needed for Type C		

Notes:

1. Areas in the project that have poor satellite visibility should be identified and a plan to minimize the effect on the data developed.
2. If necessary, project area shall be reconnoitered to determine the best time to collect the data to minimize GNSS outages and excessive artifacts in the data collection from surrounding traffic or other factors.
3. If safety conditions permit, additional check / validation points should be added in challenging GNSS environment such as near structures, and overhead obstructions where GNSS visibility is poor.

4. GNSS coverage of less than 5 satellites in view must not exceed the uncorrected position time or distance traveled capabilities of the MLS system IMU.
5. Sufficient for data collected by MLS system to meet or surpass accuracy requirement of the project.
6. Manufacturer's specifications for precision must be sufficient for MLS system to meet or surpass accuracy requirements of the projects.
7. Check / validation points may serve as NSSDA check points to meet the requirements of this section. However, if critical areas of the point cloud are to be used outside of the locations of the validation points, the additional check points will be needed in those areas to meet this requirement.

7.2.6.7 National Standard for Spatial Data Accuracy (NSSDA)

The accuracy analysis of MLS point cloud data shall conform to the NSSDA requirements for geospatial data classifications as published by the FGDC in document FGDC-STF-007.3-1998 titled Geospatial Positioning Accuracy Standards Part 3: National Standard for Data Accuracy.

<http://www.fgdc.gov/standards/projects/FGDC-standards-projects/accuracy/part3/chapter3>

A minimum of 20 independent horizontal and vertical check points shall be measured and distributed to reflect the geographic area of interest and expected distribution of error in the data sets. The resulting comparisons shall meet or surpass the positional accuracy requirements for the survey at the 95% confidence level based on the NSSDA and shall be included in the Survey Report.

7.2.6.8 Quality Management Plan (QMP)

Engineering design survey data points collected using MLS are checked by various means including comparing scan points to check / validation points, reviewing the digital terrain model, reviewing independent cross section data to scan surfaces, and redundant measurements. Redundant measurements with MLS can only be accomplished by multiple scan runs or passes that offer overlapping coverage.

The MLS data provider shall provide a quality management plan (**QMP**) that includes descriptions of the proposed quality control and quality assurance plan. The QMP shall address the requirements set forth in this document as well as other project specific QA/QC measures.

7.2.7 MLS Deliverables and Documentation

As stated earlier the origin and accuracy of the point cloud data must be supported by a survey report for it to be used with confidence, and to ensure the survey information and any byproducts are not misused.

Documentation of project MLS survey(s) is an essential part of survey work. The documentation of a scanning project must show a clear data lineage from the published primary control to the final deliverables. Aa project deliverables and documentation shall be included or clearly identified by reference in the survey report.

7.2.7.1 All MLS Type Deliverables

The first product deliverable is an original post-processed, geo-referenced, classified point cloud in a digital LAS specific binary format file and applies to all MLS Type surveys.

Supporting documentation required but not limited to (**Note:** Consultants may be, at any time, required to provide this supporting documentation):

- Statistical system reports
- PDOP values during the survey
- Separation of forward and reverse solution of SBET (difference between forward and reverse post-process roll, pitch, yaw and XYZ positions solution)
- Areas of the project the data collected exceeded the maximum elapsed time or distance traveled of uncorrected IMU drift due to GNSS signals loss or obstruction (graphically or in text format)
- Comparison of elevation data form overlapping (side lap) runs in graphical cross section format or other text format that reports the data at specified intervals for each project scope
- Comparison of points at the area of overlap (end lap) if more than one GNSS base is used
- RMSE (Root-mean-square error) report ([Appendix C.19](#))
- OpenRoads Designer .DGN or GOOGLE EARTH .KMZ format file showing control points, base station locations, QA/QC points, projects limits and scan drivelines
- MLS trajectory paths of the vehicle

7.2.7.2 MLS Type A and B Deliverables Upon Request

The LAS file deliverable for MLS files A and B is the result of a transformed/adjusted point cloud.

The next form of the MLS point cloud data is the transformed/adjusted point cloud image also saved in an LAS specific binary format.

Supporting documentation required but not limited to:

- Statistical comparison of point cloud data and finished products to check / validation points
- Statistical comparison of adjusted point cloud data and redundant check / validation points

The developed MLS point cloud data is the transformed/adjusted and classified by specific point attribute(s) cloud image saved in an LAS specific binary format. A classified point cloud has the added value of having the individual points within it identified by class. The classes should be specified in the contract scope and be ASPRS standard class codes (Table 11 on next page). It is also important to identify the amount of classification necessary in the scope documents as this can be costly and time consuming.

Point cloud data can be imported into various software packages. Further data manipulation and/or fusing other types of data and analytical tools with the imported point cloud create a variety of value-added products.

The following digital products related to MLS surveys that are applicable to the project include:

- Binary LAS files of point cloud data from original scans
- Binary LAS files of adjusted point cloud data
- Binary LAS files of adjusted and classified point cloud data
- Digital video or image mosaic files
- FGDC compliant metadata files

Additional digital CADD products

- DTM Files, showing:
 - 2.5' grid of points
 - Breaklines on edges of pavement and travel ways ([Appendix C.16.1](#) and [Appendix C.16.2](#))
- Topographic Design Fields, if requested
- Other files as requested on a project basis

The project digital products shall be submitted to the Department on the portable external USB or fire wire computer drive accompanied by an itemized transmittal letter. All digital products submitted, along with any digital media drive shall be labeled on the outside with the following information:

- Project Title
- Survey Report Title
- Date of Survey
- RLS Number
- Consultant Name
- Name of Consultant Surveyor in Charge

TABLE 11. ASPRS STANDARD LIDAR POINT CLASSES

Classification Value	Classification Name
0	Created, never classified
1	Unclassified
2	Ground
3	Low Vegetation
4	Medium Vegetation
5	High Vegetation
6	Building
7	Low Point (noise)
8	Reserved
9	Water
10	Rail
11	Road Surface
12	Reserved
13	Wire – Guard
14	Wire – Conductor
15	Transmission Tower
16	Wire-structure Connector
17	Bridge Deck
18	High Noise

7.2.7.3 MLS Survey Report

The documentation of a mobile scanning project must show clear data lineage from the published primary control to the final deliverables. The data path of the entire process must be defined, documented, assessable, and allow for identifying adjustment or modification. 3D data without documented lineage is susceptible to imbedded mistakes, difficult to validate, and offers little or no reliability.

General Survey Report Content:

- Project name & identification: County, route, section, etc.
- Survey date, limits, and purpose
- MLS collection times
- Datum, epoch, and units
- Control found, held, and set for the survey
- Personnel, equipment, and surveying methods used
- Problems encountered
- Declare what MLS Type A, B, or C accuracy was achieved
- Project base stations occupied, accompanied by collection times
- Identification of control target points (transformation and check / validation)
- Results of constrained adjustment of MLS data to local transformation control points
- RMSE (Root-mean-square error) report ([Appendix C.19](#))
- All MLS Surveying and Mapping products submitted shall be supported by a Survey Report containing at a minimum all information necessary to support the precision and accuracy of MLS measurement and products and meets 21 NCAC 56.1602-1607 "Surveying Procedures". To this end the Survey Report shall include but is not limited to the documentation and references to digital reports, products, and media, identified in this document.

7.3 UAS Aerial Mapping

The use of small Unmanned Aircraft Systems (**UAS**) in the mapping marketplace has become prevalent since the FAA introduced the Part 107 regulations in 2016. These regulations have made the use of UAS in the commercial marketplace much more accessible to the surveying and mapping community. There is a large variety of UAS platform configurations including but not limited to: Multi-Rotor, Fixed Wing, and Fixed Wing Vertical Take-off and Landing (VTOL). Most platforms are battery operated with less than an hour of flight time, but hybrid propulsion systems can offer increased flight longevity. All aerial flights that are conducted using UAS shall comply with the standards established by the Federal Aviation Administration (FAA) and [TDOT UAS Standard Operating Guidelines](#) and TDOT Policy 170-03. UAS flights shall comply with the requirements outlined in Title 14 of the Code of Federal Regulations (14 CFR) Part 107, small Unmanned Aircraft Systems. Any deviation from these regulations shall require authorization or a waiver from the FAA.

At a minimum, a UAS crew shall consist of two persons: The Pilot in Command (PIC) and the Visual Observer (VO). When operating in airspace other than Class G, the PIC and VO should monitor air traffic through realtime flight tracking software as well as via a handheld aviation radio tuned to the correct common traffic advisory frequency (CTAF). If UAS flight approval via LAANC (Low Altitude Authorization and Notification Capability) is required for the flight area, proof of authorization and completion must be provided with the project deliverables. If the PIC experiences an issue with the UAS and an incident form must be reported to the FAA under regulation 14 CFR 107.9, this information must also be given to the TDOT Regional Survey Coordinator and the UAS Program Manager. Pre-flight responsibilities include but are not limited to:

- Check airspace and weather conditions
- Inspect the airframe and propulsion system to ensure airworthiness
- Maintain manufacture recommended maintenance and refrain from flying if software issues arise

Like all survey equipment there is a difference between consumer and professional grade technology, but this is very evident within the UAS market. Entry level UAS hardware typically records low accuracy GNSS locations with inaccurate vertical data, while systems with Real Time Kinematics (RTK) or Post Processing Kinematics (PPK) can precisely record the sensors position. When high accuracy GNSS is paired with a quality IMU, the number of ground control points (GCP's) can be reduced as the orthophotography or LiDAR data is inherently correct relative to its acquired GRID position. GCP's and check / validation points are still necessary to ensure project accuracy, but products derived from RTK or PPK systems are typically of higher accuracy within and outside of the control network.

UAS Photogrammetry and LiDAR can create detailed colorized point clouds and orthomosaics but often file sizes of deliverables can exceed that of what is expected or manageable. Deliverables specific to UAS may include, but are not limited to:

- Colorized and/or registered point clouds in LAS specific binary format that meets the ASPRS standard class codes. A classified point cloud has the added value of having the individual points within it identified by class. The classes should be specified in the contract scope and be standardized such as “Ground”, “Low Vegetation”, “High Vegetation” “Building”, “Erroneous Points”, etc. (Table 11 in [Section 7.2.7.3](#)).
- Orthophotography to be delivered as a MrSID (MicroStation compatible format) image with the associated world file. A MrSID image with a 1:20 image compression ratio, or greater, is suggested to reduce the overall file size without degrading the image quality.
- DTM Surface or planimetric files derived from UAS data should match that of what is recommended in [Section 4.1](#).

7.3.1 UAS Photogrammetry

The use of UAS to acquire low altitude nadir and oblique imagery can aid in project management and generation of survey deliverables. Georeferenced orthophotography and colorized point clouds can be created through Structure from motion (SfM) software that utilizes high overlap imagery. SfM can process imagery acquired from any camera and many software companies offer cloud based or local desktop processing options. To create products deemed applicable to meet accuracy standards required for the project, acquisition methods and equipment must meet the criteria's described below.

Best practices to consider when acquiring UAS aerial imagery:

- Imagery acquired in good lighting conditions and recommended to not be within two hours of sunrise or sunset to limit elongated shadows.
- Wind conditions should be adequate to get proper data collection and maintain safety standards.
- Orthophotography datasets should be captured with the camera angle fixed in the nadir location.
- Cameras must have a fixed focal length, no zoom or fisheye lenses.
- When possible, use a global shutter, rolling shutters can produce inferior images.
- Imagery collected to be processed through SfM should be at least 70% forward overlap (in the direction of the flight line) and 70% side overlap.

A minimum of five ground control points, with two photo ID or check / validation points per GCP are required. A few examples of a GCP target is shown in Figure 9. When setting control for linear segments, the GCPs should be distributed approximately 100ft off the centerline on alternating sides of the corridor, with 600ft – 800ft spacing between GCP's. Figure 10 Figure 11s (Figure 10 on next page) if there is a significant elevation change (e.g., high and low points, for areas of significant elevation change) (Figure 11 on next page). These methods can be scaled up to accommodate projects larger in size. To validate horizontal and vertical accuracy additional validation/check points (minimum of 2 per control point) shall be surveyed and compared with the orthophoto, DTM, or point cloud.

FIGURE 9. GROUND CONTROL POINT DISTRIBUTION - PLAN, LEFT SITE PLAN, RIGHT LINEAR PLAN

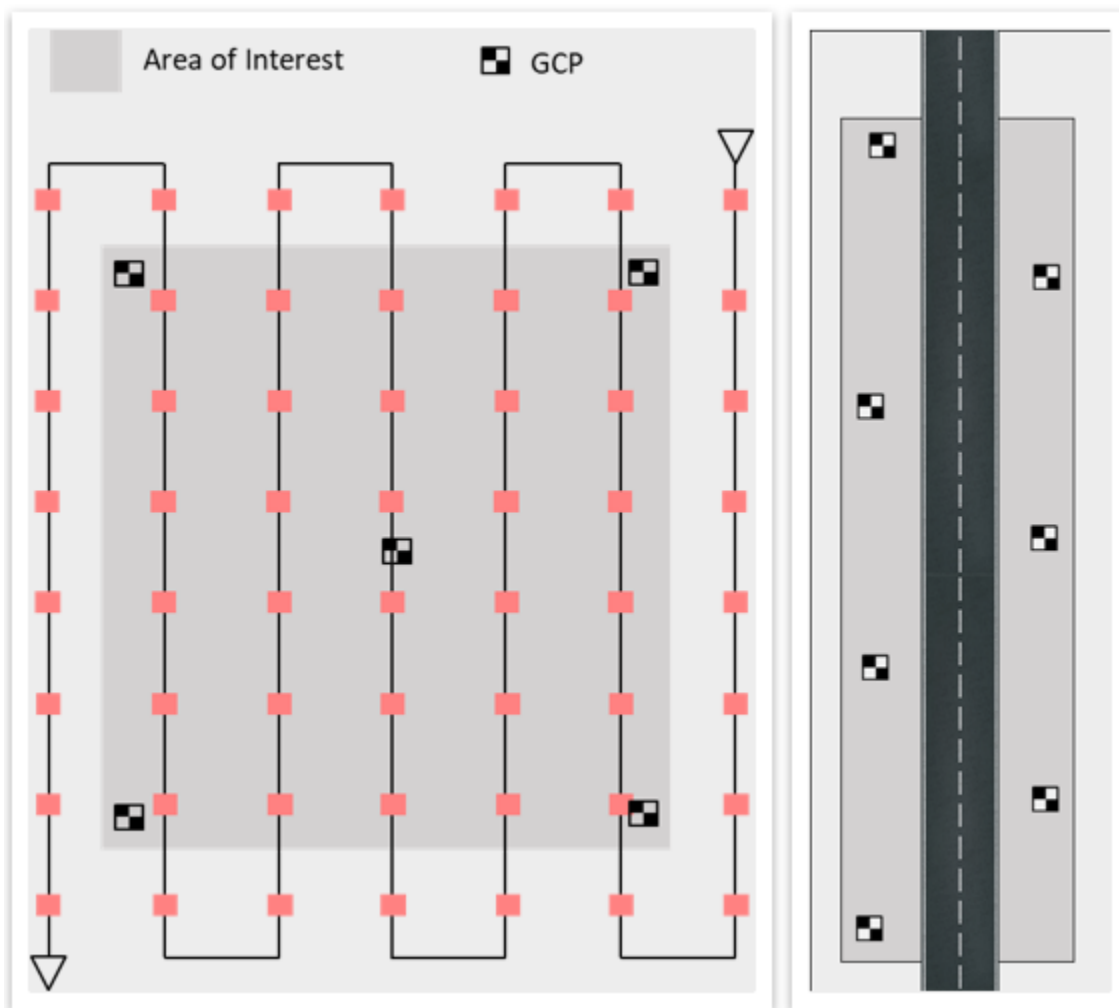

FIGURE 10. SURFACE WARPING FROM GCP PLACEMENT

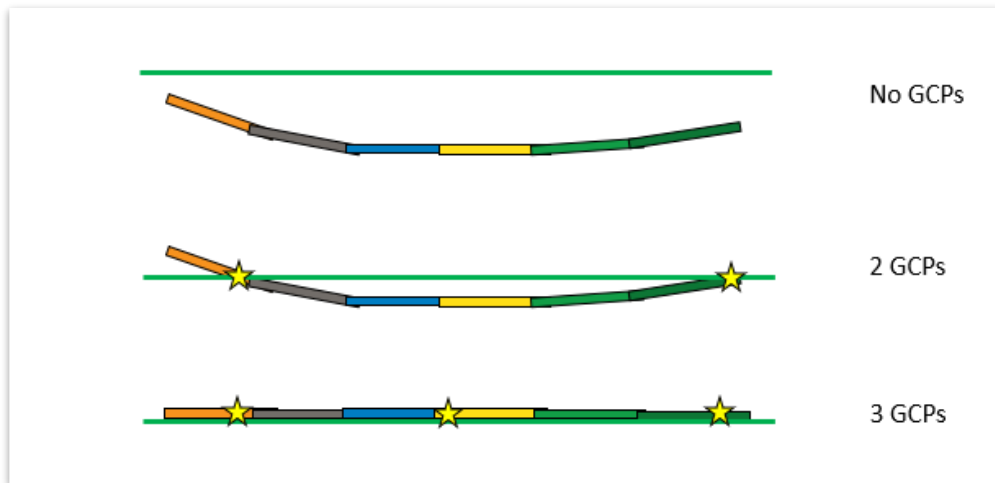
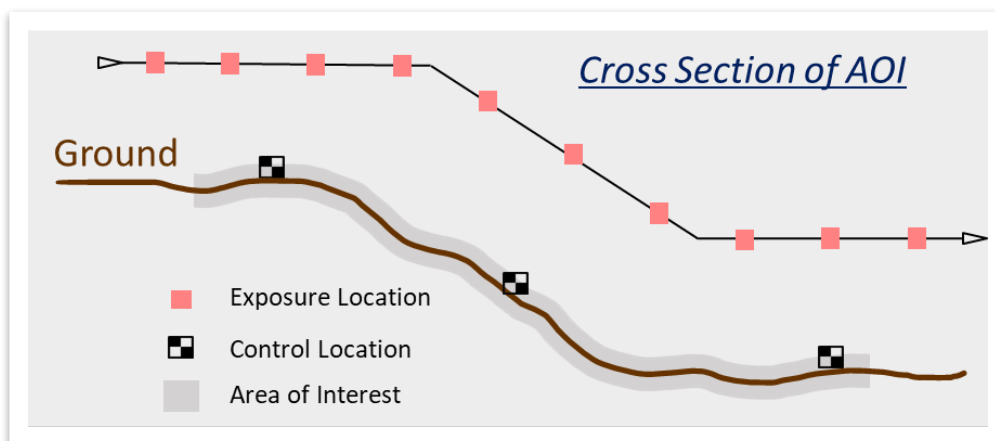

FIGURE 11. GROUND CONTROL POINT DISTRIBUTION - PROFILE



To validate the 3Dmodel or DTM, additional check points shall be surveyed and compared with the processed surface and denoted in the survey reported. For each GCP utilized in SfM software, there must be at least two additional check / validation points that were not utilized in the SfM orthorectification processing. For example, a site will have a minimum of five GCP's, and 10 check / validation points.

7.3.2 UAS LiDAR

UAS LiDAR requires a capable UAS platform for the sensor and accurate GNSS and IMU data. These inputs provide a relative positioning solution that is improved during post processing. While not necessarily within the mapping boundaries, base stations must be tied to the ground survey network associated with the mapping project. One or more static GNSS dual frequency receivers(s) at Base Stations (s) capable of producing RTK, or PPK data that can be downloaded and post processed. The PIC will determine the applicability of either RTK or PPK location correction depending on the UAS and project location. TDOT recommends that base stations not be more than 5 miles from the sensor at any time during the data acquisition. The UAS LiDAR operator is responsible for determining control requirements for the aerial survey to ensure it meets the accuracy and precision requirements for TDOT surveys.

Best practices to consider when acquiring UAS LiDAR:

- Wind conditions should be adequate to get optimal data collection and maintain safety standards.
- The collection rate of the UAS LiDAR systems sensors must be sufficient to meet project accuracy and point density requirements, it is suggested to acquire a density of 10 points per square foot or more.
- Refer to [Appendix C.18](#) for point cloud deviation map.
- Flight lines should be designed to contain at least 20% side lap from adjacent data.
- Aerial data shall not be collected when the ground is obscured by snow or ice.
- Refer and adhere to the laser eye safety standards described in [Section 7.1.4.1](#).

Ground control points and check points specifically for UAS LiDAR can be spaced further than that of a network designed for UAS Photogrammetry. Figure 8 in [Section 7.2.6.6](#) provides detail to a control and check point pattern that is also applicable to UAS LiDAR along a linear route. Control networks correlating to irregular or large areas should have at minimum 4 control points per LiDAR flight, with a minimum of 2 check / validation points per GCP. LiDAR check / validation points can be derived at photo ID locations or random spot shots across large areas.

7.3.3 Ground Control Point Design and Material

Ground control and accuracy verification must be completed regardless of if the UAS has RTK or PPK positioning. Control spacing, and configurations for the survey may be influenced by conditions. It is important that the UAS operators and the field survey team work in close coordination to ensure control requirements for the project are met. All UAS projects must be related to established project control, i.e., localized grid or TN State Plane Coordinate System, per TDOT project contract. Additional considerations include the type of sensor employed, the technology applied, and the required positional accuracy of the data.

The TDOT Regional Survey Coordinator or designee shall work closely with the UAS LiDAR & Photogrammetry operators when determining how many and where each Ground Control Point shall be located. The GCP target design shall be symmetrical and centered on the aerial control point. There are three designs commonly applied for aerial surveys. These include four-legged “X” targets, three-legged “Y” targets), and two-legged “L” targets (Figure 12). More than one type can be used for a project if there is a need to distinguish between different types of control, such as wing and center control point targets. The length and width of the target legs will depend on the specifications of the flight mission but typically 1 ft legs are sufficient. The principal drivers will be flying height or GSD of the resulting data.

FIGURE 12. AERIAL TARGET DESIGN EXAMPLES

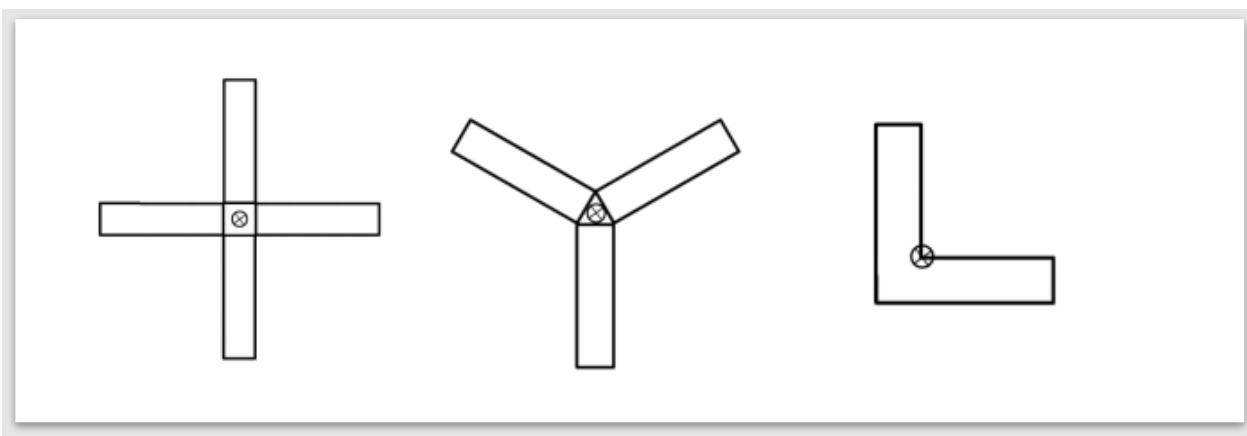

If paint is used as an aerial control point target, it must be of a type that is biodegradable and washes away within six months. Suggested materials for targeting include opaque polyethylene film (visquine of four to six mils thickness), unbleached white muslin or white cotton bunting. In flat terrain, plywood, or Masonite, painted flat white, may be used. When using either polyethylene film or material, it may be necessary to secure the target to the ground, either by stakes or nails. Placing rocks or dirt along the edges of the material may also help to keep it flat on the ground.

Natural target features, also known as Photo ID points or PID's may be used in lieu of artificial targets provided that a reasonably large angle of intersection exists to positively identify a point. Examples include sidewalk intersections, corner of concrete slabs, existing paint markings on asphalt, or other clearly visible feature from which a precise location can be interpreted.

The TDOT Region Survey Coordinator or designee shall work closely with the UAS operator when determining how monuments are to be targeted.

7.3.4 UAS Aerial Control Survey Report

Upon completion of the UAS aerial survey, whether performed by the consultant or TDOT survey crews, an Aerial UAS Survey Report shall be completed and filed with the TDOT Region Survey Coordinator. The project shall not be accepted as final without the UAS Aerial Control Survey Report.

The Aerial Survey Report shall include the following information:

- Project name & identification: County, route, Section, etc.
- Survey date, limits, and purpose
- Survey equipment checking and calibration report
- Date of targeting
- Surveyor's signature
- Personnel, equipment, and surveying methods used
- Problems encountered
- Description of all found or set photo control monuments (center and wing points)
- Description of targeting design and material (center and wing points)
- Coordinate Datum
 - a. Horizontal Datum
 - b. Vertical Datum
 - c. Project Elevation
 - d. State Plane Coordinate Zone
 - e. Project Combined Factor, including horizontal and vertical values used to compute factor
 - f. Meters to Feet Conversion (U.S. Survey Foot = 3937/1200)
 - g. Northing Reduction (truncated)
 - h. Easting Reduction (truncated)
 - i. For local low-distortion coordinate systems: A detailed statement of how to convert from the primary system, (such as State Plane), to project coordinates.
- Geodetic Coordinate Listing
 - a. Point's number or name
 - b. Latitude
 - c. Longitude
 - d. State Plane coordinate North
 - e. State Plane coordinate East
 - f. Ellipsoid height (if GNSS used)
 - g. Orthometric height (elevation)

- h. Geoid model (if applied)
 - i. Mapping angle
 - j. Scale
 - k. Point description (including, highway, milepost, and monument type, e.g., Type 2)
- Project Coordinate Listing
 - a. Ground Control Point (GCP) number
 - b. Northing and Easting
 - c. Elevation (orthometric)
 - d. Point description (including, highway, milepost, and control point/monument type, e.g., Type 2)
- Structure from Motion QA/QC reports including analysis of ground control and check / validation points accuracy.

Chapter 8: Subsurface Utility Engineering (SUE)

Subsurface Utility Engineering (SUE) services inherently require some surveying activities that fall under the purview of this manual. The SUE Consultant must certify horizontal and vertical accuracies of utility locations within ± 0.1 foot when performing Locate Services, (Test Hole) Quality Level A. To obtain these accuracies on a project, the surveyor shall tie the test holes to project control as defined in [Chapter 2](#) of this manual. These ties to project control shall conform to the minimum surveying standards and procedures as spelled out in this manual.

The SUE Consultant must certify horizontal accuracies of utility locations within ± 1 foot when performing Designating Services, Quality Level B. To obtain these accuracies on a project, the surveyor shall tie the utility designation points to project control as defined in [Chapter 2](#) of this manual. These ties to project control shall conform to the minimum surveying standards and procedures as spelled out in this manual.

Coordinate with the Project Manager in conjunction with the Region Surveyor and the Project Surveyor/Consultant to obtain horizontal and vertical data from appropriate project control, or to request supplemental control in the vicinity where the subsurface utility engineering activities are planned.

Refer to CI/ASCE 38- current edition, Standard Guideline for the Collection and Depiction of Existing Subsurface Utility Data, for procedures to perform D, C, B and A quality level services to obtain horizontal and vertical data, including designating and locating subsurface utilities. Refer to the website listed below.

<https://www.fhwa.dot.gov/programadmin/asce.cfm>

8.1 Utilities

All existing utilities within the project area shall be shown.

8.1.1 Owners

The owner of each utility shall be shown. Include name, address, contact person, email, and phone number. The Utility Coordination Office of each Region has the contacts for all the utilities.

8.1.2 Limits

When more than one utility company supplies the same service, the limits of each owner's service area shall be indicated.

8.1.3 Location and Profile

The location and depth of underground utilities shall be determined as best as possible. Profiles on gas lines and gravity-flow sewer lines are especially critical. However, gas lines shall never be sounded with a steel rod.

8.1.4 Underground

All underground utilities which may be affected by roadway or structure construction (as determined by the Regional Survey Manager) will be shown in the planimetrics file and plotted with present layout and profile. Other utilities within the proposed R.O.W. will be shown in the planimetrics file and plotted only on the present layout with approximate depth noted. In both cases, the utility representative's name, and the date the utility was located shall be recorded in the field book. Service lines will not be shown.

Surveys requiring the location of underground utilities should follow **CI/ASCE 38-02** "Standard Guideline for the Collection and Depiction of Existing Subsurface Utility Data."

A design locate request should be submitted through TN 811 stating that the work is being done by TDOT. The responses to the One Call ticket should be included with the Compliance Letter below. In accordance with T.C.A. § 65-31-118, underground utilities must respond within fifteen working days after a **design** locate request has been submitted to the one-call service for a proposed project by one of the methods designated in T.C.A. § 65-31-118(b)(1).

The **Survey One Call Compliance Letter** is a required deliverable for every project with utilities. It can be found under the **Standard Survey CADD Files and Documents >> Others** heading on this site:

<https://www.tn.gov/tdot/roadway-design/survey-standards/survey-cadd-files.html>

8.1.5 Overhead

Overhead utility lines between poles will not be shown on present layout plots. The direction of the lines will be indicated by a short line through the circle representing the pole. However, any wire, or low wire of a line group, crossing the centerline shall be shown with the station and elevation recorded and shown on the profile. A temperature reading shall be recorded and shown on the profile for all high-tension lines.

8.1.6 Signals

At signalized intersections, the signal heads, span wires, poles, and controller shall be recorded and shown on present layout plots.

8.1.7 Pole or Tower Number

The pole or tower number shall be recorded, if available, for major transmission lines.

8.1.8 Type of Utility

The type of service for each underground line and for each utility pole shall be noted using symbols shown on standard drawings RD-L-1, RD-L-2 RD-L-3, and RD-L-4. The standard drawings can be accessed through the following TDOT website:

RD-L-1

<https://www.tn.gov/content/tn/tdot/roadway-design/standard-drawings-library/standard-roadway-drawings/standard-roadway-title-sheet--abbreviations-and-legends/rd-a-11.html>

RD-L-2

<https://www.tn.gov/content/tn/tdot/roadway-design/standard-drawings-library/standard-roadway-drawings/standard-roadway-title-sheet--abbreviations-and-legends/rd-l-2.html>

RD-L-3

<https://www.tn.gov/content/tn/tdot/roadway-design/standard-drawings-library/standard-roadway-drawings/standard-roadway-title-sheet--abbreviations-and-legends/rd-l-3.html>

RD-L-4

<https://www.tn.gov/content/tn/tdot/roadway-design/standard-drawings-library/standard-roadway-drawings/standard-roadway-title-sheet--abbreviations-and-legends/rd-l-4.html>

8.1.9 Storm Sewers and Sanitary Sewers

Elevations shall be taken on the top and bottom of each manhole or catch basin and on the invert at each end of every pipe, including pipes that terminate in manholes. This information may be taken during the development of the DTM or as part of a separate level run. It is advisable to develop a table of elevations and numbering system for the pipes of a sewer system.

8.1.10 Septic and Drain Fields

In areas where there are no municipally owned sewer and water systems, information shall be shown on all developed property regarding sewage disposal and water supply. All septic tanks and field lines near the proposed roadway shall be located. However, a note indicating the location of facilities a considerable distance from the proposed roadway (or behind a building) will suffice.

8.1.11 Wells

Any drilled wells (gas, oil, or water) that will be inside the proposed roadway or that will be abandoned shall be shown. The name and address of the driller, the date drilled, the depth of the well and the name of the property owner at the time the well was drilled shall also be noted. If this information is available, it shall be listed in the planimetrics file adjacent to the well site.

8.1.12 Location for Pay Item Purpose

Responsibility for payment (Utility Co. or State) to relocate a utility is determined by its location within or without of present R.O.W. When utilities are close to the present R.O.W. or user's line, care shall be taken when developing the planimetrics file to indicate whether the utility is inside or outside of the present R.O.W. The Regional Utility Engineer shall be consulted when there is confusion about information to be shown.

8.1.13 Problems

Occasionally problems are encountered in the coordinating of the location of underground utilities. Any such problems shall be recorded in the project field book.

Chapter 9. Deliverables

All Subsurface Utility Engineering (SUE) mapping will be contained in the (insert file name here) file. All Survey data points, and information shall be included in this file and placed on the appropriate CAD levels.

In most cases, engineer CAD files are aligned to plot with the reference alignments to appear horizontally across the plan sheets. Stationing will almost always run from left to right across the plan sheets. Generally, all SUE text and labels should be arranged to appear parallel with the nearest reference alignment and to read left to right going up in stationing. When possible, it is important to verify the engineer's layout and to request specific guidance on the orientation appearance of the SUE planimetry information.

All utility structure information shall be mapped per the ORD Subsurface Utility Engineering (SUE) checklist in [Section 9.2](#).

All Survey Control used for SUE projects shall be established per Chapter 2 of this survey manual.

9.1 DGN Files

The survey report shall be accompanied by all field notes used in the survey or printouts or electronically recorded field notes. The survey shall be collected to Level 1 relative accuracies.

The following files shall be included:

- Original Field Data
- File describing the basis of survey elements and datum in accordance with department standards
- The files must be named according to the **TDOT ORD File Naming** convention. This document can be found under the **Requirements and Guidelines** heading on this site:
<https://www.tn.gov/tdot/roadway-design/tdot-cadd-support/ord-resources.html>
- Design criteria for each type of road can be found in the TDOT Standard Roadway and Structure Drawings under the **Roadway Design Standards** heading on this site:
<https://www.tn.gov/tdot/roadway-design/standard-drawings-library.html>

9.2 Checklists / Forms

The following files shall be included:

- Deliverables referencing the ORD survey QAQC checklists and supplemental templates. Refer to the TDOT website below for the most current documented procedures:

<https://www.tn.gov/content/tn/tdot/roadway-design/tdot-cadd-support/ord-training-material/survey-checklist-documents.html>

9.3 Supplemental Files

The following files shall be included:

- File containing original field survey notes or raw field data when obtained with Data Collectors. The raw data in the native data collector format. (e.g., DC, RINEX, RW5, ASCII, or DAT) file format and log sheets must also be preserved for future retrieval.

Revision History

DATE (MONTH/YEAR)	AUTHOR/EDITOR	IB #	SECTIONS MODIFIED
August/2023	Brad Montgomery		4.14.3, Appendix A.1 and A.6
October/2023	Brad Montgomery		Appendix A.1 and A.8

Appendix A. TDOT Survey Feature Codes

TRANSPORTATION FEATURES		
Feature Code	Description	IN DTM
BE	Business Entrance	Y-2
BIKE	Bike Path	Y-2
CU	Curb (At Bottom W/BL At Top)	Y-2
DR	Driveway	Y-2
EP	Edge of Pavement	Y-2
FE	Field Entrance	Y-2
GRCB	Cable Barrier	NO
GRM	Guardrail Median	NO
GRL	Guardrail Left	NO
GRR	Guardrail Right	NO
IMP	Impact Attenuator	Y-1
JB	Jersey Barrier	Y-2
PK	Parking Lot	Y-2
RD	Edge of Road	Y-2
RR	Railroad	Y-2
RWAY	Airport Runway	Y-2
RWT	Ret. Wall (At Top and Bottom)	Y-2
RWTWF	Ret. Wall W/Fence (At Top)	Y-2
SWT	Sidewalk	Y-2
SH	Edge Of Shoulder	Y-2
TRAIL	Trail	Y-2
TUN	Tunnel	NO
XHRAMP	Handicap Curb Opening	NO
XRRSW	Railroad Switch	Y-1

NON-TRANSPORTATION FEATURES		
Feature Code	Description	IN DTM
AFLD	Athletic Field	Y-2
BC	Building	Y-4
CNPY	Fuel/Service Station Canopy	NO
CG	Cattle Guard	Y-1
CEM	Cemetery	Y-1
FN	Fence	Y-1
GATE	Gate	Y-1
GRAVE	Grave	Y-1

NON-TRANSPORTATION FEATURES		
Feature Code	Description	IN DTM
PAD	Miscellaneous Pad	Y-2
PIT	Quarry or Pit	Y-2
ROCKWL	Rock Wall Left	Y-2
ROCKWR	Rock Wall Right	Y-2
RWP	Ret. Wall (Private) (AT BOTTOM W/BL AT TOP)	Y-2
RWPWF	Ret. Wall W/Fence (AT BOTTOM W/BL AT TOP)	Y-2
SEP	Septic Field Line	Y-1
SIGNP	Sign (Private)	NO
SWP	Sidewalk (Private)	Y-2
TANK	Tank (UG or Above Ground)	NO
TOWER	Tower	Y-1
XFE	Floor Elevation	NO
XFLAG	Flag Pole	Y-1
XFP	Fence Post	Y-1
XMB	Mail Box	Y-1
XSATLIT	Satellite Dish	Y-1
XSEP	Septic Tank	Y-1
XSIGNP	Small Private 1-Post Sign	Y-1
XWELL	Well	NO

DRAINAGE		
Feature Code	Description	IN DTM
ABUT	Bridge Abutment	Y-2
APRON	Paved Apron	Y-2
BEAM	Bridge Bottom Beam	NO
BRI	Bridge	NO
CRK	Creek	Y-2
CRKB	Creek Bed	Y-2
CV	Culvert	Y-1
DAM	Dam	Y-2
DECK	Bridge Deck breaklines	NO
DIT	Paved Ditch	Y-2
DOWN	Downstream Flood Section	NO
EW	End Wall (At Bottom W/BL At Top)	Y-2
GAGE	Stream Gage	Y-1
LAKE	Lake	Y-2
LEVEE	Levee	Y-2

Appendix A. TDOT Survey Feature Codes

DRAINAGE		
Feature Code	Description	IN DTM
PIER	Bridge Pier	Y-2
PIPE	Pipe	Y-1
POND	Pond	Y-2
RIVER	River	Y-2
RPDS	Rapids/Waterfall	Y-2
RRAP	Rip-Rap	Y-2
SINK	Sinkhole	Y-2
SPILL	Spillway	Y-2
?STS	Storm Sewer	NO
SKE	Bridge Sketch	NO
TB	Top Of Bank	Y-2
UP	Upstream Flood Section	NO
WET	Wetland Boundary	Y-2
XBOTST	Bottom Of Storm MH, CB, Etc	NO
XCB	Catch Basin	Y-1
XDECK	Bridge Deck	NO
XDI	Drop Inlet	Y-1
XHW	High Water Elevation Point	Y-2
XNW	Normal Water Elevation Point	Y-2
XOHW	Ordinary High Water Mark	NO
XSPRING	Spring	Y-1
XMHSTS	Storm Sewer Manhole	Y-1

R.O.W./PROPERTY		
Feature Code	Description	IN DTM
ESMT	Easement	NO
ESMTD	Drainage Easement	NO
PARCEL	Parcels	NO
PL	Property Line	NO
PLWF	PL W/Fence	NO
ROW	ROW Line	NO
ROWWF	ROW W/Fence	NO
XIP	Iron Pin Existing	NO
XMON	Concrete Marker	NO
XPL	Property Corner	NO
XROW	R.O.W. Monument	NO
XROWA	R.O.W. Monument (inline)	NO

Appendix A. TDOT Survey Feature Codes

R.O.W./PROPERTY		
Feature Code	Description	IN DTM
XROWB	R.O.W. Monument (corner)	NO

POLITICAL BOUNDARIES		
Feature Code	Description	IN DTM
CITY	City Limits	NO
COUNTY	County Line	NO
STATE	State Line	NO

UTILITIES		
Feature Code	Description	IN DTM
?GL	Gas Line	NO
OHW	Overhead Wire	NO
PTOW	Trans. Tower	Y-1
?SAS	Sanitary Sewer	NO
?FMS	Force Main Sanitary Sewer	NO
XBOTSA	Bottom Of Sanitary Manhole	NO
XCA	SUE Level-A Cable Point	NO
XEA	SUE Level-A Electric Point	NO
XFOA	SUE Level-A Fiber Optic Point	NO
XFMA	SUE Level-A Force Main Point	NO
XGA	SUE Level-A Gas Point	NO
XTA	SUE Level-A Telephone Point	NO
XWA	SUE Level-A Water Point	NO
UGF	Fiber Optic (UG)	NO
UGP	Power (UG)	NO
UGT	Telephone (UG)	NO
UGC	Cable (UG)	NO
?WL	Water Line	NO
XFH	Fire Hydrant	NO
XGAA	Guy Device Angle Anchor	Y-1
XGM	Gas Meter	NO
XGV	Gas Valve	NO
XGVA	Guy Device Vertical Anchor	Y-1
XGW	Guy Wire	Y-1
XLP1	Light Pole 1 Light	Y-1

Appendix A. TDOT Survey Feature Codes

UTILITIES		
Feature Code	Description	IN DTM
XLP2	Light Pole 2 Lights	Y-1
XLP3	Light Pole 3 Lights	Y-1
XLP4	Light Pole 4 Lights	Y-1
XLW	Low Wire Crossing	NO
XMH	Manhole	Y-1
XMHC	Cable Manhole	Y-1
XMHF	Fiber Optic Manhole	Y-1
XMHG	Manhole Gas	Y-1
XMHP	Manhole Power	Y-1
XMHSAS	Sewer Manhole	Y-1
XSM	Sewer Meter	NO
XSV	Sewer Valve	NO
XUM	Misc. Utility Feature	NO
UM	Misc. Utility Line	NO
XMHT	Telephone Manhole	Y-1
XMHW	Manhole Water	NO
XPB	Utility Boxes (Pull Box)	NO
XUP	Utility Pole	Y-1
XUPL	Utility Pole with Light	Y-1
XHMLPH	High Mast Light (Half)	Y-1
XHMLPF	High Mast Light (Full)	Y-1
XLCC	Lighting Control Center	NO
XEV	Electric Vehicle Charging Station	Y-1
XTBOX	Telephone Box	Y-1
XTOWER	Radio/TV Tower	Y-1
XTPED	Tele. Pedestal	Y-1
XFPED	Fiber-Optic Pedestal	Y-1
XCPED	Cable Pedestal	Y-1
XWM	Water Meter	NO
XWV	Water Valve	NO

VEGETATION		
Feature Code	Description	IN DTM
TREE	Tree Drip Line	Y-1
HEDGE	Hedge Line	Y-1
XBUSH	Bush	Y-1
XTREES	Small Tree under 6" Diameter	Y-1
XTREEM	Med. Tree 6" – 12" Diameter	Y-1
XTREEL	Large Tree over 12" Diameter	Y-1

NOTE: (Descriptor Format: =??" TREE TYPE)

TRAFFIC CONTROL		
Feature Code	Description	IN DTM
BARR	Barricade	NO
LDECT	Loop Detector	NO
LLD	Lane Line Dashed	Y-1
LLDS	Lane Line Dashed Short	Y-1
LLS	Lane Line Solid	Y-1
SIGNT	Transportation Sign	NO
XOHS	Overhead Sign EX: SCHOOL X	NO
XPDMC	Pad Mounted Controller	NO
XPDSHN	Pedestrian Signal	NO
XPLMC	Pole Mounted Controller	NO
XPPH	Pedestrian Pushbutton	NO
XPULLB	Pull Box	NO
XRRFS	RR Flashing Signal Crossing	NO
XRRFSG	RR Flashing Signal Crossing W/Gate	NO
XRRSIG	Railroad Signal	NO
XSHN	Traffic Signal Head	NO
XSHNB	Signal Head W/Backplate	NO
XSIGN1	Small 1-Post Sign	Y-1
XSIGN2	Small 2-Post Sign	Y-1
X2SIGN	Small 2-Faced Sign	Y-1
XSPSS	Strainpole	Y-1
XWPSS	Wood Signal Pole	Y-1

TRAFFIC CONTROL (PAVT. MARKING)		
Feature Code	Description	IN DTM
CWALK	Crosswalk	NO
STOP	Stop Bar	NO
YIELD	Yield Bar (Triangles)	NO
XLAR	Left Arrow Pavement Marking	NO
XLRAR	Lt & Rt Arrow	NO
XONLY	Only Pavement Marking	NO
XPVTXT	Pave. Marking Words (CENTER)	NO
XRAR	Right Arrow Pavement Marking	NO
XRRPAV	Railroad Xing Pavement Marking	NO
XSAR	Straight Arrow	NO
XRARI	Right Arrow Interstate	NO
XSARI	Straight Arrow Interstate	NO
XSRARI	Straight & Right Arrow Interstate	NO
XHOV	HOV Diamond	NO
XSLAR	Straight & Lt Arrow	NO
XSLRAR	Straight, Lt & Rt Arrow	NO
XSRAR	Straight & Rt Arrow	NO
XRLAR	Roundabout Left Arrow	NO
XRSLAR	Roundabout Straight/Left Arrow	NO
XRSLRAR	Roundabout Straight/Left/Right Arrow	NO
XSUBIKE	Bike Pavement Marking Suburban	NO
XUBIKE	Bike Pavement Marking Urban	NO
XYIELD	Pavement Yield Marking (Spelled Out)	NO
XHC	Parking Handicap Symbol (Locate Center)	NO

NOTE: Locate all pavement arrows at center of traffic lane relative to bottom of arrow.

TERRAIN MODEL		
Feature Code	Description	IN DTM
BL	Breakline	Y-2
OL	Obscure Line	Y-4
XP	Ground Point	Y-1

SURVEY CONTROL		
Feature Code	Description	IN DTM
XBM	Benchmark	NO
XCP	Control Point	Y-1
XCK	Check Point	NO
XTRAV	Traverse Point	Y-1
XSPUR	Temporary Survey Point	NO
XH	Horz. Photo Point	Y-1
XV	Vert. Photo Point	Y-1
XHV	Horz/Vert Photo Point	Y-1

MISCELLANEOUS & DEFAULT CODES		
Feature Code	Description	IN DTM
DEFAULT_CHAIN	Default Item	NO
DEFAULT_CURVE	Default Item	NO
DEFAULT_LINE	Default Item	NO
DEFAULT_PARCEL	Default Item	NO
DEFAULT_POINT	Default Item	NO
DEFAULT_SPIRAL	Default Item	NO
DASH	Dash Line	NO
DOT	Dotted Line	NO
LD	Long Dash Line	NO
MISC	Miscellaneous	NO
SOLID	Solid Line	NO
XMISC	Misc. Unknown Point	NO

OFFICE CODES		
Feature Code	Description	IN DTM
CL	Proposed Centerline	NO
DBDRY	Drainage Map Boundary	NO
EXCL	Existing Centerline	NO
X_PROPERTY	Property Development	NO
XPOINT	HiVis Generic Office Pt	NO

DTM CODES	
NO	Do Not Include in DTM
Y-1	Include as a Spot in DTM
Y-2	Include as a Spot and a Break Line in DTM
Y-3	Include as a Void in DTM
Y-4	Include as a Drape Void in DTM
Y-5	Include as a Break Void in DTM
Y-6	Include as an Island in DTM
Y-7	Include as a Boundary in DTM
Y-8	Include as a Contour in DTM

The term “feature” refers to any “material object” or “item” or “thing” that exists in the field. Features can be overhead, at ground level, underground, or under water.

The term “locate” refers to using a Total Station, GPS RTK equipment, or scanning equipment to obtain the position of a feature.

All features in a project should be located in the field. However, features located on an aerial survey don’t need to be located in the field, except for roads. This data is imported into a Field Book in Open Roads Designer (ORD). Data that is imported into a Field Book is automatically drawn in ORD. The ORD files are used by roadway designers, bridge designers, hydraulics designers, ROW personnel, utilities personnel, and others.

Survey “Points” are used to create the survey drawings.

- Points’ names are alphanumeric, and begin with an “S” (for Survey), followed by either a number (Example: S101), or by other letters and a number (Example: SMP101)
- Point numbers are in ascending order, like the ASCII Points list below.

```
S2,734560.977,1979252.352,513.780,XCP
S6,735958.749,1980677.032,510.710,XCP
S10,733973.954,1978899.516,515.380,+RD
S11,733974.522,1978898.644,515.301,+SH
S12,734007.251,1978919.232,515.174,RD
S13,734008.100,1978918.267,515.088,SH
S14,734045.109,1978940.752,514.876,SH
S15,734044.446,1978941.658,514.954,RD
S16,734078.331,1978962.385,514.650,RD
S17,734078.993,1978961.247,514.617,SH
S18,734111.900,1978981.211,514.408,SH
S19,734110.918,1978982.304,514.495,RD
S20,734145.717,1979003.434,514.256,RD
S21,734146.328,1979002.164,514.194,SH
```

Appendix A. TDOT Survey Feature Codes

- Every point should be given a TDOT Feature Code, along with a descriptor as required.
- A Feature Code for a point will result in drawing one of two things
 - A Symbol
 - A Line
- Symbol: When any Feature Code starts with the letter “X”, a symbol will be drawn. Example: XUP draws a utility pole .
- Line: When any Feature Code does not start with the letter “X”, a line will be drawn.
 - The starting point on a line has to have a “Linking Code”. We use “+” (Example: +FN)
 - The ending point on a line has to have a different “Linking Code”. We use “-” (Example: -FN)
 - Any middle points on a line have just the code. (Example: FN)
 - To close a figure, we use “*” (Example: *FN)
 - Other Line Linking Codes, for Begin Curve, Point on Curve, End Of Curve, etc. are not covered in this document.
 - After a line is ended, that same code can be used again. Even the next point is okay.

```
S5003,733960.5840,1978923.4490,514.5905,+SH
S5004,733968.5402,1978927.1700,514.6391,-SH
S5005,733980.2806,1978933.5584,514.6291,+SH
S5006,733984.2121,1978933.2145,514.6667,SH
S5007,733986.2878,1978934.0319,514.7172,SH
S5008,733995.9284,1978939.3569,514.6552,-SH
```

- More than one line can be “open” at a time, as in the example below.

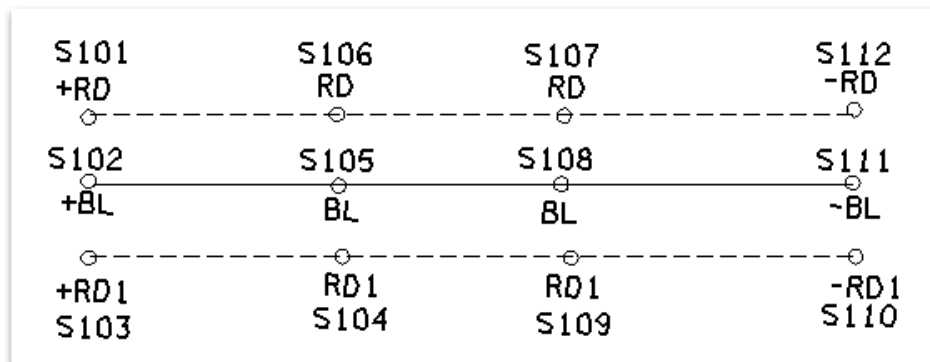

- A point may need a descriptor, which will be “drawn” as text in Microstation. To add a descriptor, a delimiter character is placed after the Feature Code, and the descriptor is typed after that. Use “=”. For lines, the descriptor should be recorded on only one point on the line. If it is recorded for every point on the line, many text elements would be drawn and would have to be erased. Adding the descriptor to the first point on a line is expected.

Examples: XUP=P/T/C +RD=MAIN ST. (ASP.)

- For most Feature Codes, if a solid or a dashed line is to be drawn by the code, there should be text on the drawing to describe what it is, so it should have a descriptor.
- On any vertical features, code the bottom as the feature, and locate a breakline along the top. Vertical features include curbs, retaining walls, end walls, and bridge abutments.
- For Box Culverts and Oval Pipes, always list the span length first.
- If a Feature has a formal name, use it in the descriptor. This includes lakes, creeks, rivers, ponds, tunnels, athletic fields, buildings, cemeteries, and bridges.
- Most symbols will require a descriptor.
- Locate all pavement arrows at the center-bottom of the arrow.



The Feature Codes







The following is a listing of:

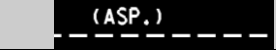
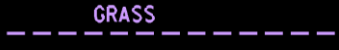

- Each Feature Code
- What the code represents
- An example of what to type in the data collector
- What it will draw in Microstation
- Samples of possible descriptors, in square-brackets
- Photos showing the feature and where to locate it
- Any other general information about the code.

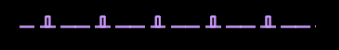

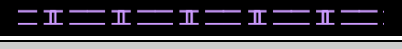
In the Microstation drawing examples for lines, just one straight line and any text for it is shown.

A.1 Transportation Features

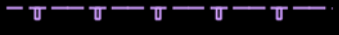

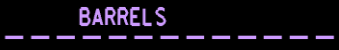
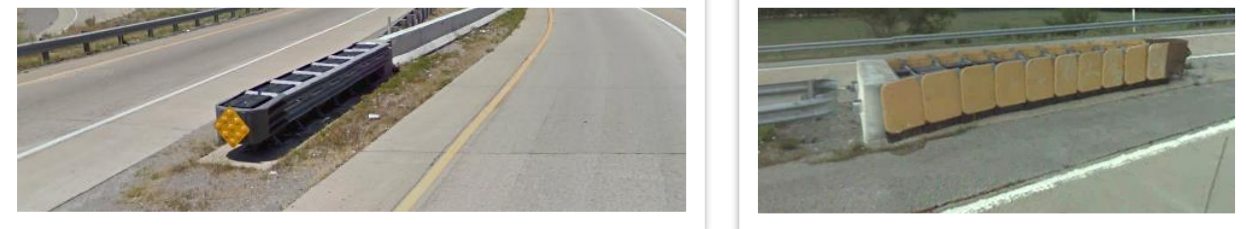
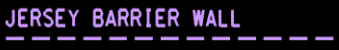
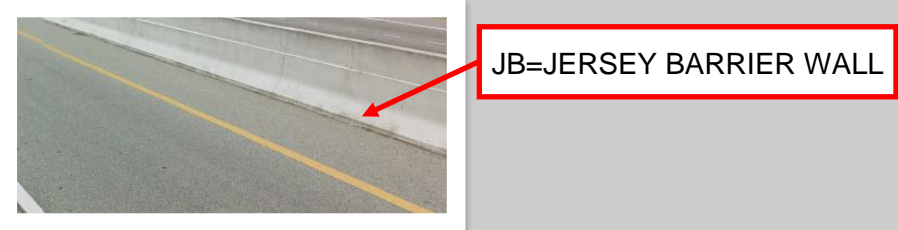
TRANSPORTATION FEATURES			
Feature Code	Description	Descriptor (if applicable)	Graphic(s)
BE**	Business Entrance	BE=ASP.	ASP. -----
<i>[ASPH., CONC.] This is a driveway for a business.</i>			
BIKE**	Bike Path	BIKE=BIKE PATH (ASP.)	BIKE PATH (ASP.) -----
<i>[BIKE PATH (ASPH.)] This is a multi-use path, paved or unpaved, that is separate from or adjacent to the traveled way. If unpaved, locate the center of the path.</i>			
CU**	Curb	CU=CURB	CURB -----
<i>[C & G, CURB, MOUNTABLE CURB] Locate the bottom edge of the curb. See A.14.1 Road Photo 1 for more details.</i>			

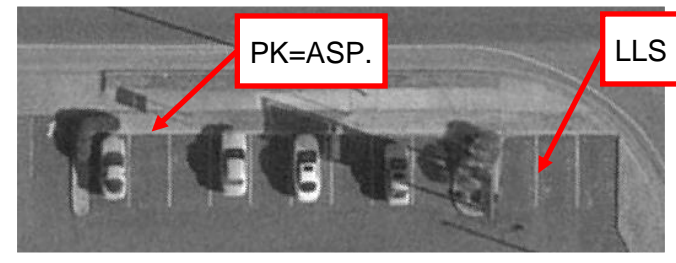
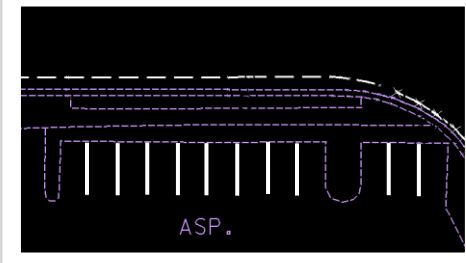
TRANSPORTATION FEATURES			
Feature Code	Description	Descriptor (if applicable)	Graphic(s)
DR**	Driveway	DR=GR.	
<i>[GR., ASPH., CONC., DIRT, PEA GR.] Locate driveways from the road to the DTM limits at a minimum. Don't just locate a driveway for a few feet, then stop.</i>			
EP**	Edge of Pavement	EP=(ASPH.)	
<i>This code is only used in special circumstances where the changes in pavement material needs to be located.</i>			
FE**	Field Entrance	FE=GRASS	
<i>[DIRT, GRASS, GR.] FE is a driveway into a field or other undeveloped land.</i>			
GRCB	Cable Barrier		
<i>Locate the center of the cable rail, at ground elevation.</i>			
GRL	Guardrail Left		
<i>Locate the face of the rail, at ground elevation. GRL draws the posts on the left side of the rail. Continue guardrail across bridges if it does so in the field.</i>			
			
GRM	Guardrail Median		
<i>Locate the centerline of the guardrail.</i>			
			

TRANSPORTATION FEATURES			
Feature Code	Description	Descriptor (if applicable)	Graphic(s)
GRR	Guardrail Right		
<p>Locate the face of the rail, at ground elevation. GRR draws the posts on the right side of the rail. Continue guardrail across bridges if it does so in the field.</p>			
			
IMP**	Impact Attenuator	IMP=BARRELS	
<p>[IMPACT BARRELS, IMPACT ATTENUATOR] Locate around outside of impact attenuator at ground level.</p>			
			
JB**	Jersey Barrier	JB=JERSEY BARRIER WALL	
<p>[JERSEY BARRIER WALL] Locate both sides of the wall, where the wall meets the road.</p>			
			



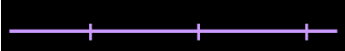
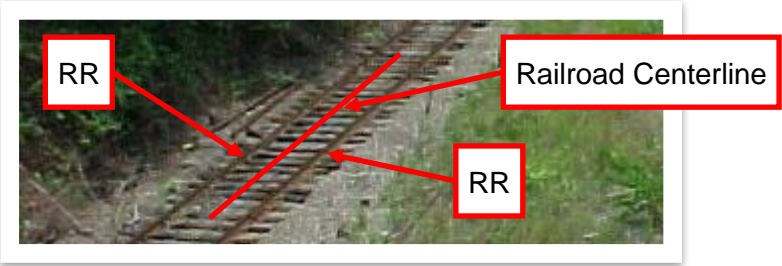
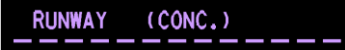

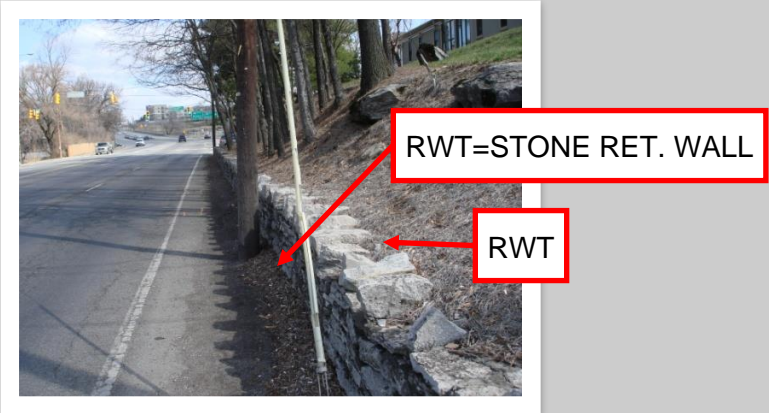
TRANSPORTATION FEATURES			
Feature Code	Description	Descriptor (if applicable)	Graphic(s)
PK**	Parking Lot	PK=ASP.	ASP.
<p><i>[ASP., CONC., GR.] PK is used for the edges of a parking lot. If there is a curb around the parking area, use the CU Feature Code. A descriptor is required for the general parking lot boundary, but not for each parking space line. For all parking stripes, use the LLS Feature Code.</i></p>			
<div style="display: flex; justify-content: space-around;">   </div>			
RD**	Edge Of Road	RD=MAIN ST. (ASP.)	MAIN ST. (ASP.)
<p><i>On a Road, the actual lanes that vehicles drive in are known as the “Traveled Way”. Outside the Traveled Way can be shoulders. Shoulders may not have as thick and strong a base material as the Traveled Way; therefore, the Traveled Way and the shoulder are two different features.</i></p> <p><u><i>The edges of the Traveled Way should always be located.</i></u></p> <p><i>If the road has no distinguishing features, the outside edge of pavement marking should be used. If a road doesn’t have these lines, use a best-judgement determination of the location of the Traveled Way. If edge of traveled way and edge of pavement marking are less than 2 feet apart only locate edge of traveled way as RD. See A.14.1 Road Photo 1, A.14.2 Road Photo 2, A.14.3 Road Photo 3, A.14.4 Road Photo 4, and A.14.5 Road Photo 5 for more details.</i></p>			
			

Appendix A. TDOT Survey Feature Codes

TRANSPORTATION FEATURES			
Feature Code	Description	Descriptor (if applicable)	Graphic(s)
RR	Railroad		
<i>Locate the top center of each individual rail on a railroad. A railroad centerline is computed in the office for each set of rails.</i>			
			
RWAY**	Airport Runway	RWAY=RUNWAY (CONC.)	
<i>[RUNWAY]</i>			
RWT**	Ret. Wall (Transportation)	RWT=STONE RET. WALL	
<i>[STONE RET. WALL, BLOCK RET. WALL] RWT is for retaining walls that are part of the transportation system. Locate the face of the wall, at the bottom of the wall. Also locate the back of the wall on top.</i>			
			

Appendix A. TDOT Survey Feature Codes

TRANSPORTATION FEATURES			
Feature Code	Description	Descriptor (if applicable)	Graphic(s)
RWTWF**	Ret. Wall w/ Fence (Trans.)	RWTWF=BLOCK RET. WALL W/FENCE	
<i>Same as RWT, but with a fence on top of the wall. Use this code at the top of the retaining wall next to the fence not at the face of the retaining wall.</i>			
SH**	Edge of Shoulder	SH=ASP.	
<i>[ASPH., CONC., GR.] Locate shoulders. Do not locate pavement outside the edge of the Traveled Way as a shoulder unless it is approximately 2' wide or wider. See Feature Code RD and A.14.3 Road Photo 3 for more details.</i>			
SWT**	Sidewalk (Transportation)	SWT=S.W.	
<i>[S.W., S.W. (BRICK), S.W. (STONE)] SWT is for sidewalks that were built as part of the transportation system. Describe the sidewalk's material if it is not concrete.</i>			
TRAIL**	Trail	TRAIL=GR.	
<i>[GR., ASPH., CONC.]</i>			
TUN**	Tunnel	TUN=TUNNEL	
<i>[TUNNEL] Locate the outer edges of the tunnel. If the tunnel has a name, add that to the descriptor. No BL's or RD's or SH's go into the tunnel. The descriptor contains the dimensions (width first), the material(s) the tunnel is made of, the tunnel's shape, and the word "TUNNEL".</i>			

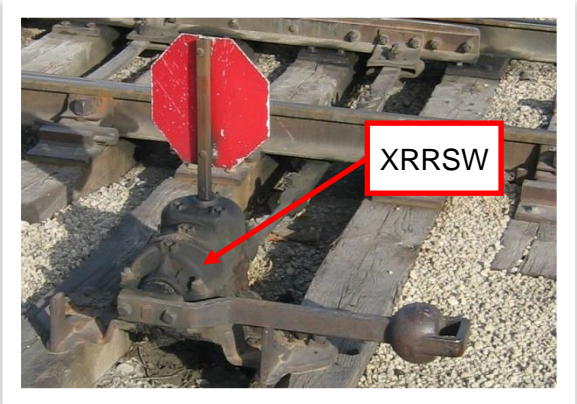

TRANSPORTATION FEATURES			
Feature Code	Description	Descriptor (if applicable)	Graphic(s)
XHRAMP	Handicap Curb Opening		
<div style="display: flex; justify-content: space-around;">   </div>			
XRRSW	Railroad Switch		
			



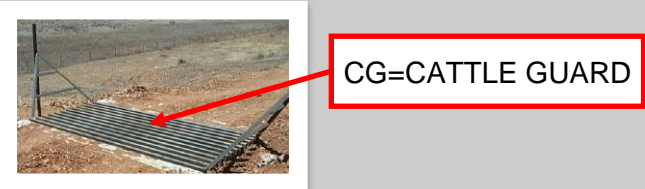

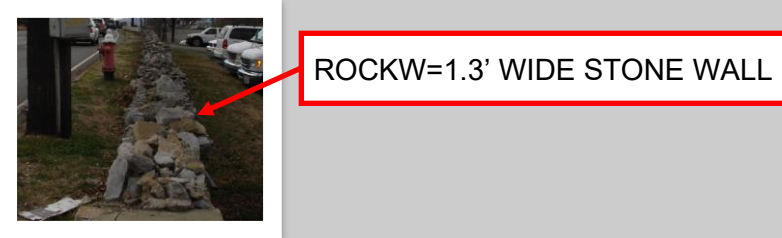
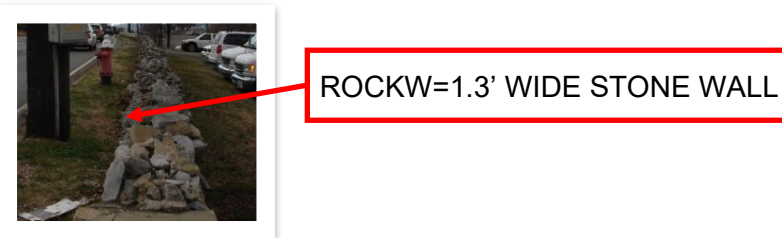

****A descriptor is required.**





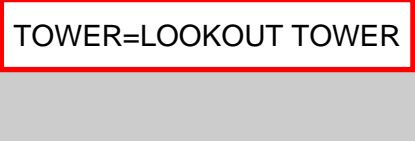

A.2 Non-Transportation Features

NON-TRANSPORTATION FEATURES			
Feature Code	Description	Descriptor (if applicable)	Graphic(s)
AFLD**	Athletic Field	AFLD=BASEBALL FIELD	BASEBALL FIELD
<i>[FOOTBALL FIELD, BASEBALL FIELD, SOCCER FIELD, GOLF COURSE] Outline fields only if not bounded by a fence.</i>			
BC**	Building	BC=1-S-B	1-S-B RES.
<i>[1-S-B RES., 2-S-BL, 1-S-F ABC ELECTRIC COMPANY, MCDONALD'S RESTAURANT, STRIP SHOPPING (VACANT), SHED, BARN, TRAILER, WELL HOUSE] The full outline of the building should be drawn. Buildings within the DTM limits of the project shall be located. Digitize the shape of the back of large buildings that extend far beyond DTM width.</i>			
CG**	Cattle Guard	CG=CATTLE GUARD	CATTLE GUARD
<i>[CATTLE GUARD] Locate the outline of the cattle guard.</i>			
			
CEM**	Cemetery	CEM=DOE CEMETERY	DOE CEMETERY
<i>[CEMETERY] Locate the boundary of the cemetery.</i>			
CNPY**	Canopy	CNPY=GAS STATION CANOPY	GAS STATION CANOPY
<i>[GAS STATION CANOPY, OVERHANG] Locate the outline of the canopy.</i>			
FN**	Fence	FN=BARBED WIRE	BARBED WIRE
<i>[BARBED WIRE, WOVEN WIRE, ELECTRIC, BOARD, PVC] Locate all fences or portions thereof within the dtm limits. Fences are important, no matter the age or type, can help determine property and ROW lines.</i>			
GATE	Gate		GATE

NON-TRANSPORTATION FEATURES			
Feature Code	Description	Descriptor (if applicable)	Graphic(s)
GRAVE**	Grave	GRAVE=GRAVE	GRAVE
<i>[GRAVE] Locate either the outline of the grave, or just a single line along the length of the grave. If a cemetery boundary line has been located, just locate the graves closest to the centerline.</i>			
PAD**	Miscellaneous Pad	PAD=CONC. PAD	CONC. PAD _____
<i>[CONC. PAD] Locate the outline of the entire pad.</i>			
PIT**	Quarry or Pit	PIT=ROCK QUARRY	ROCK QUARRY -----
<i>[PIT, ROCK QUARRY]</i>			
ROCKWL**	Rock Wall	ROCKWL=1.3' WIDE STONE WALL	1.3' WIDE STONE WALL ○○○○○○○○○○○○○○○○○○○○
<i>Locate the left face of the wall, at ground elevation. The feature will show to the left of the survey chain. The descriptor requires the width and material.</i>			
			
ROCKWR**	Rock Wall	ROCKWR=1.3' WIDE STONE WALL	1.3' WIDE STONE WALL ○○○○○○○○○○○○○○○○○○○○
<i>Locate the right face of the wall, at ground elevation. The feature will show to the right of the survey chain. The descriptor requires the width and material.</i>			
			



NON-TRANSPORTATION FEATURES			
Feature Code	Description	Descriptor (if applicable)	Graphic(s)
RWP**	Ret. Wall (Private)	RWP=STONE RET. WALL	STONE RET. WALL -----
<i>[STONE RET. WALL] RWP is a retaining wall that is privately owned. See Feature Code RWT for further details.</i>			
RWPWF**	Ret. Wall w/Fence	RWPWF=BLOCK RET. WALL W/FENCE	BLOCK RET. WALL W/FENCE -----x-----x-----
<i>Same as RWP, but with a fence on top of the wall.</i>			
SEP**	Septic Field Line	SEP=FIELD LINES	FIELD LINES -----
<i>[FIELD LINES] All septic tanks and field lines near the proposed roadway shall be located.</i>			
SIGNP**	Sign (Private)	SIGNP=SIGN	SIGN -----
<i>[SIGN, BILLBOARD] SIGNP is for signs that are privately owned. Locate the extent of the sign including overhanging portions. Only describe what is written on the sign if it is historical.</i>			
<div style="display: flex; justify-content: space-around; align-items: center;"> <div style="text-align: center;">  <p>+SIGNP=SIGN</p> <p>-SIGNP</p> </div> <div style="text-align: center;">  <p>+SIGNP=SIGN</p> <p>-SIGNP</p> </div> </div>			
SWP**	Sidewalk (Private)	SWP=S.W.	S.W. -----
<i>[S.W., S.W. (BRICK), S.W. (STONE)] SWP is for sidewalks that are privately owned. Describe the sidewalk's material if it is not concrete.</i>			



NON-TRANSPORTATION FEATURES			
Feature Code	Description	Descriptor (if applicable)	Graphic(s)
TANK**	Tank (UG or Above Ground)	TANK=PROPANE TANK	
<i>[PROPANE TANK] Locate the outline of the tank.</i>			
			
TOWER**	Tower	TOWER=RADIO TOWER	
<i>[RADIO TOWER, LOOKOUT TOWER] Locate around all tower legs.</i>			
			
<div style="border: 2px solid red; padding: 5px; display: inline-block;">TOWER=LOOKOUT TOWER</div> 			
XFE	Floor Elevation		
<i>Use XFE only in areas prone to flooding.</i>			
XFLAG	Flag Pole		

NON-TRANSPORTATION FEATURES			
Feature Code	Description	Descriptor (if applicable)	Graphic(s)
XFP	Fence Post		
<i>Locate the center of the fence post. Only locate individual posts not captured along a fence line.</i>			
XMB	Mail Box		
Mailboxes don't need to be located unless they are large, expensive ones. Locate the Center of the mailbox.			
XSATLIT	Satellite Dish		
<i>Locate the center of the satellite dish support. Do not locate satellite dishes attached to buildings.</i>			
XSEP	Septic Tank		
XSIGNP	Small Private 1-Post Sign		
<i>Locate the center of the sign. If the face of the sign is wide, use the Feature Code SIGNP. In the office, rotate the sign to face correctly.</i>			
			
XWELL	Well		
<i>For any wells (Oil, Gas or Water) that will be within the limits of the proposed ROW, capture the location of the center of the well and note the name and address of the driller, the date drilled, the depth of the well and name of the property owner at the time the well was drilled.</i>			

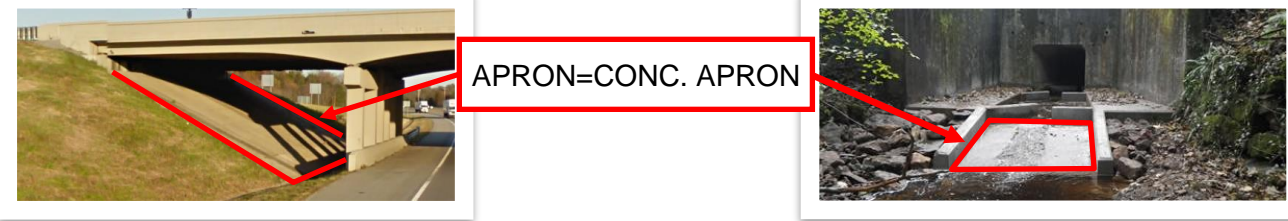



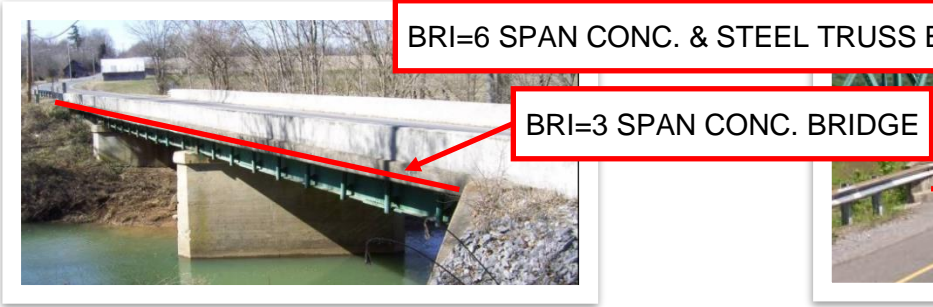
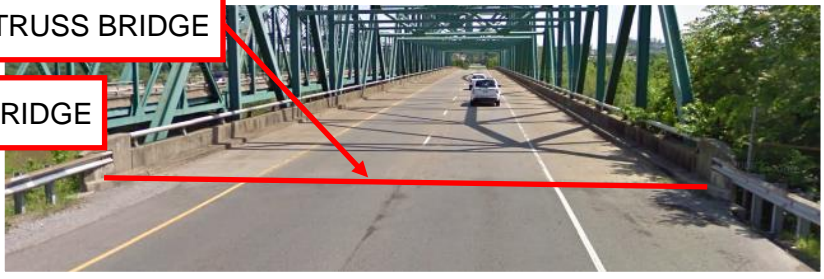
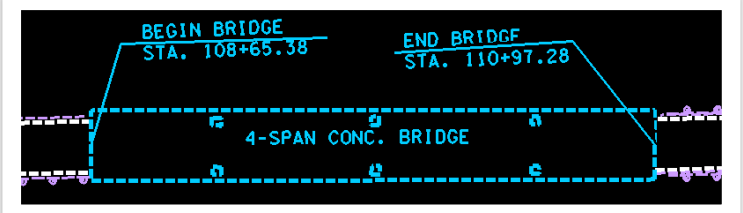



****A descriptor is required.**

A.3 Drainage

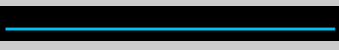







DRAINAGE			
Feature Code	Description	Descriptor (if applicable)	Graphic(s)
ABUT	Bridge Abutment		-----
See A.14.9 Bridge Photo 1 , A.14.10 Bridge Photo 2 , A.14.11 and Bridge Photo 3 for more details.			
			
APRON**	Paved Apron	APRON=APRON	CONC. APRON -----
[CONC. APRON]			
			
BEAM	Bridge Bottom Beam		LOW CHR= 523.64 -----
<i>BEAM is the bottom of the low beam on a bridge.</i>			
			

DRAINAGE			
Feature Code	Description	Descriptor (if applicable)	Graphic(s)
BRI**	Bridge	BRI=4 SPAN CONC. BRIDGE	
<p><i>[4 SPAN CONC. BRIDGE, 1 SPAN WOOD BRIDGE, 3 SPAN STEEL TRUSS BRIDGE, 3 SPAN CONC. ARCH BRIDGE] Locate the 4 outermost corners of the bridge. This will draw lines along the back edges of the abutments (not the “face” of the abutment), and along the outside edges of the sides of the bridge. If the bridge is in a curve, or is chorded, then more points will have to be located along the sides in order to draw that shape. The descriptor is: the number of spans, the material(s) the bridge is made of, and the word BRIDGE. In general, no BL’s or RD’s or SH’s go onto the bridge deck.</i></p>			
The Outer Edges		The Back Edge of the Abutments	
			
			
CRK**	Creek	CRK=LITTLE FORK CREEK	
<p><i>Locate both the edges of the water in a creek, or a single creek line if there is little water width or if the creek bed is dry. BL’s need to be located to make a correct DTM within the creek area, and CRKB and TB lines need to be located in streams where a bridge survey will be required. Use BL to do roadside ditches. See A.14.8 Creek Photo 1 for more details. A descriptor is required if the creek has a name, or if some creek detail needs noting.</i></p>			





DRAINAGE			
Feature Code	Description	Descriptor (if applicable)	Graphic(s)
CRKB	Creek Bed		
<p>Use CRKB in a creek or a river. TB is used <u>only when doing a bridge survey</u>. Locate the lowest flow line. If there were just a trickle of water, it would flow in the CRKB line. See A.14.8 Creek Photo 1 for more details.</p>			
CV**	Culvert	CV=12'X7.5' CONC. BOX CULV.	
<p>[3 @ 5'x4' CONC. BOX CULV., 10.5' x 4.8' CONC. BOX CULV.] List the number of openings (if more than one), span (width), height, and type. If the total span(s) length is over 20', use the Feature Code BRI. See A.14.6 Box Culvert Photo 1 for more details.</p>			
DAM**	Dam	DAM=HOOVER DAM	
<p>[DAM, WEIR] A dam runs across or through a body of water and can have water on both sides of it. Its main purpose is to retain water. Locate beaver dams that obstruct the flow of water. Also locate Spillways and lowest spillway elevation (see SPILL code.)</p>			
DECK	Bridge Deck Breaklines		
<p>Locate DECK lines for the length of the bridge. Locate one in the center, and one at each traveled way line. If there is a curb/sidewalk on the sides, locate DECK lines at the bottom and the top of the curb. Locate a DECK line at the bridge rail. Deck lines will not be breaklines for creating a DTM from Geopak elements. A separate DTM of the deck can be created by drawing just these DECK lines in an empty DGN file, and then in Geopak do an EXTRACT GRAPHICS to create the TIN file.</p>			



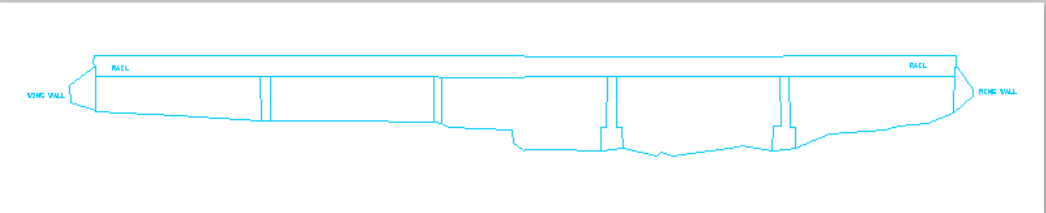
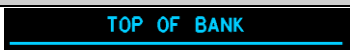

DRAINAGE			
Feature Code	Description	Descriptor (if applicable)	Graphic(s)
DIT**	Paved Ditch	DIT=CONC. DITCH	
<p><i>[CONC. DITCH, RIP-RAP DITCH] DIT is only used to locate a man-made ditch with a concrete, rip-rap, or other manmade bottom. Locate both sides of the ditch as DIT code and locate at least one breakline between them with the BL code.</i></p>			
			
DOWN	Downstream Flood Section		
EW	End Wall		
<p><i>Locate the face of the end wall at the bottom of the end wall. If the slope of the ground changes along the length of the end wall, locate additional points for this. For the top breakline, locate just one BL on the ground in back of the top of the end wall. See A.14.6 Box Culvert Photo 1 for details.</i></p>			
GAGE**	Stream Gauge	GAGE=STREAM GAUGE	
<p><i>[STREAM GAUGE] Locate the approximate shape of the gauge.</i></p>			
Staff Gauge	Wire Gauge	Vertical Pipe Gauge	
			

DRAINAGE			
Feature Code	Description	Descriptor (if applicable)	Graphic(s)
LAKE**	Lake	LAKE=PLEASANT LAKE	PLEASANT LAKE
<i>[LAKE] Locate the edge of the water.</i>			
LEVEE**	Levee	LEVEE=LEVEE	LEVEE
<i>[LEVEE] A levee runs along or parallel to a body of water such as river. It only operates to restrict water in times of high flow. Most of the time a levee is not submerged. Digitize the outline of the levee (along toe of slopes). Breaklines will be required within and along the levee.</i>			
PIER	Bridge Pier		
<i>PIER is used for bridge piers and bridge bents. A bridge Pier is located in water. A bridge Bent is located on land. Locate the shape of the pier/bent at ground elevation. See A.14.9 Bridge Photo 1 for details.</i>			
PIPE**	Pipe	PIPE=18" CMP	18" CMP
<i>[18" CMP, 24" RCP, 18" PLASTIC, 6" TRENCH DRAIN] Locate the invert at both ends of the pipe. Do not use pipe for enclosed / underground storm sewer pipe inverts.</i>			
<ul style="list-style-type: none"> • PIPE (round) – List the size, the type (example: 30" RCP). • PIPE (oval) – For the size of an oval, list the span (width) first (example: 36"x24" RCP). 			
<div style="display: flex; justify-content: space-around; align-items: flex-start;"> <div style="text-align: center;"> <p>PIPE=54"x36" RCP</p> <p>36"</p> <p>54"</p> </div> <div style="text-align: center;"> <p>PIPE=36" RCP</p> </div> <div style="text-align: center;"> <p>PIPE=6" TRENCH DRAIN</p> </div> </div>			

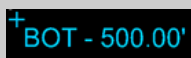

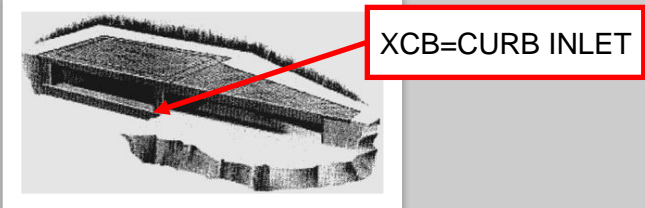
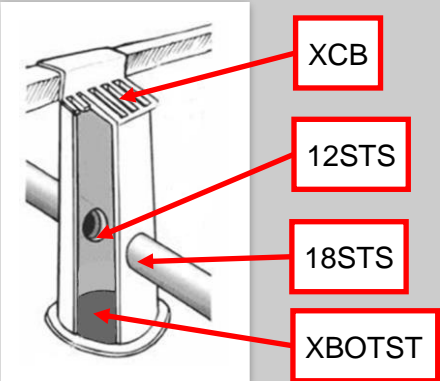

DRAINAGE			
Feature Code	Description	Descriptor (if applicable)	Graphic(s)
POND**	Pond	POND=POND	
<i>[POND] Locate the edge of the water.</i>			
RIVER**	River	RIVER=TENNESSEE RIVER	
<i>[RIVER] Locate the edge of the water.</i>			
RPDS**	Rapids / Waterfall	RPDS=RAPIDS	
<i>[RAPIDS] Locate rapids/waterfalls at the nearest safe location with a descriptor further specifying the footprint / location.</i>			
RRAP**	Rip-Rap	RRAP=CONC. RIP-RAP	
<i>[RIP-RAP] Outline areas of rip-rap and close as a shape.</i>			
<div style="display: flex; justify-content: space-around;">   </div>			
SINK	Sinkhole		
<i>Locate all around the boundary of the sink hole. The drawing should show the line's ticks pointing toward the center of the sink hole.</i>			
SPILL**	Spillway	SPILL=SPILLWAY	
<i>[SPILLWAY]</i>			
?STS	Storm Sewer		
<i>The "?" means to enter the size (diameter, in inches) of the line. Locate the invert at both ends of the line. See Feature Code XCB for more details. Use STS for any enclosed drainage system.</i>			

Appendix A. TDOT Survey Feature Codes

DRAINAGE			
Feature Code	Description	Descriptor (if applicable)	Graphic(s)
SKE	Bridge Sketch		
<i>SKE draws a vertical view of the openings under a bridge. In the office, this sketch is labeled with horizontal and vertical dimensions.</i>			
<div style="display: flex; justify-content: space-around;">   </div>			
TB**	Top Of Bank	TB=TOP OF BANK	
<i>[TOP OF BANK] TB is used to locate the top banks of a creek or river. It is not used for other tops of banks. See A.14.8 Creek Photo 1 for details.</i>			
UP	Upstream Flood Section		
WET	Wetland Boundary		
<i>Locate all around the boundary of the wetland. The drawing should show the line's vegetation marks pointing toward the center of the wetland.</i>			
XBOTST	Bottom of Storm MH, CB, etc.		
<i>See Feature Code XCB for more details.</i>			



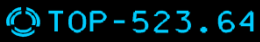
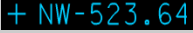



DRAINAGE			
Feature Code	Description	Descriptor (if applicable)	Graphic(s)
XCB	Catch Basin		
<i>[2 GRATES, NO GRATE] A descriptor is required if there is no grate, or if there is more than one grate.</i>			
<div style="display: flex; justify-content: space-around; align-items: flex-start;"> <div style="text-align: center;">  </div> <div style="text-align: center;">  </div> <div style="text-align: center;">  </div> </div> <div style="text-align: center;">  </div>			
XDECK**	Bridge Deck	XDECK=BORE HOLE	
<i>[WEEP HOLE, BORE HOLE] XDECK is used for individual points on a bridge deck. A descriptor is required if the point is used for more than just a DTM spot point.</i>			
			

Appendix A. TDOT Survey Feature Codes

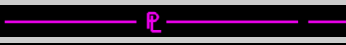

DRAINAGE			
Feature Code	Description	Descriptor (if applicable)	Graphic(s)
XDI	Drop Inlet		
<i>A drop inlet is a concrete or stone “box” at the inlet end of a pipe. Its purpose is to keep dirt out of the pipe. When it is far enough from a road, so it won’t be dangerous to traffic, no grate is necessary.</i>			
XHW	High Water Elevation Point		
<i>When doing a bridge survey, locate a point, near the bridge site, which is at the highest flooding elevation. Note the source of the elevation and year. Ex. XHW=Mudline, XHW=Local Farmer Hearsay.</i>			
XMHSTS	Storm Sewer Manhole		
<i>Locate the center top of the manhole.</i>			
XNW	Normal Water Elev. Point		
<i>When doing a bridge survey, locate a point, near the bridge site, which is at an elevation the stream flows at most of the time.</i>			
XOHW	Ordinary High Water Elevation		
<i>To be determined by Environmental Office.</i>			
XSPRING	Spring		
<i>In the drawing, rotate the symbol to point in the direction of water flow.</i>			



****A descriptor is required.**

A.4 R.O.W. / Property

R.O.W. / PROPERTY			
Feature Code	Description	Descriptor (if applicable)	Graphic(s)
ESMT**	Easement	ESMT=UTILITY ESMT.	
<i>[20' WATER ESMT.] ESMT is for office use.</i>			
ESMTD**	Drainage Easement	ESMTD=DRAINAGE ESMT.	
<i>[20' DRAINAGE EASEMENT] ESMTD is for office use.</i>			
PARCEL	Parcels		
<i>PARCEL is for office use, when making parcels.</i>			
PL	Property Line		
<i>PL is for office use, when making property lines.</i>			
PLWF	Property Line w/ Fence		
<i>PLWF is for office use, when making property lines.</i>			
ROW	ROW Line		
<i>ROW is for office use, when making Present Right Of Way lines.</i>			
ROWWF	ROW w/ Fence		
<i>The ROWWF is for office use, when making Present Right Of Way lines.</i>			
XIP**	Iron Pin Existing	XIP=AXLE	
<i>[AXLE, PIPE, ROD] Locate the center of the pin, where it enters the ground. Describe the type of property corner including the information from the rod cap if applicable.</i>			

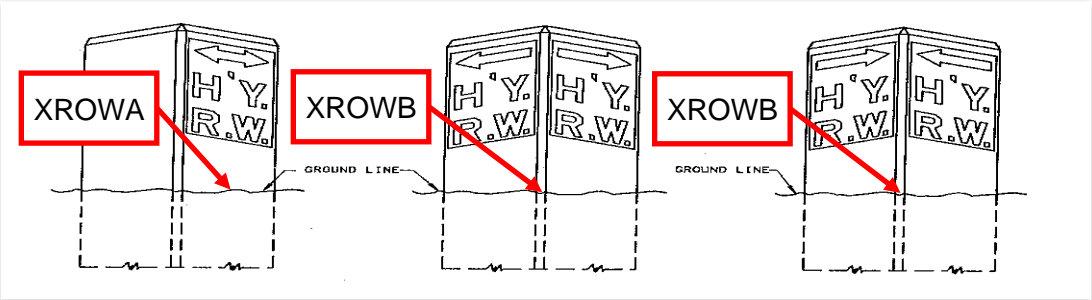
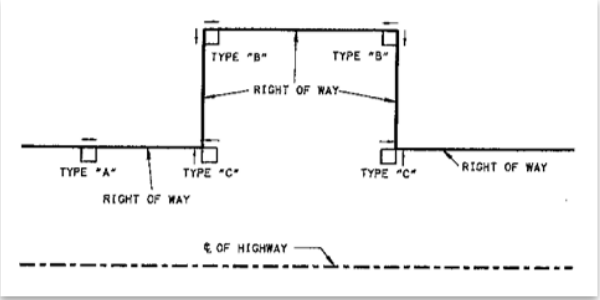
Appendix A. TDOT Survey Feature Codes



R.O.W. / PROPERTY			
Feature Code	Description	Descriptor (if applicable)	Graphic(s)
XMON**	Concrete Marker	XMON=CONC.	
<i>XMON is <u>not</u> a highway ROW monument. It is a monument usually found at a property corner. Locate the center of the monument. Describe the size and any markings present.</i>			
			
XPL**	Property Corner	XPL=PILE OF STONES	o PILE OF STONES
<i>Use this code for all other property line monumentation. Locate the center of the corner point.</i>			
XROW	R.O.W. Monument		
<i>XROW is Type "A". It is the same as Feature Code XROWA.</i>			
			
			

R.O.W. / PROPERTY			
Feature Code	Description	Descriptor (if applicable)	Graphic(s)
XROWA	R.O.W. Monument (Inline)		
<i>XROWA is the same as Feature Code XROW; the origin of the cell is the middle of one side of the square. See Feature Code XROW for details.</i>			
XROWB	R.O.W. Monument (Corner)		
<i>XROWB is for ROW monument Types "B" and "C"; the origin of the Microstation cell is a corner of the square. See Feature Code XROW for details.</i>			



****A descriptor is required.**

A.5 Political Boundaries





Political boundary features are created by office staff from maps and collected field evidence. Label the state, county and/or city on their respective side of the line.

POLITICAL BOUNDARIES			
Feature Code	Description	Descriptor (if applicable)	Graphic(s)
CITY	City Limits		
COUNTY	County Line		
STATE	State Line		



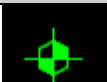

A.6 Utilities



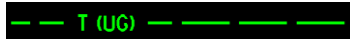

UTILITIES			
Feature Code	Description	Descriptor (if applicable)	Graphic(s)
?GL	Gas Line		
<p>The “?” means to enter the size (diameter, in inches) of the line. Note: Typically the gas line is located on the ground surface where it has been marked. If the utility owner does not know the actual depth of the gas line, then it should be vertically offset -2 feet by default in the office and noted as such.</p>			
OHW	Overhead Wire		
<p>OHW is <u>only</u> used when an overhead utility wire crosses a survey centerline. Locate the end points of this line at the two poles involved. The linestyle in Open Roads Designer draws a stub on each end of the line, and the rest of the line is not visible. An XLW point must be located in conjunction with this line. See Feature Code XLW, A.14.13 Utility Photo 1 and A.14.14 Utility Photo 2 for details.</p>			
PTOW	Transmission Tower		
<p>Locate all 4 tower legs at ground elevation. This will draw an approximate square shape. In the office, draw diagonal lines within the square. These lines can also be drawn by the crew in the field.</p>			
<div style="display: flex; align-items: center;">   </div>			
?SAS	Sanitary Sewer		
<p>The “?” means to enter the size (diameter, in inches) of the line. Locate the invert at both ends of the line.</p>			



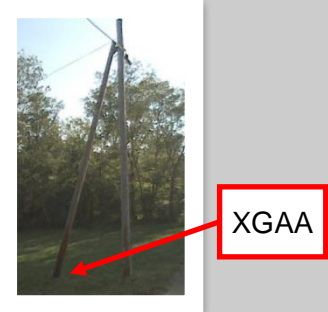

UTILITIES			
Feature Code	Description	Descriptor (if applicable)	Graphic(s)
?FMS	Force Main Sanitary Sewer		
<i>The “?” means to enter the size (diameter, in inches) of the line. Note: Typically the force main sewer is located on the ground surface where it has been marked. If the utility owner does not know the actual depth of the force main sewer, then it should be vertically offset -3 feet by default in the office and noted as such.</i>			
XBOTSA	Bottom of Sanitary MH		
<i>XBOTSA is for locating the bottom elevation of a sanitary sewer manhole.</i>			
XCA**	SUE Utility Cable Point	XCA=6" duct bank_AthensCable_2.1' deep	
<i>XCA is for SUE Quality level A where the underground utility has been exposed so its location can be measured directly. A descriptor is required for office labeling. Include size, material, owner, and depth to top of line.</i>			
XEA**	SUE Utility Electric Point	XEA=2" PVC Conduit_Lighting_1.8' deep	
<i>XEA is for SUE Quality level A where the underground utility has been exposed so its location can be measured directly. A descriptor is required for office labeling. Include size, material, owner, and depth to top of line.</i>			
XFOA**	SUE Utility Fiber Optic Point	XFOA=3" PVC_CarterCo_3.3'deep	
<i>XFOA is for SUE Quality level A where the underground utility has been exposed so its location can be measured directly. A descriptor is required for office labeling. Include size, material, owner, and depth to top of line.</i>			
XFMA**	SUE Utility Force Main Point	XFMA=4" DIP_VincentTN_at surface	
<i>XFMA is for SUE Quality level A where the underground utility has been exposed so its location can be measured directly. A descriptor is required for office labeling. Include size, material, owner, and depth to top of line.</i>			

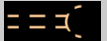

UTILITIES			
Feature Code	Description	Descriptor (if applicable)	Graphic(s)
XGA**	SUE Utility Gas Point	XGA=8" Steel_fuel_Avgas_6.8'deep	
<i>XGA is for SUE Quality level A where the underground utility has been exposed so its location can be measured directly. A descriptor is required for office labeling. Include size, material, owner, and depth to top of line.</i>			
XTA**	SUE Utility Telephone Point	XTA=0.5" direct buried line_BellNorth_0.9'deep	
<i>XTA is for SUE Quality level A where the underground utility has been exposed so its location can be measured directly. A descriptor is required for office labeling. Include size, material, owner, and depth to top of line.</i>			
XWA**	SUE Utility Water Point	XWA=16" DIP_WestcoWater_12.6'deep	
<i>XWA is for SUE Quality level A where the underground utility has been exposed so its location can be measured directly. A descriptor is required for office labeling. Include size, material, owner, and depth to top of line.</i>			
UGC	Cable (UG)		
<i>Note: Typically underground cable is located on the ground surface where it has been marked. If the utility owner does not know the actual depth of the cable, then it should be vertically offset -1.5 feet by default in the office and noted as such.</i>			
UGF	Fiber Optic (UG)		
<i>Note: Typically underground fiber is located on the ground surface where it has been marked. If the utility owner does not know the actual depth of the fiber, then it should be vertically offset -1.5 feet by default in the office and noted as such.</i>			
UGP	Power (UG)		
<i>Note: Typically underground power is located on the ground surface where it has been marked. If the utility owner does not know the actual depth of the power, then it should be vertically offset -1.5 feet by default in the office and noted as such.</i>			

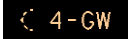
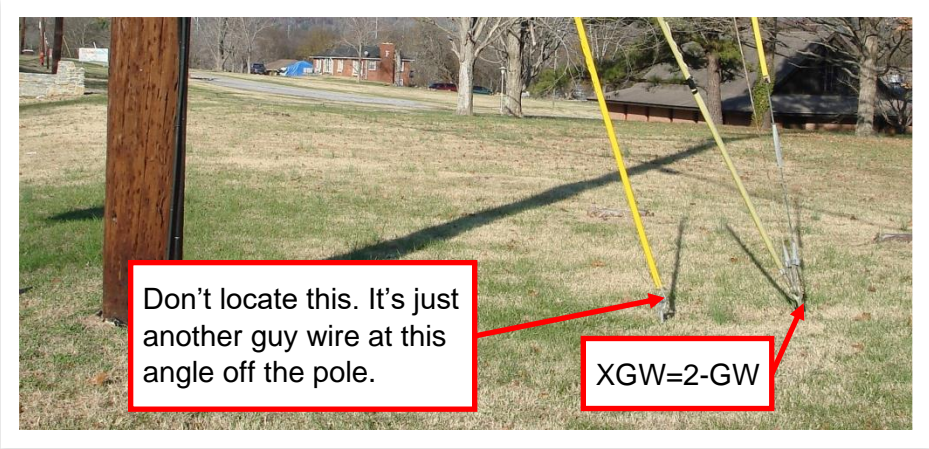

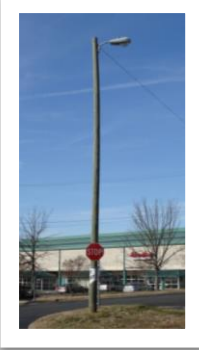

Appendix A. TDOT Survey Feature Codes

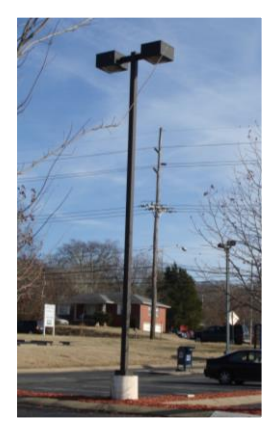
UTILITIES			
Feature Code	Description	Descriptor (if applicable)	Graphic(s)
UGT	Telephone (UG)		
<i>Note: Typically underground telephone is located on the ground surface where it has been marked. If the utility owner does not know the actual depth of the telephone, then it should be vertically offset -1.5 feet by default in the office and noted as such.</i>			
?WL	Water Line		
<i>The "?" means to enter the size (diameter, in inches) of the line. Note: Typically the water line is located on the ground surface where it has been marked. If the utility owner does not know the actual depth of the water line, then it should be vertically offset -2.5 feet by default in the office and noted as such.</i>			
XFH	Fire Hydrant		
<i>Locate the center of the fire hydrant at ground elevation.</i>			
			
XGAA	Guy Device Angle Anchor		
<i>XGAA is a "device", like a pole. <u>It is not a wire.</u> In the office, rotate the symbol so the line is toward the pole.</i>			



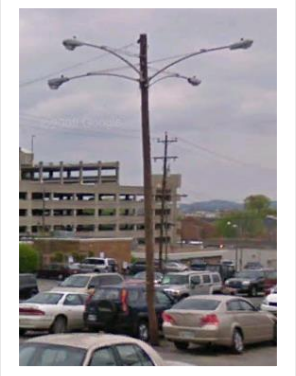

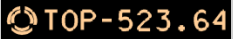

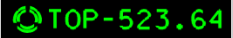
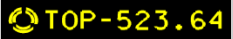

UTILITIES			
Feature Code	Description	Descriptor (if applicable)	Graphic(s)
XGAA	Guy Device Angle Anchor		
<p><i>XGAA is a “device”, like a pole. <u>It is not a wire.</u> In the office, rotate the symbol so the line is toward the pole.</i></p>			
			
XGM	Gas Meter		
XGV	Gas Valve		
<p><i>Locate the center of the valve lid at ground level. If possible, note the depth from the lid to the top of the inline valve below.</i></p>			
XGVA	Guy Device Vertical Anchor		
<p><i>XGVA is a “device”, like a pole. <u>It is not a wire.</u> In the office, rotate the symbol so the line is toward the pole.</i></p>			
			

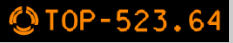
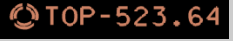



UTILITIES			
Feature Code	Description	Descriptor (if applicable)	Graphic(s)
XGW**	Guy Wire	XGW=4-GW	
<p><i>[2-GW, 3-GW, 4-GW] XGW is for locating guy wires. When there's only one guy anchor point, no descriptor is needed. With more than one at the <u>same angle</u> from a pole, locate the one furthest from the pole, and use a descriptor. In the office, rotate the symbol so the stub is toward the pole.</i></p>			
<div style="display: flex; align-items: center;">  </div>			
XLP1	Light Pole 1 Light		
<p><i>XLP1 is just a light pole. There are no utility lines going to this pole, except the electric line for the light.</i></p>			
<div style="display: flex; gap: 20px;">   </div>			





UTILITIES			
Feature Code	Description	Descriptor (if applicable)	Graphic(s)
XLP2	Light Pole 2 Lights		
<i>XLP2 is just a light pole. There are no utility lines going to this pole, except the electric line for the light.</i>			
			
XLP3	Light Pole 3 Lights		
<i>XLP3 is just a light pole. There are no utility lines going to this pole, except the electric line for the light.</i>			
			





UTILITIES			
Feature Code	Description	Descriptor (if applicable)	Graphic(s)
XLP4	Light Pole 4 Lights		
<i>XLP4 is just a light pole. There are no utility lines going to this pole, except the electric line for the light.</i>			
			
XLW**	Low Wire Crossing	XLW=8P-86DEG	
<i>[3P2T1C, 8P-86DEG] Locate an XLW point where an overhead utility wire crosses a survey centerline, at the elevation of the wire. Don't use XLW for a service line. Use the descriptor to specify how many Power, Telephone, and Cable wires there are, and the temperature (for high-tension power lines only). An OHW line must be located in conjunction with this point. See Feature Code OHW, A.14.13 Utility Photo 1 and A.14.14 Utility Photo 2 for details.</i>			
XMH**	Manhole	XMH=UNKNOWN	
<i>[UNKNOWN] XMH is used when the type of the manhole is unknown or for other manholes without a feature code in this document. Locate the center top of the manhole.</i>			
XMHC	Cable Manhole		
<i>Locate the center top of the manhole.</i>			
XMHF	Fiber Optic Manhole		
<i>Locate the center top of the manhole.</i>			
XMHG	Gas Manhole		
<i>Locate the center top of the manhole.</i>			

Appendix A. TDOT Survey Feature Codes





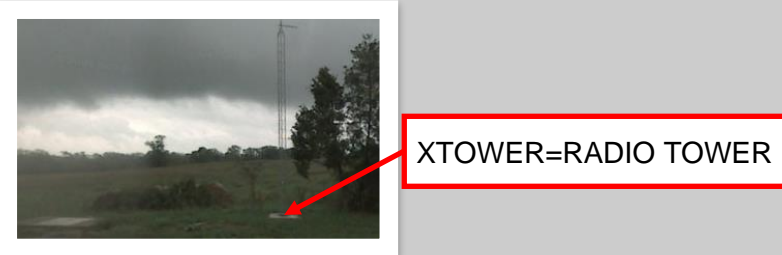

UTILITIES			
Feature Code	Description	Descriptor (if applicable)	Graphic(s)
XMHP	Power Manhole		
<i>Locate the center top of the manhole.</i>			
XMHSAS	Sanitary Sewer Manhole		
<i>Locate the center top of the manhole.</i>			
XSM	Sanitary Sewer Meter		
XSV	Sanitary Sewer Valve		
<i>XSV is a valve in a force main sanitary sewer. Locate the center of the valve lid at ground level. If possible note the depth from the lid to the top of the inline valve below.</i>			
XUM**	Misc. Utility Feature	XUM=GAS LINE MARKER	
<i>[GAS LINE MARKER]</i>			
XMHT	Telephone Manhole		
<i>Locate the center top of the manhole.</i>			
XMHW	Water Manhole		
<i>Locate the center top of the manhole.</i>			
XPB**	Utility Boxes (pull box)	XPB=CABLE	
<i>[TELE., CABLE, FIBER OPTIC] Use XPB for utility pull boxes not traffic signal pull boxes. Use XPULLB for pull boxes associated with traffic control signal systems.</i>			
XUP**	Utility Pole	XUP=P/T/C	
<i>[P, P/T, P/T/C, ITS RADAR, ITS CAMERA] Locate pole at ground elevation. A descriptor must be used to show the types of wires attached to the pole (Power, Telephone, Cable). See A.14.13 Utility Photo 1 and A.14.14 Utility Photo 2 for details.</i>			

UTILITIES			
Feature Code	Description	Descriptor (if applicable)	Graphic(s)
XUPL**	Utility Pole with Light	XUPL=P/T/C	
<p><i>[P, P/T, P/T/C, P/T 4-LIGHTS] Locate pole at ground elevation. A descriptor must be used to show the types of wires attached to the pole, and if there is more than one light. On the drawing, rotate the symbol to show the light facing the correct way.</i></p>			
			
XHMPLH	High Mast Light (half)		
<p><i>Locate the center of the utility pole at ground elevation.</i></p>			
			

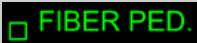
UTILITIES			
Feature Code	Description	Descriptor (if applicable)	Graphic(s)
XHMPLF	High Mast Light (full)		
<i>Locate the center of the utility pole at ground elevation.</i>			
			
XLCC	Lighting Control Center		
<i>Locate the center of the box.</i>			
			
XEV	Electric Vehicle Charging Station		
<i>Locate at the face of the charging station at ground elevation.</i>			

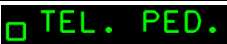



UTILITIES			
Feature Code	Description	Descriptor (if applicable)	Graphic(s)
XTBOX	Telephone Box		
			
XTOWER**	Radio / TV Tower	XTOWER=RADIO TOWER	
<p><i>[RADIO TOWER, ITS WEATHER TOWER] Only use this spot tower code for the center of towers where the legs are less than 5 feet apart.</i></p>			
			
XC PED	Cable Pedestal		
<p><i>Locate at ground elevation. Describe with the owner of the pedestal if available.</i></p>			
			

Appendix A. TDOT Survey Feature Codes

UTILITIES			
Feature Code	Description	Descriptor (if applicable)	Graphic(s)
XFPED	Fiber-Optic Pedestal		
<i>Locate the center, at ground elevation. Describe with the owner of the pedestal if available.</i>			
			
XTPED	Telephone Pedestal		
<i>Locate at ground elevation. Describe with the owner of the pedestal if available.</i>			
			
XWM^{^^}	Water Meter	XWM=4meters	
<i>[4-] Locate the center of the water meter. If there is more than one water meter within a few feet of each other, locate a center point between them, and use a descriptor of the number of meters. In the office, move and rotate the descriptor to be next to the "W.M."</i>			
XWV	Water Valve		
<i>Locate the center of the valve lid at ground level. If possible, note the depth from the lid to the top of the inline valve below.</i>			
UM^{**}	Misc. Utility Line	UM=TRANSFORMER & PAD	
<i>[TRANSFORMER & PAD]</i>			

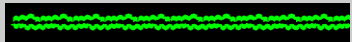
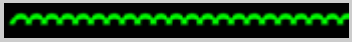





****** A descriptor is required. **^^** A descriptor is optional.





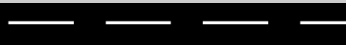

A.7 Vegetation







VEGETATION			
Feature Code	Description	Descriptor (if applicable)	Graphic(s)
HEDGE	Hedge Line		
<i>Locate the centerline of the hedge at ground elevation.</i>			
TREE	Tree Drip Line		
<i>Locate the outer edge of the tree limbs in a wooded area at ground elevation.</i>			
XBUSH	Bush		
<i>Locate the center of the bush at ground elevation. If many bushes are aligned together, use hedge line.</i>			
XTREES**	Small Tree (0"-6" diameter)		
<i>Locate the center of the tree at ground elevation. The descriptor is the diameter of the tree about 4' above the ground, followed by the type of tree.</i>			
XTREEM**	Medium Tree (6"-12" diameter)		
<i>Locate the center of the tree at ground elevation. The descriptor is the diameter of the tree about 4' above the ground, followed by the type of tree.</i>			
XTREEL**	Large Tree (12+ diameter)		
<i>Locate the center of the tree at ground elevation. The descriptor is the diameter of the tree about 4' above the ground, followed by the type of tree.</i>			

**** A descriptor is required.**





A.8 Traffic Control

TRAFFIC CONTROL			
Feature Code	Description	Descriptor (if applicable)	Graphic(s)
BARR**	Barricade	BARR=BARRICADE	
<i>[BARRICADE]</i>			
			
LDECT**	Loop Detector	LDECT=LOOP DETECTOR	
<i>[LOOP DETECTOR] The loop detectors are in pavement cuts and are in all the lanes.</i>			
			
LLD	Lane Line Dashed		
LLDS	Lane Line Dashed Short		
LLS	Lane Line Solid		
<i>Use LLS to locate lane lines and parking stripes. See A.14.3 Road Photo 5 for details.</i>			



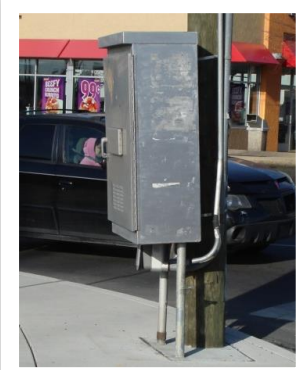
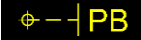



TRAFFIC CONTROL			
Feature Code	Description	Descriptor (if applicable)	Graphic(s)
SIGNT**	Transportation Sign	SIGNT=SIGN	
<p><i>[SIGN, OVERHEAD SIGN, CANTILEVER SIGN] SIGNT is for wide signs that are part of the transportation system. Do not describe what is written on the sign. If the sign is not wide, use Feature Code XSIGN1, XSIGN2, or X2SIGN.</i></p>			
<div style="display: flex; justify-content: space-around;"> <div style="text-align: center;">  <p>+SIGNT=SIGN</p> <p>-SIGNT</p> </div> <div style="text-align: center;">  <p>+SIGNT=OVERHEAD SIGN</p> <p>+SIGNT=CANTILEVER SIGN</p> <p>-SIGNT</p> </div> <div style="text-align: center;">  <p>-SIGNT</p> </div> </div>			
XOHS**	Overhead Sign	XOHS=SCHOOL ZONE	
<p><i>[SCHOOL ZONE] XOHS is used for small overhead signs. Locate at the lowest edge of the sign.</i></p>			
<div style="text-align: center;">  <p>XOHS=SCHOOL ZONE</p> </div>			

TRAFFIC CONTROL			
Feature Code	Description	Descriptor (if applicable)	Graphic(s)
XPDMC	Pad Mounted Controller		
<i>The box contains controls for a traffic signal.</i>			
			
XPDSHN	Pedestrian Signal		
<i>Locate the center of the signal at ground elevation. In the office, point the arrow the way the light faces.</i>			
			



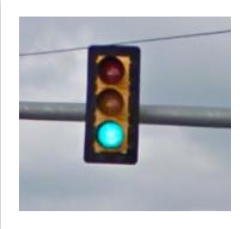

XPDSHN

TRAFFIC CONTROL			
Feature Code	Description	Descriptor (if applicable)	Graphic(s)
XPLMC	Pole Mounted Controller		
<i>The box contains controls for a traffic signal.</i>			
			
XPPH	Pedestrian Pushbutton	Use XPPH on standalone pedestrian pushbuttons as well	
			
XPULLB	Pull Box		
<i>Use XPULLB for pull boxes associated with traffic control signal systems not utility pull boxes. Use XPB for utility pull boxes.</i>			

TRAFFIC CONTROL			
Feature Code	Description	Descriptor (if applicable)	Graphic(s)
XRRFS	RR Flashing Signal Crossing		
			
XRRFSG	RR Flash Sig Cross w/ Gate		
			
XRRSIG	Railroad Signal		
 			

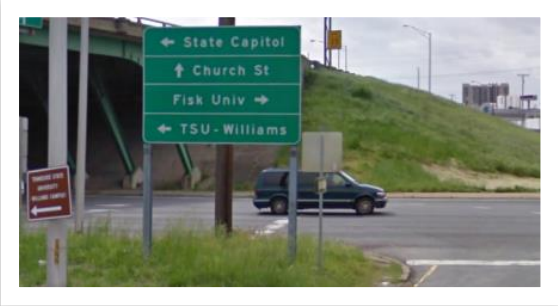





TRAFFIC CONTROL			
Feature Code	Description	Descriptor (if applicable)	Graphic(s)
XSHN	Traffic Signal Head		
			
XSHNB	Signal Head w/ Backplate		
			
XSIGN1**	Small 1-Post Sign	XSIGN1=MM3	
<p><i>Locate the center of the sign. If the face of the sign is wide, use the Feature Code SIGNT. A descriptor is required only for a mile marker sign. In the office, rotate the sign to face correctly.</i></p>			
<div style="display: flex; justify-content: space-around;"> <div style="text-align: center;">  </div> <div style="text-align: center;">  </div> </div>			







Appendix A. TDOT Survey Feature Codes



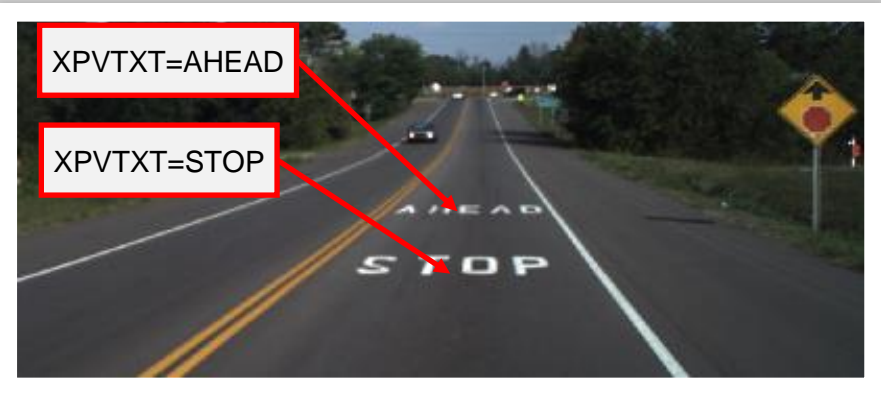





TRAFFIC CONTROL			
Feature Code	Description	Descriptor (if applicable)	Graphic(s)
XSIGN2	Small 2-Post Sign		
<p>Locate the center of the sign. It is not necessary to describe what is written on the sign. If the face of the sign is wide, use the Feature Code SIGNT.</p>			
			
X2SIGN	Small 2-Faced Sign		
XSPSS	Strainpole		
<p>Locate pole at ground elevation.</p>			
			
XWPSS	Wood Signal		
<p>Same As Feature Code XSPSS, except that the pole is wood. See Feature Code XSPSS for details.</p>			





**** A descriptor is required.**

A.9 Traffic Control (Pavement Marking)

TRAFFIC CONTROL (PAVEMENT MARKING)			
Feature Code	Description	Descriptor (if applicable)	Graphic(s)
CWALK**	Crosswalk	CWALK=CROSSWALK	CROSSWALK
<i>Locate an outline of the crosswalk area.</i>			
			
STOP	Stop Bar		
<i>See Feature Code CWALK for details. Locate the length of the stop bar down the center.</i>			
XHC	Handicap Parking		
<i>Locate Handicap parking symbol in the center.</i>			
XHOV	HOV Diamond		
<i>Locate in the center of the diamond.</i>			
XONLY	Only Pavement Marking		
<i>Locate the bottom-center of the text "ONLY" painted on the pavement.</i>			
			



TRAFFIC CONTROL (PAVEMENT MARKING)			
Feature Code	Description	Descriptor (if applicable)	Graphic(s)
XPVTEXT**	Pavement Marking Words (Center)	XPVTEXT=AHEAD	AHEAD
<i>Locate the text at the bottom-center.</i>			
			
XRRPAV	Railroad Crossing Pavement Marking		
<i>Locate in the center of the cross.</i>			
XRARI	Right Arrow Interstate		
<i>Locate at the center of the base of the arrow.</i>			
XSARI	Straight Arrow Interstate		
<i>Locate at the center of the base of the arrow.</i>			
XSRARI	Straight & Right Arrow Interstate		
<i>Locate at the center of the base of the arrow.</i>			
XLAR	Left Arrow Pavement Marking		
<i>Locate at the center of the base of the arrow.</i>			

TRAFFIC CONTROL (PAVEMENT MARKING)			
Feature Code	Description	Descriptor (if applicable)	Graphic(s)
XRAR	Right Arrow Pavement Marking		
<i>Locate at the center of the base of the arrow.</i>			
XSAR	Straight Arrow		
<i>Locate at the center of the base of the arrow.</i>			
XLRAR	Left & Right Arrow		
<i>Locate at the center of the base of the arrow.</i>			
XSLAR	Straight & Left Arrow		
<i>Locate at the center of the base of the arrow.</i>			
XSLRAR	Straight, Left & Right Arrow		
<i>Locate at the center of the base of the arrow.</i>			
XSRAR	Straight & Right Arrow		
<i>Locate at the center of the base of the arrow.</i>			
XRLAR	Roundabout Left Arrow Pavement Marking		
<i>Locate at the center of the base of the arrow.</i>			
XRSLAR	Roundabout Straight / Left Arrow Pavement Marking		
<i>Locate at the center of the base of the arrow.</i>			
XRSLRAR	Roundabout Straight / Left / Right Arrow Pavement Marking		
<i>Locate at the center of the base of the arrow.</i>			







TRAFFIC CONTROL (PAVEMENT MARKING)			
Feature Code	Description	Descriptor (if applicable)	Graphic(s)
XSUBBIKE	Bike Pavement Marking – Suburban		
<i>Locate at the tip of the arrow.</i>			
XUBIKE	Bike Pavement Marking – Urban		
<i>Locate at the tip of the arrow.</i>			
XYIELD	Pavement Yield Label		
<i>Locate at the bottom center of the word YIELD.</i>			
YIELD	Pavement Yield Line		

**** A descriptor is required.**

A.10 Terrain Model

TERRAIN MODEL			
Feature Code	Description	Descriptor (if applicable)	Graphic(s)
BL	Breakline		
<i>BL is located where the surface of the terrain “breaks” and another Feature Code will not locate it as a DTM breakline. It is used for the crown of a two-lane road, tops of banks, bottoms of banks, tops of curbs, tops of wing walls, tops of end walls, tops of abutments, bottoms of streams, bottoms of concrete and rip-rap ditches, and more.</i>			
OL	Obscure Line		
<i>OL is used in the office, mainly with an aerial survey DTM.</i>			
XP	Ground Point		
<i>XP is a spot point, for DTM creation. Spacing is approximately a 50’, or less, grid pattern, plus any extra points as needed to densify the data to create a correct DTM.</i>			

A.11 Survey Control









SURVEY CONTROL			
Feature Code	Description	Descriptor (if applicable)	Graphic(s)
XBM**	Benchmark	XBM=SPIKE IN POLE	
<i>XBM is a high-quality benchmark, set using differential leveling equipment.</i>			
XCK**	Check Point	XCK=GPS 17	
<i>[GPS 17] When using RTK (Real Time Kinetic) GPS techniques, it is necessary to check into a known point's coordinates and elevation before starting, and at the end of, data collection work. Use XCK to record that checking point. The descriptor does not have to be the full, exact, name of the point being checked into.</i>			
XCP**	Control Point	XCP=GPS 19-012-08	
<i>XCP is a high quality, 3D control point; probably set using the methods in the survey manual. It will be listed in the Control Point Table and will be drawn on the profile as a control point.</i>			
XH**	Horizontal Photo Point	XH=PIP	
<i>[PIP, CLOTH FLAG, PAINTED FLAG] XH is a Photo Control Point for an aerial survey, and only has north & east coordinates. Photo Control Points are either PIP (photo-identifiable point, like the corner of a sidewalk), or a cloth flag or a painted flag.</i>			
XHV**	Horiz & Vert Photo Point	XHV=PAINTED FLAG	
<i>[PIP, CLOTH FLAG, PAINTED FLAG] XHV is a Photo Control Point for an aerial survey, and has north & east coordinates, and elevation. Photo Control Points are either PIP (photo-identifiable point, like the corner of a sidewalk), or a cloth flag or a painted flag.</i>			
XSPUR^^	Temporary Survey Point	XSPUR=PK NAIL	
<i>XSPUR is a 3D control point that is just a spur point and is not in a closed or adjusted traverse. It will not be listed in the Control Point Table, and will not be a benchmark.</i>			
XTRAV**	Traverse Point	XTRAV=REBAR & CAP	
<i>XTRAV is a 3D control point in a closed adjusted traverse.</i>			

SURVEY CONTROL			
Feature Code	Description	Descriptor (if applicable)	Graphic(s)
XV**	Vertical Photo Point	XV=CLOTH FLAG	
<i>[PIP, CLOTH FLAG, PAINTED FLAG] XV is a Photo Control Point for an aerial survey, and only has an elevation. Photo Control Points are either PIP (photo-identifiable point, like the corner of a sidewalk), or a cloth flag or a painted flag.</i>			





** A descriptor is required. ^A descriptor is optional.

A.12 Miscellaneous & Default Codes

The six DEFAULT codes below are for drawing items that do not have a valid code. In the office, change the code on these items to one that is in the codes' list.





MISCELLANEOUS & DEFAULT CODES			
Feature Code	Description	Descriptor (if applicable)	Graphic(s)
DEFAULT_CHAIN	Default Item		
DEFAULT_CURVE	Default Item		
DEFAULT_LINE	Default Item		
DEFAULT_PARCEL	Default Item		
DEFAULT_POINT	Default Item		
DEFAULT_SPIRAL	Default Item		
DASH**	Dash Line	DASH=OLD BARBWIRE ON GROUND	
<i>The dashed line will be drawn with the Non-Transportation Features.</i>			
DOT**	Dotted Line	DOT=SEP DRAIN FLD?	
<i>The dotted line will be drawn with the Non-Transportation Features.</i>			

Appendix A. TDOT Survey Feature Codes

MISCELLANEOUS & DEFAULT CODES			
Feature Code	Description	Descriptor (if applicable)	Graphic(s)
LD**	Long Dash Line	LD=CATTLE PATH PER FARMER	
<i>The long dashed line will be drawn with the Non-Transportation Features.</i>			
MISC**	Miscellaneous	MISC=ABOVE GROUND POOL	
<i>The solid line will be drawn with the Non-Transportation Features.</i>			
SOLID**	Solid Line	SOLID=ABOVE GROUND POOL	
<i>The solid line will be drawn with the Non-Transportation Features.</i>			
XMISC**	Misc. Unknown Point	XMISC=FILLER CAP	
<i>[FILLER CAP] The circle will be drawn with the Non-Transportation Features.</i>			

****** A descriptor is required.

A.13 Office Codes

OFFICE CODES			
Feature Code	Description	Descriptor (if applicable)	Graphic(s)
CL	Proposed Centerline		+ S101 
<p><i>CL is not used in the field. In the office, use it for preliminary centerline development. It draws both points and lines.</i></p> <ul style="list-style-type: none"> Preliminary Centerline: Centerline developed by the surveyor or designer as part of the survey process. It will then be used by survey to station the applicable annotation off of, and then re-submitted to the designer as part of the survey deliverables. <p>Note: The Proposed Centerline is the preliminary centerline that is re-featurized by the designer and then carried through the design with the necessary geometric updates.</p>			
DBDRY	Drainage Map Boundary		
<p><i>For every location where there will be a structure (a pipe, a box culvert, or a bridge over water), DBDRY is for locating the complete boundary line around the drainage area for that structure. Rain water that falls within that area will end up going through the pipe or box culvert, or under the bridge. This drainage boundary line might be located in the field, in the office, or a combination of both.</i></p>			
EXCL	Existing Centerline		+ S101 
<p>EXCL is used in the office to develop the existing centerline as part of the survey process based on the field collected points. Fully label this centerline and plot its profile.</p>			
X_PROPERTY	Property Development		+ SP217 
<p><i>X_PROPERTY is used in the office for property and ROW development. It draws both points and lines.</i></p>			
XPOINT	HiVis Generic Office Point		+ SP217 
<p><i>XPOINT is used in the office for development of anything that requires COGO. It draws both points and lines.</i></p>			

A.14 Photos

A.14.1 Road Photo 1

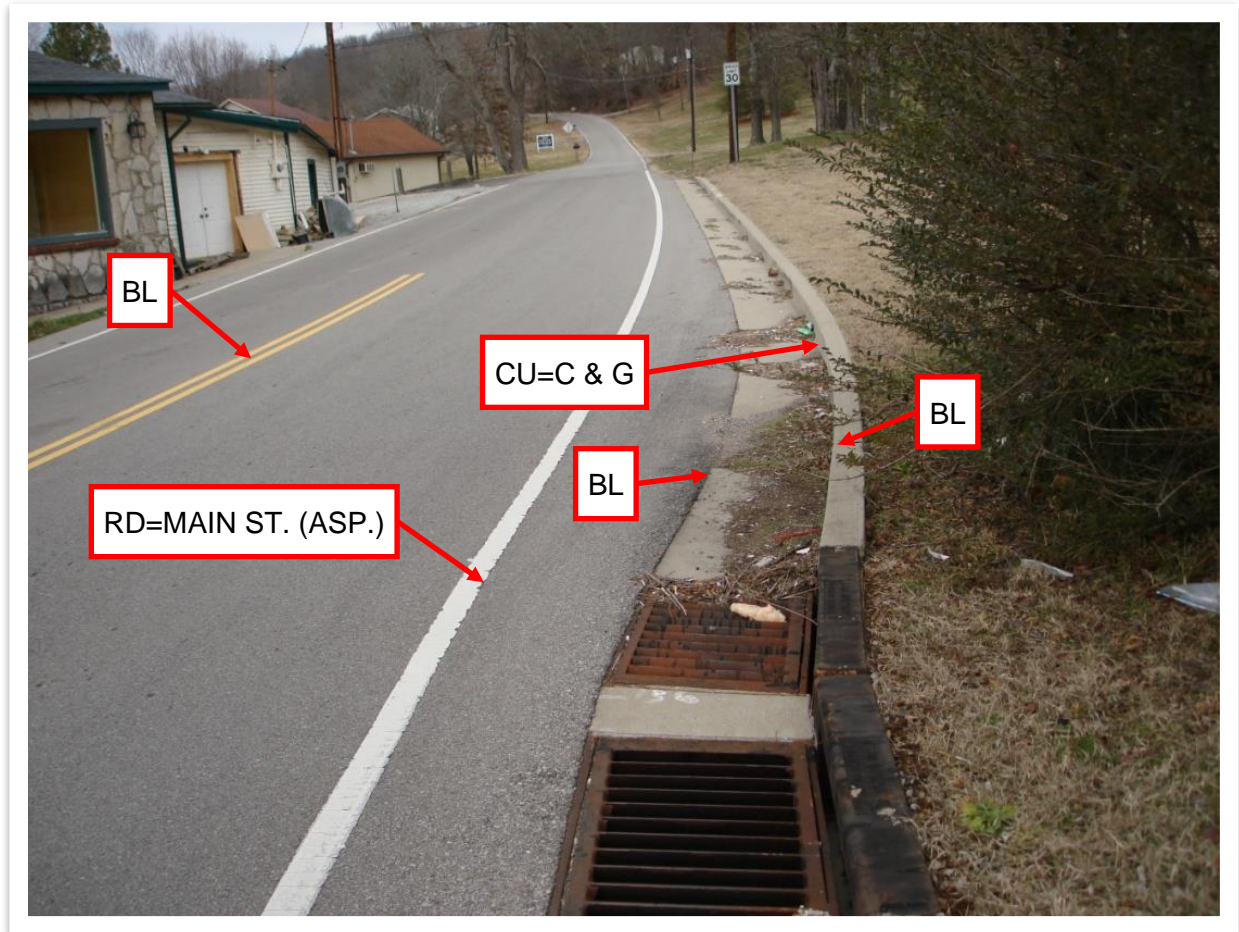

A.14.2 Road Photo 2

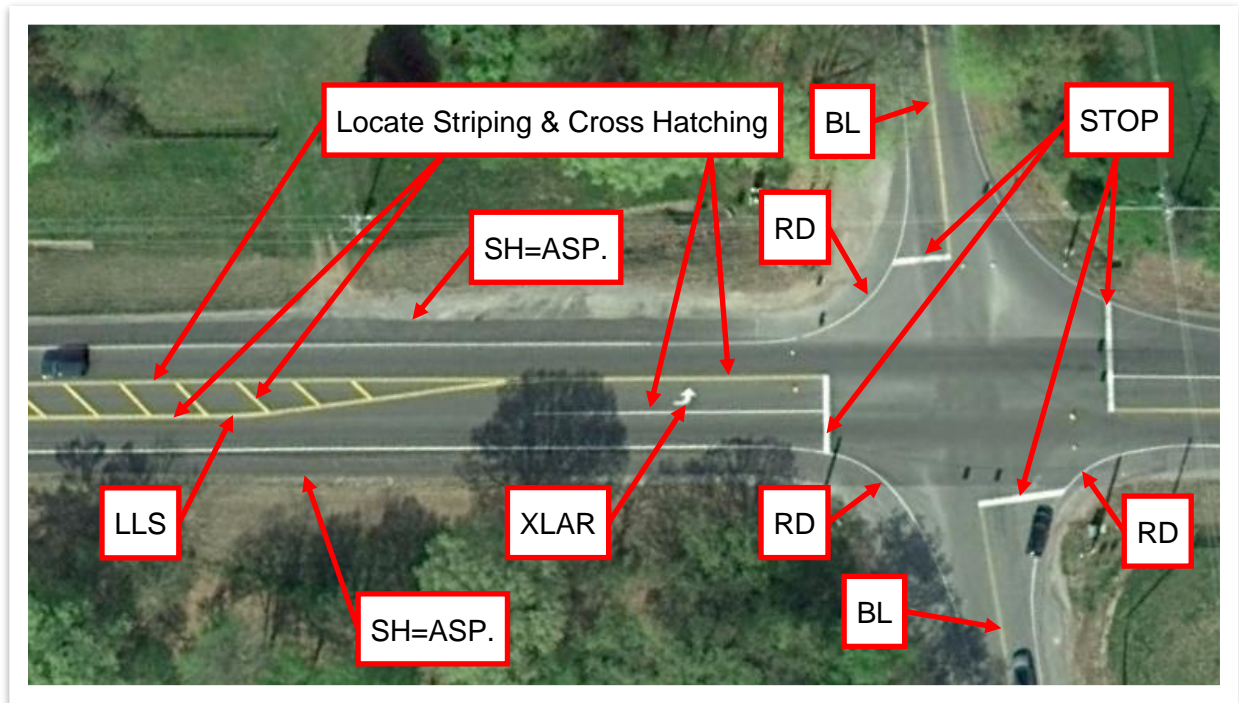

A.14.3 Road Photo 3

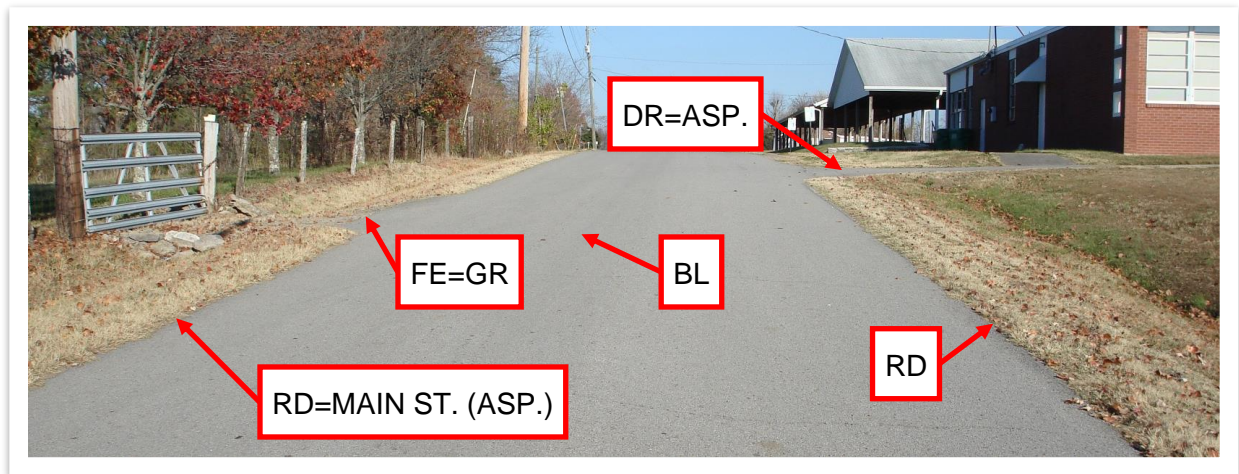

A.14.4 Road Photo 4

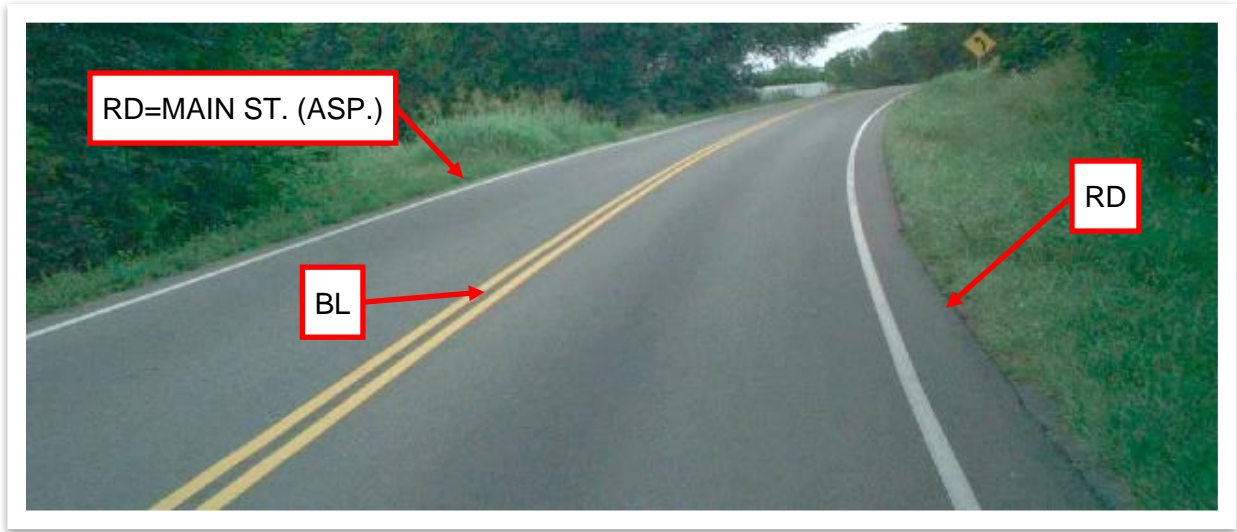

A.14.5 Road Photo 5

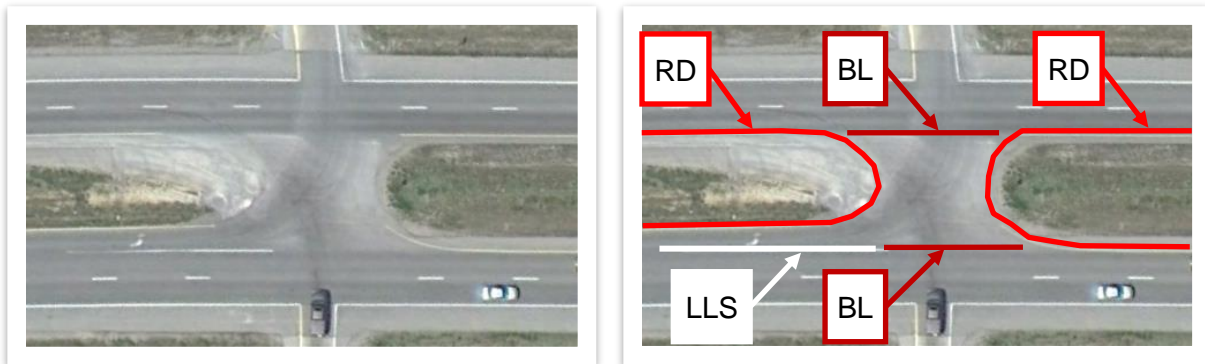

A.14.6 Box Culvert Photo 1

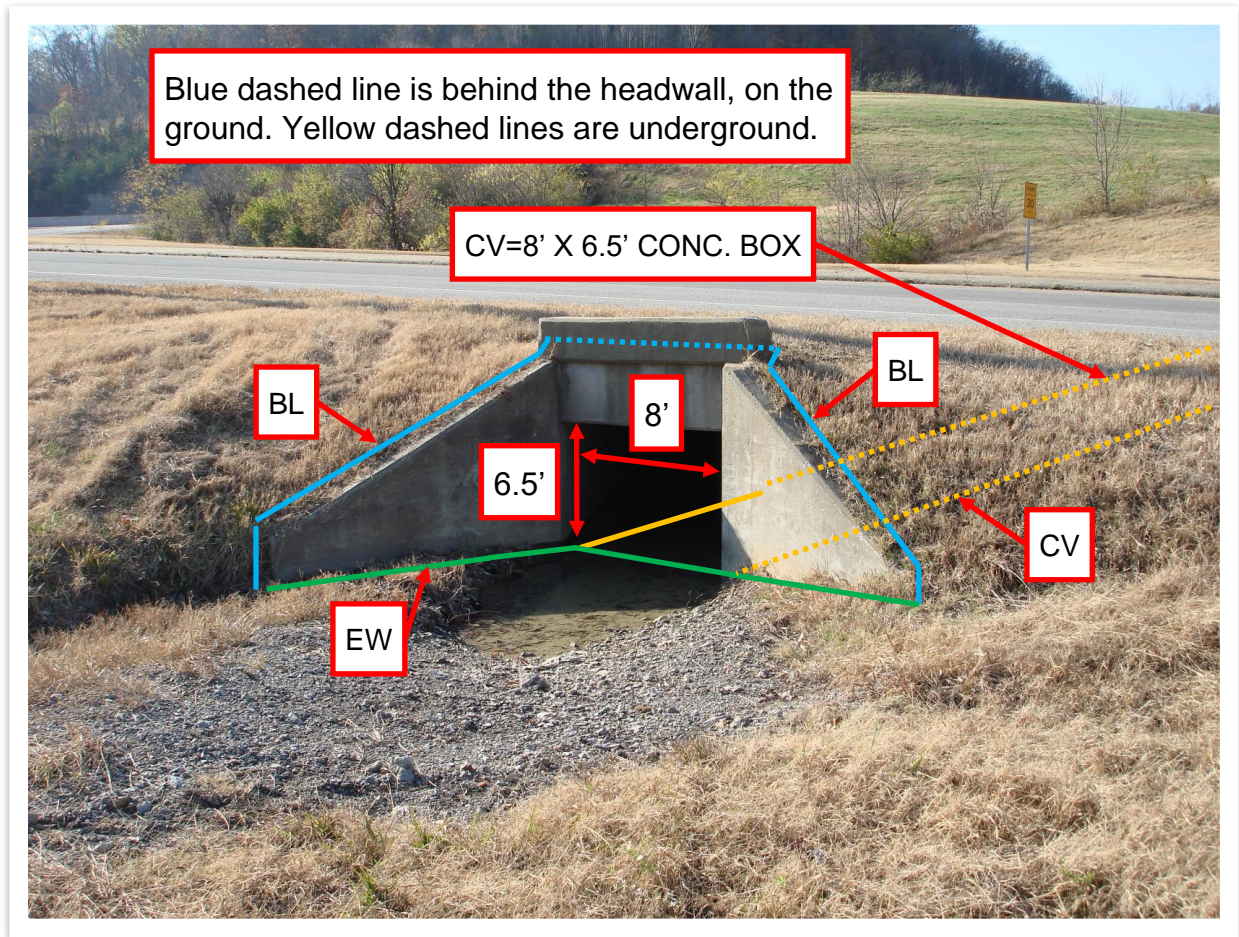

A.14.7 Box Culvert Photo 2

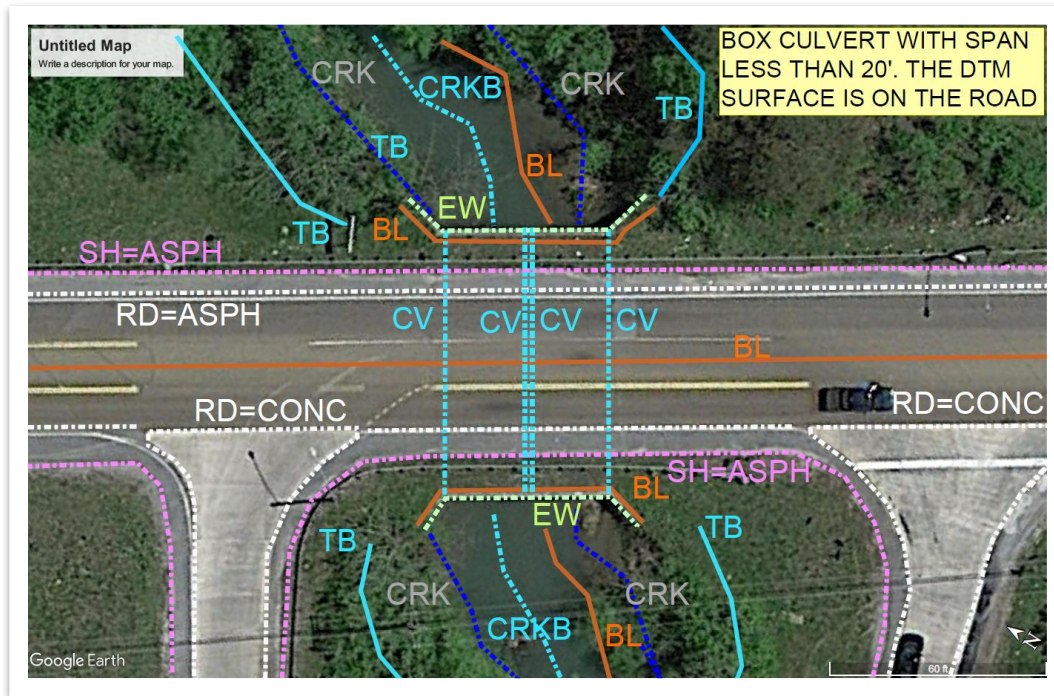

A.14.8 Creek Photo 1

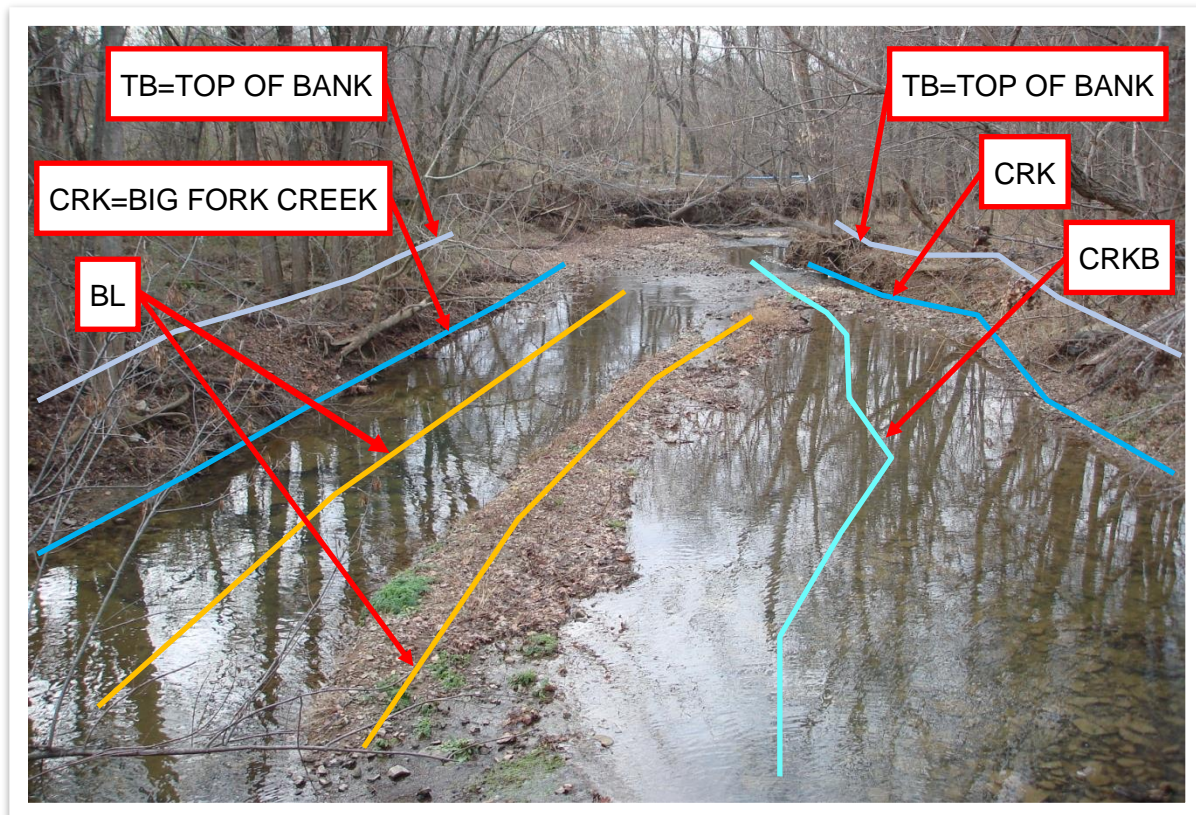

A.14.9 Bridge Photo 1

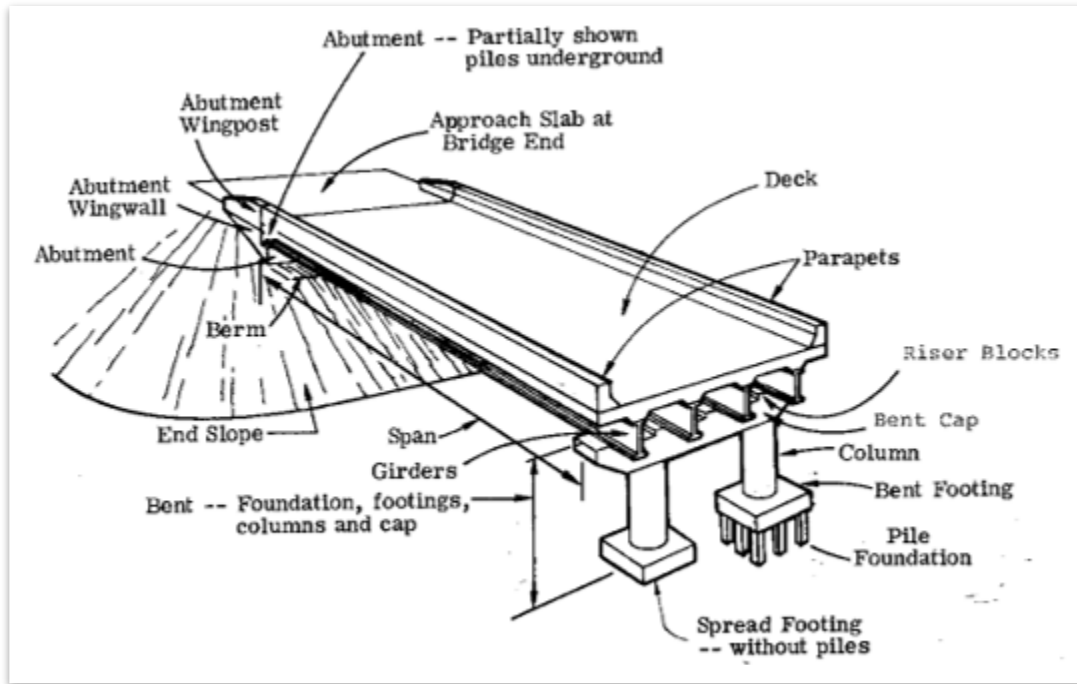

A.14.10 Bridge Photo 2

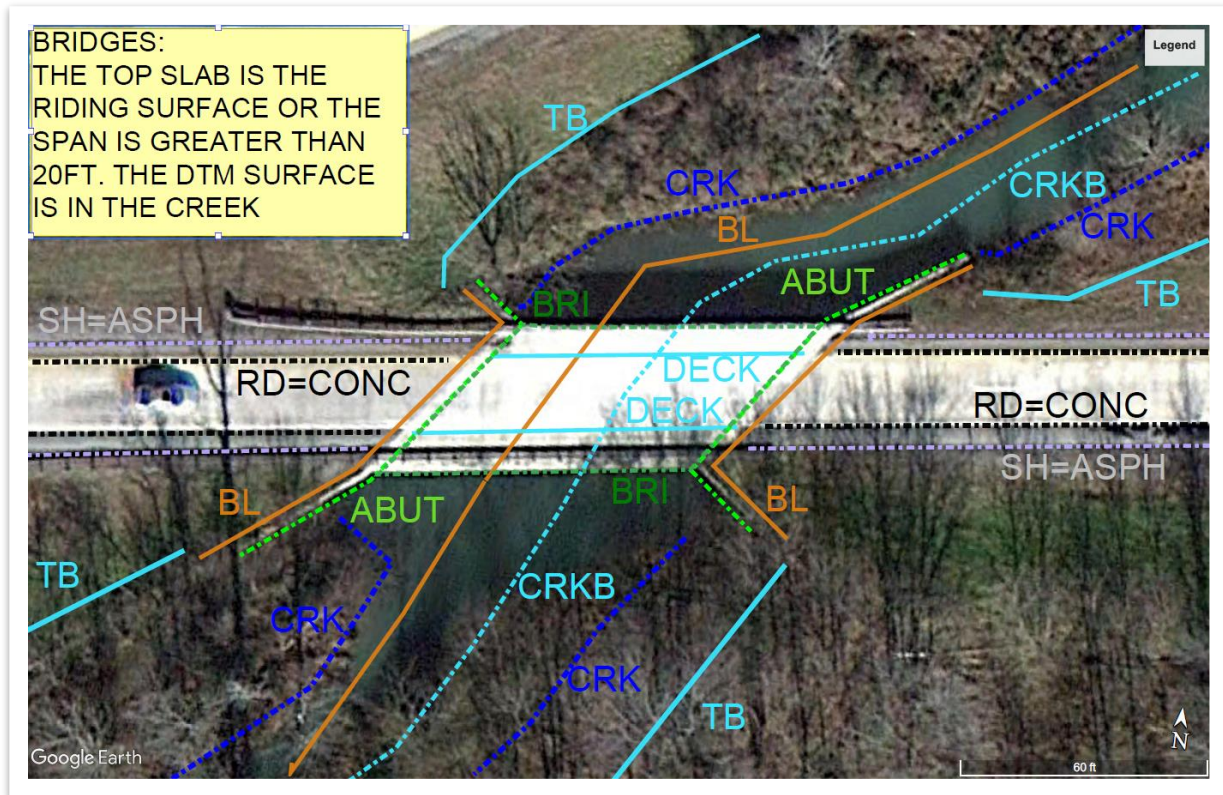

A.14.11 Bridge Photo 3

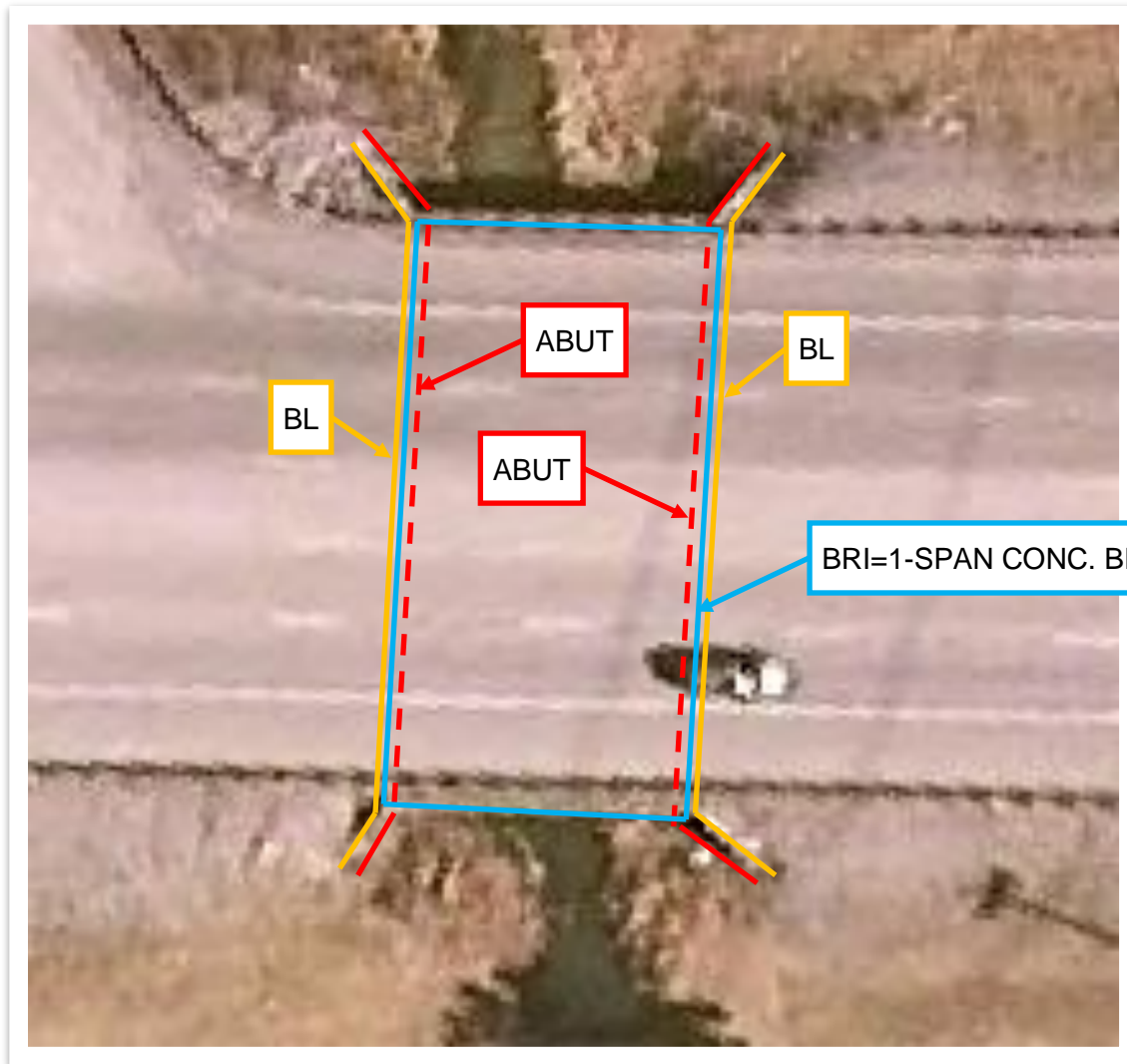

A.14.12 Bridge Photo 4

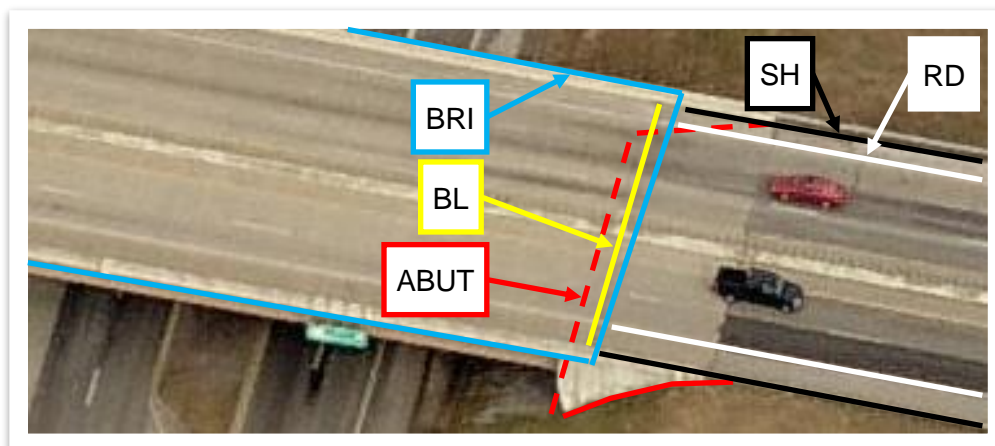

A.14.13 Utility Photo 1

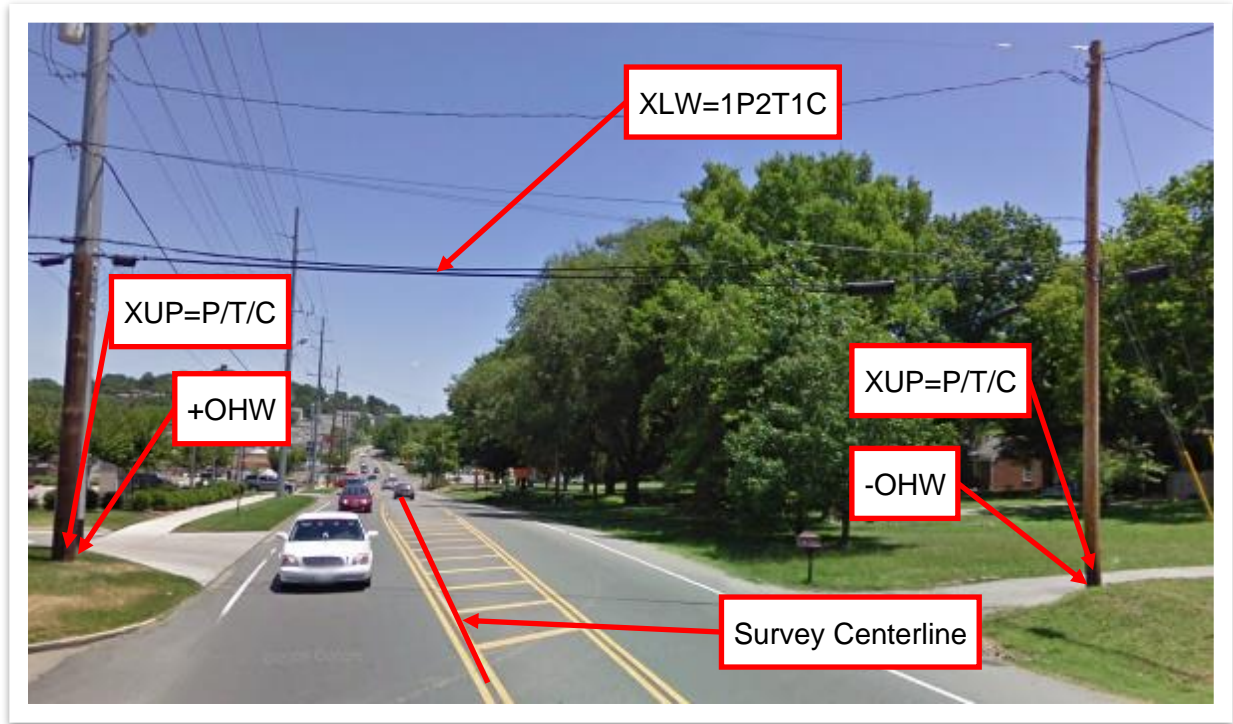

A.14.14 Utility Photo 2

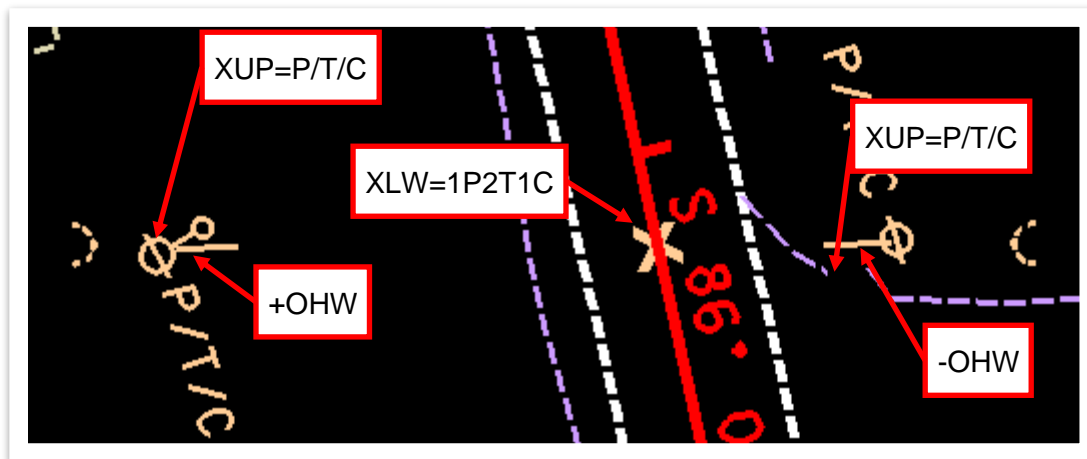

Appendix B. TDOT Occupational Health & Safety Div: Instructional & Info Memo

TO: All Project Development Employees during performance of Surveying Activities

FROM: Lee Bogle, PE
State Safety Engineer, Occupational Health & Safety Division

DATE: October 10, 2018

SUBJECT: **Improved Safety Awareness during performance of Surveying Activities**

Members of Project Development Staff have recently requested guidance and information regarding traffic control, specifically, Temporary Traffic Control procedures for their personnel while conducting survey activities. In most cases, these activities are conducted in a manner and during timeframes that are addressed in the *Manual on Uniform Traffic Control Devices* (MUTCD). This document is intended to provide instructional guidance and address common activities and how they should be conducted following the guidance and requirements outlined in the MUTCD.

It is encouraged that Project Development Supervisors discuss this information with direct reports engaged in survey activities. This document does not encompass all potential hazards associated with survey activities. However, it should be used as a discussion tool to highlight and identify potential hazards associated with these activities. Questions or requests for additional information may be directed to the Regional Safety Managers.

Application

This instructional and informational memorandum on Temporary Traffic Control procedures for **Improved Safety Awareness during performance of Surveying Activities**; applies to all managers, crew leaders, technicians and support personnel engaged in Surveying activities.

Definitions

As outlined in the current edition of the *MUTCD* in *Section 6G.02, Work Duration*, the criteria for duration should be reviewed to identify the type of operation being performed. Among the terms listed, the following will most often apply to typical survey activities:

- **Short-Term stationary**: is daytime work that occupies a location for more than 1 hour within a single daylight period.
- **Short Duration**: is work that occupies a location up to 1 hour

Portable Temporary Traffic Control (TTC) signs and sign stands should be utilized during all TTC activities. Sign sizes are shown in *Table 6F-1* of the *MUTCD*. Generally, a minimum of 36" x 36" sign should be used on State Routes with a speed ≤ 55 MPH and a minimum of 48" x 48" sign should be used on high speed State Routes ≥ 65 MPH and all Interstates.

Personal Protective Equipment (PPE) should be worn in accordance with *TDOT Policy 305-01*.

Guidance for lighting is provided in *TDOT's Warning Light Standardization Manual* with approved lighting packages that will satisfy criteria listed in the *Typical Applications of Chapter 6H* of the *MUTCD*, as sign substitutions. Check the specific *Typical Application* for guidance on appropriate substitutions.

Guidance Information

Survey activities for Project Development personnel are typically conducted on State ROW and Public / Private Properties. Some of the typical activities conducted include:

1. **Data collection/survey away from State owned/maintained facilities.**
 - a. City/County road intersections – Utilize *MUTCD* guidance for TTC needed for the facility, type of work activity and duration
 - b. Public / Private parcels – typically off-roadway system
 - c. Drainage, structural, geotechnical features, survey control points - Utilize *MUTCD* guidance for TTC needed, based on the facility and type of work activity.
2. **Data Collection/survey not impacting traffic flow – *Work Beyond the Shoulder***
 - a. Refer to *MUTCD, Figure 6H-1 – Typical Application 1*
 - i. **Note:** *Option 4; For short-term, short duration or mobile operation, all signs and channelizing devices may be eliminated if a vehicle with activated high-intensity rotating, flashing, oscillating or strobe lights is used.*
3. **Data collection/survey adjacent to travel lanes – *Work on Shoulders***
 - a. Identify duration of planned activity – *Short Term or Short Duration*, typical
 - i. *Short Term (>1hr):* TTC should be installed to include signs, cones and arrow boards
 - ii. *Short Duration ($\leq 1hr$):* As indicated in *Figure 6H-4, Typical Application 4, Option 4; Stationary warning signs may be omitted for short duration or mobile operations if the work vehicle displays high-intensity rotating, flashing, oscillating or strobe lights.*
 - b. Refer to *MUTCD, Figures 6H-3&4 – Typical Applications 3 & 4*

4. **Data collection/survey in and near active travel lanes including medians, edge and center lines, intersections, ramps, bridges, drainage, geotechnical and all other control points and features, etc.**
 - a. Identify duration of planned activity – *Short Term or Short Duration, typical*
 - i. *Short Term (>1hr)*: TTC should be installed to include signs, cones and arrow boards in accordance with the current SOG for *Work Zone Temporary Traffic Control Flagging and Mobile Operations*
 - ii. *Short Duration (≤1hr)*: As indicated in *Figure 6H-10, Typical Application 10*
 - b. Coordination and communication with Operations may be required to effectively manage TTC for these activities.
5. ***Special Case – conducting Survey Activities on, near or adjacent to high speed (≥65MPH) State Routes and all Interstates.**
 - a. Use of an attenuator with arrow or message board is required during all activities utilizing Temporary Traffic Control on high speed State Routes and all Interstates.

Tables and Figures:

Table 6E-1. Stopping Sight Distance as a Function of Speed

Speed*	Distance
20 mph	115 feet
25 mph	155 feet
30 mph	200 feet
35 mph	250 feet
40 mph	305 feet
45 mph	360 feet
50 mph	425 feet
55 mph	495 feet
60 mph	570 feet
65 mph	645 feet
70 mph	730 feet
75 mph	820 feet

* Posted speed, off-peak 85th-percentile speed prior to work starting, or the anticipated operating speed

Table 6H-3. Meaning of Letter Codes on Typical Application Diagrams

Road Type	Distance Between Signs**		
	A	B	C
Urban (low speed)*	100 feet	100 feet	100 feet
Urban (high speed)*	350 feet	350 feet	350 feet
Rural	500 feet	500 feet	500 feet
Expressway / Freeway	1,000 feet	1,500 feet	2,640 feet

* Speed category to be determined by highway agency

** The column headings A, B, and C are the dimensions shown in Figures 6H-1 through 6H-46. The A dimension is the distance from the transition or point of restriction to the first sign. The B dimension is the distance between the first and second signs. The C dimension is the distance between the second and third signs. (The "first sign" is the sign in a three-sign series that is closest to the TTC zone. The "third sign" is the sign that is furthest upstream from the TTC zone.)

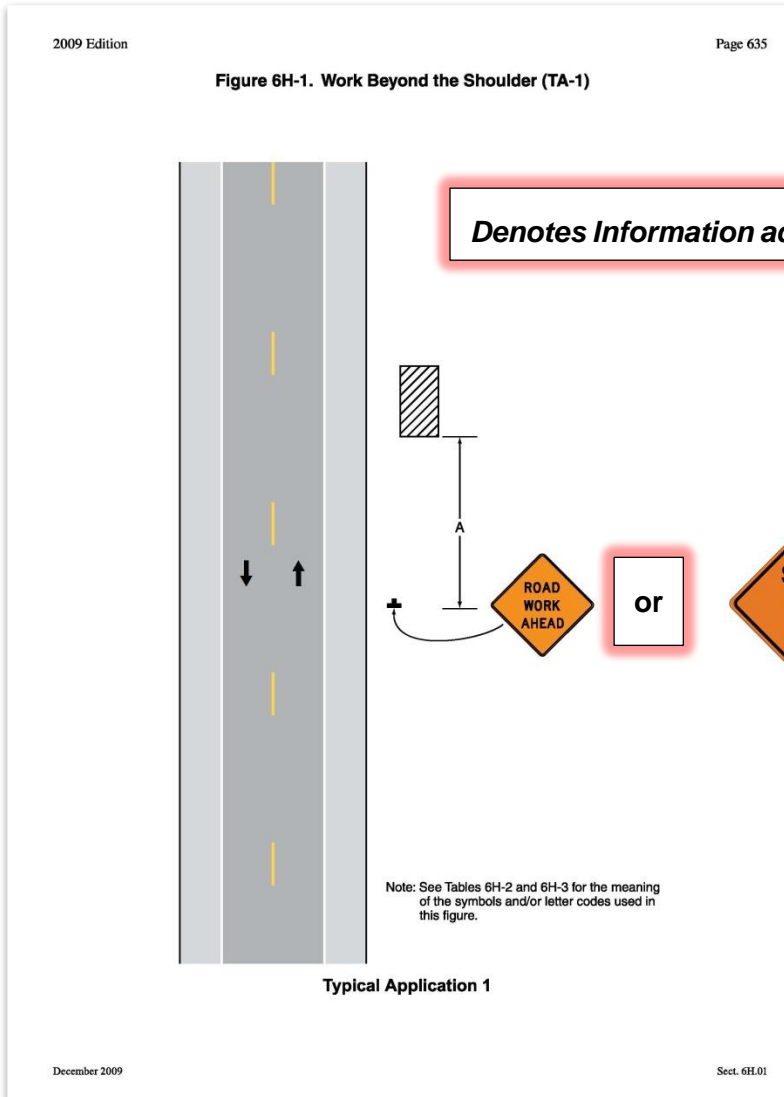

Page 634 2009 Edition

**Notes for Figure 6H-1—Typical Application 1
Work Beyond the Shoulder**

Guidance:

1. If the work space is in the median of a divided highway, an advance warning sign should also be placed on the left side of the directional roadway.

Option:

2. The ROAD WORK AHEAD sign may be replaced with other appropriate signs such as the SHOULDER WORK sign. The SHOULDER WORK sign may be used for work adjacent to the shoulder.
3. The ROAD WORK AHEAD sign may be omitted where the work space is behind a barrier, more than 24 inches behind the curb, or 15 feet or more from the edge of any roadway.
4. For short-term, short duration or mobile operation, all signs and channelizing devices may be eliminated if a vehicle with activated high-intensity rotating, flashing, oscillating, or strobe lights is used.
5. Vehicle hazard warning signals may be used to supplement high-intensity rotating, flashing, oscillating, or strobe lights.

Standard:

6. Vehicle hazard warning signals shall not be used instead of the vehicle's high-intensity rotating, flashing, oscillating, or strobe lights.

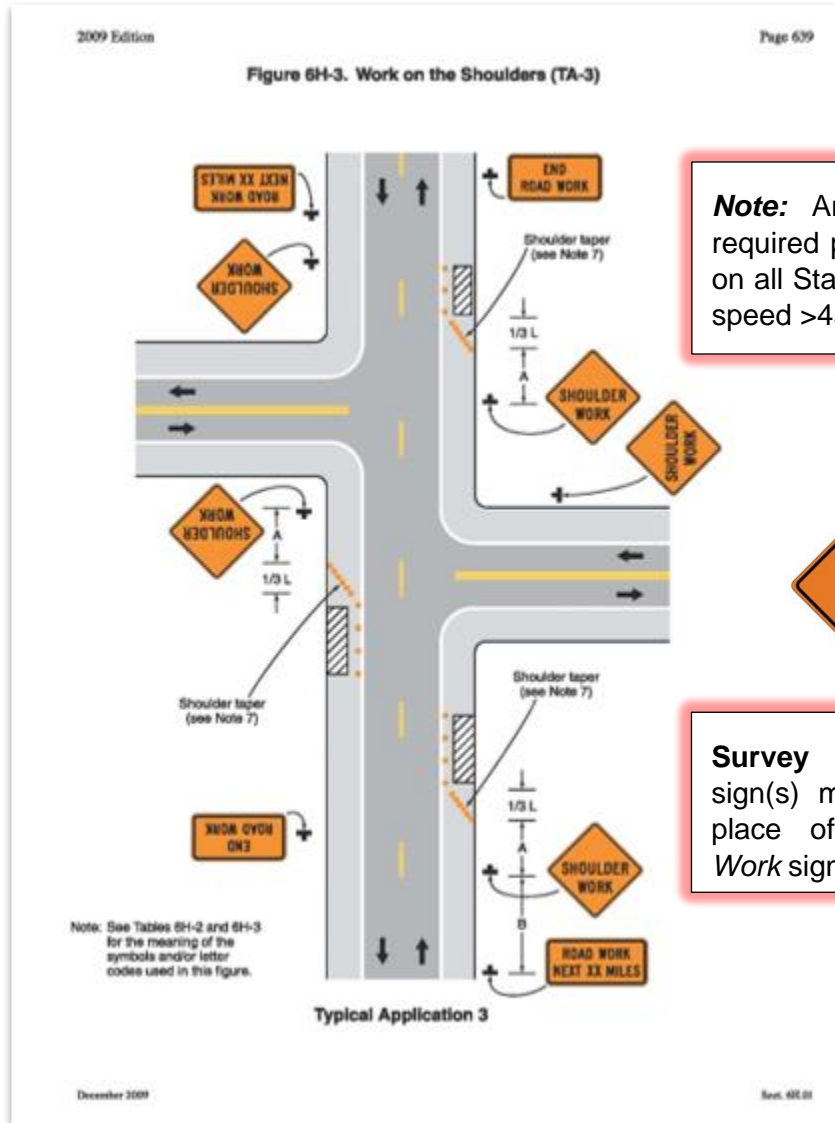

Note: An attenuator is required per SOG 477-01 on all State Routes with a speed >45 MPH.

Survey Crew Ahead sign(s) may be used in place of the *Shoulder Work* sign(s).

Page 638 2009 Edition

**Notes for Figure 6H-3—Typical Application 3
Work on the Shoulders**

Guidance:

1. A **SHOULDER WORK** sign should be placed on the left side of the roadway for a divided or one-way street only if the left shoulder is affected.

Option:

2. The Workers symbol signs may be used instead of SHOULDER WORK signs.
3. The SHOULDER WORK AHEAD sign on an intersecting roadway may be omitted where drivers emerging from that roadway will encounter another advance warning sign prior to this activity area.
4. For short duration operations of 60 minutes or less, all signs and channelizing devices may be eliminated if a vehicle with activated high-intensity rotating, flashing, oscillating, or strobe lights is used.
5. Vehicle hazard warning signals may be used to supplement high-intensity rotating, flashing, oscillating, or strobe lights.

Standard:

6. Vehicle hazard warning signals shall not be used instead of the vehicle's high-intensity rotating, flashing, oscillating, or strobe lights.
7. When paved shoulders having a width of 8 feet or more are closed, at least one advance warning sign shall be used. In addition, channelizing devices shall be used to close the shoulder in advance to delineate the beginning of the work space and direct vehicular traffic to remain within the traveled way.

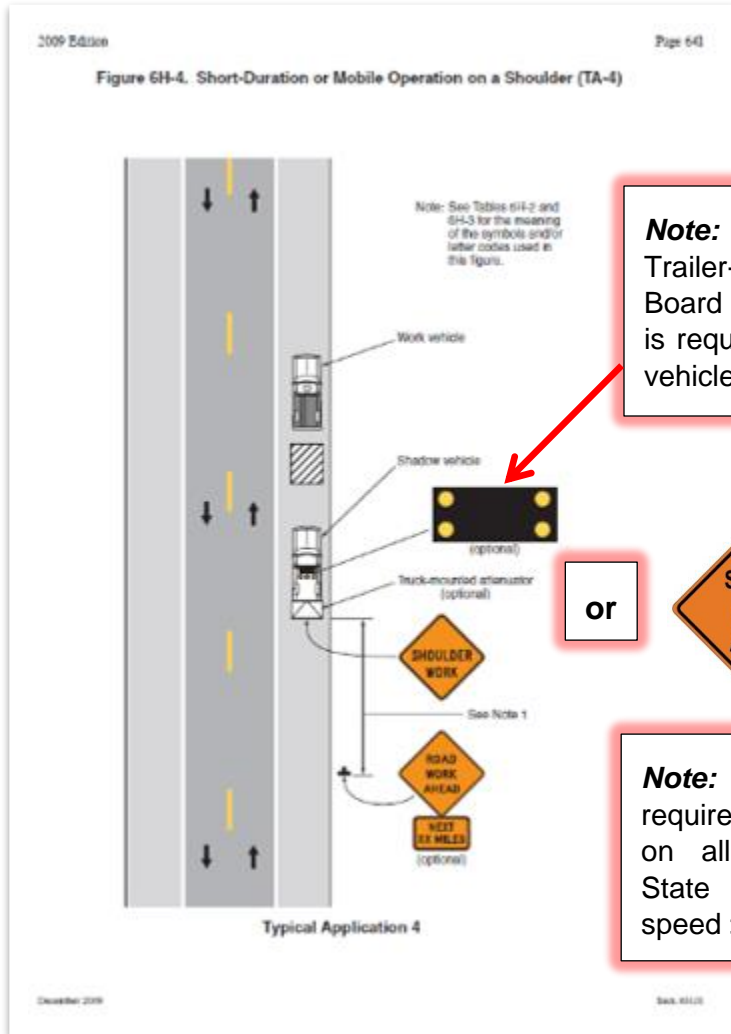

Note: Use of a Truck or Trailer-Mounted Arrow Board or Message Board is required with the work vehicle.

or



Note: An attenuator is required per SOG 477-01 on all Interstates and State Routes with a speed >45 MPH.

Page 640 2009 Edition

Notes for Figure 6H-4—Typical Application 4
Short Duration or Mobile Operation on a Shoulder

Guidance:

1. In those situations where multiple work locations within a limited distance make it practical to place stationary signs, the distance between the advance warning sign and the work should not exceed 5 miles.
2. In those situations where the distance between the advance signs and the work is 2 miles to 5 miles, a Supplemental Distance plaque should be used with the ROAD WORK AHEAD sign.

Option:

3. The ROAD WORK NEXT XX MILES sign may be used instead of the ROAD WORK AHEAD sign if the work locations occur over a distance of more than 2 miles.
4. Stationary warning signs may be omitted for short duration or mobile operations if the work vehicle displays high-intensity rotating, flashing, oscillating, or strobe lights.
5. Vehicle hazard warning signals may be used to supplement high-intensity rotating, flashing, oscillating, or strobe lights.

Standard:

6. Vehicle hazard warning signals shall not be used instead of the vehicle's high-intensity rotating, flashing, oscillating, or strobe lights.
7. If an arrow board is used for an operation on the shoulder, the caution mode shall be used.
8. Vehicle-mounted signs shall be mounted in a manner such that they are not obscured by equipment or supplies. Sign legends on vehicle-mounted signs shall be covered or turned from view when work is not in progress.

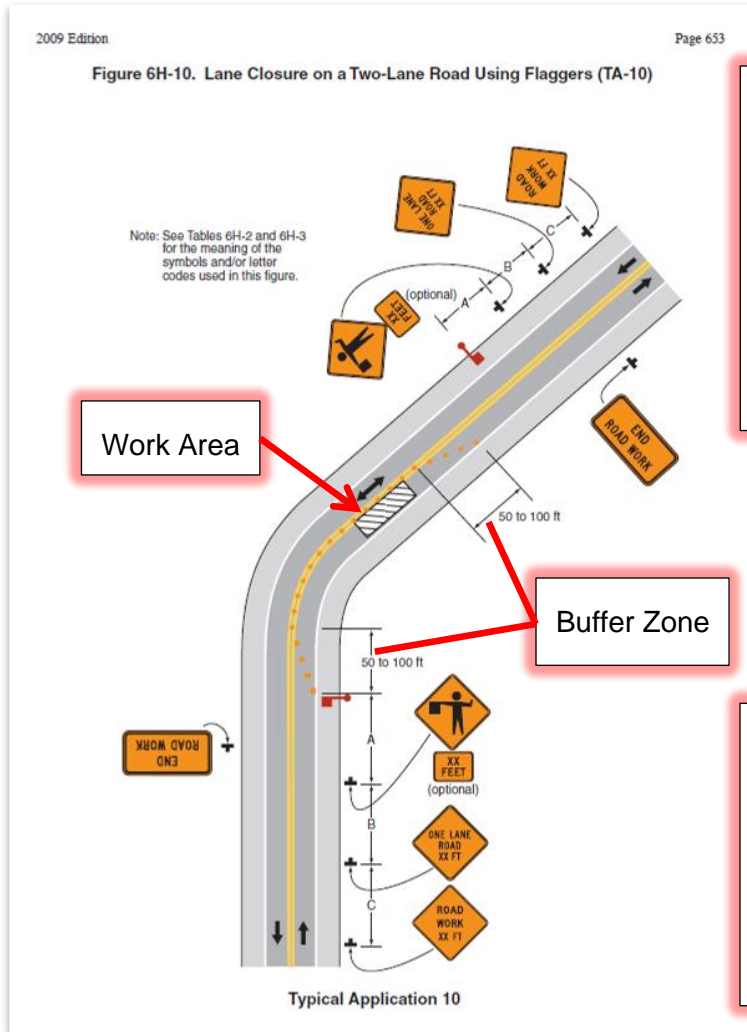

NOTE: Due to the amount and types of devices needed for Temporary Traffic Control, this level of survey work should be conducted with coordination and assistance from Operations to provide equipment and personnel managing the Work Zone and devices.

*An Attenuator should be stationed between the Buffer Zone and Work Area with an appropriate Roll-Ahead Distance provided. Guidance provided in the current SOG 477-01 for WZ TTC Flagging and Mobile Operations.

- Page 652 2009 Edition
- Notes for Figure 6H-10—Typical Application 10**
Lane Closure on a Two-Lane Road Using Flaggers
- Option:
- For low-volume situations with short work zones on straight roadways where the flagger is visible to road users approaching from both directions, a single flagger, positioned to be visible to road users approaching from both directions, may be used (see Chapter 6E).
 - The ROAD WORK AHEAD and the END ROAD WORK signs may be omitted for short-duration operations.
 - Flashing warning lights and/or flags may be used to call attention to the advance warning signs. A BE PREPARED TO STOP sign may be added to the sign series.
- Guidance:
- The buffer space should be extended so that the two-way traffic taper is placed before a horizontal (or crest vertical) curve to provide adequate sight distance for the flagger and a queue of stopped vehicles.
- Standard:
- At night, flagger stations shall be illuminated, except in emergencies.
- Guidance:
- When used, the BE PREPARED TO STOP sign should be located between the Flagger sign and the ONE LANE ROAD sign.
 - When a grade crossing exists within or upstream of the transition area and it is anticipated that queues resulting from the lane closure might extend through the grade crossing, the TTC zone should be extended so that the transition area precedes the grade crossing.
 - When a grade crossing equipped with active warning devices exists within the activity area, provisions should be made for keeping flaggers informed as to the activation status of these warning devices.
 - When a grade crossing exists within the activity area, drivers operating on the left-hand side of the normal center line should be provided with comparable warning devices as for drivers operating on the right-hand side of the normal center line.
 - Early coordination with the railroad company or light rail transit agency should occur before work starts.
- Option:
- A flagger or a uniformed law enforcement officer may be used at the grade crossing to minimize the probability that vehicles are stopped within 15 feet of the grade crossing, measured from both sides of the outside rails.

Appendix C. Figures and Tables

C.1 Property Owner Contact Forms and Letters

C.1.1 Contact Form

The **Property Owner Contact Form** can be found under the **Standard Survey CADD Files and Documents >> Property Owners** heading on this site:

<https://www.tn.gov/tdot/roadway-design/survey-standards/survey-cadd-files.html>

C.1.2 Contact Letters (Aerial, Geotechnical, ROW, Survey)

The **Contact Letters** can be found under the **Standard Survey CADD Files and Documents >> Property Owners** heading on this site:

<https://www.tn.gov/tdot/roadway-design/survey-standards/survey-cadd-files.html>

C.2 R.O.W. Acquisition Tables

The **R.O.W. Acquisition Table** and the **Survey Contact Letter and R.O.W. Acquisition Table Creator** can be found under the **Standard Survey CADD Files and Documents >> Others** heading on this site:

<https://www.tn.gov/tdot/roadway-design/survey-standards/survey-cadd-files.html>

C.3 Tennessee Reservoirs

MAINSTREAM	FULL POOL CONTOUR ft (m)	MAXIMUM SHORELINE CONTOUR ft (m)
Kentucky	359 (109.4)	375 (114.3)
Guntersville	595 (181.4)	600 (182.9)
Nickajack	634 (193.2)	640 (195.1)
Chickamauga	682.5 (208.03)	690 (210.3)
Watts Bar	741 (225.9)	750 (228.6)
Fort Loudon	813 (247.8)	820 (249.9)
TRIBUTARY RESERVOIRS	FULL POOL CONTOUR ft (m)	MAXIMUM SHORELINE CONTOUR ft (m)
Boone	1385 (422.1)	1390 (423.7)
Cherokee	1073 (327.1)	1080 (329.2)
Douglas	1000 (304.8)	1007 (306.9)
Ft. Patrick Henry	1263 (385.0)	1268 (386.5)
Great Falls ¹	805.3 (245.46)	812 (247.5)
Melton Hill	795 (242.3)	800 (243.8)
Nolichucky	1241 (378.3)	1246 (379.8)
Normandy	875 (266.7)	885 (269.7)
Norris	1020 (310.9)	1044 (318.2)
Ocoee No. 1	837.65 (255.317)	842.6 (256.8)
Ocoee No. 3	1435 (437.4)	1440 (438.9)
South Holston	1729 (527.0)	1747 (532.5)
Tellico	813 (247.8)	820 (249.9)
Tims Ford	888 (270.7)	895 (272.8)
Watauga	1959 (597.1)	1980 (603.5)

¹ Outside Tennessee River drainage area. Section 26a does not apply. TVA land or landrights may be involved.

C.4 Present Layout Sheets

C.4.1 Example 1

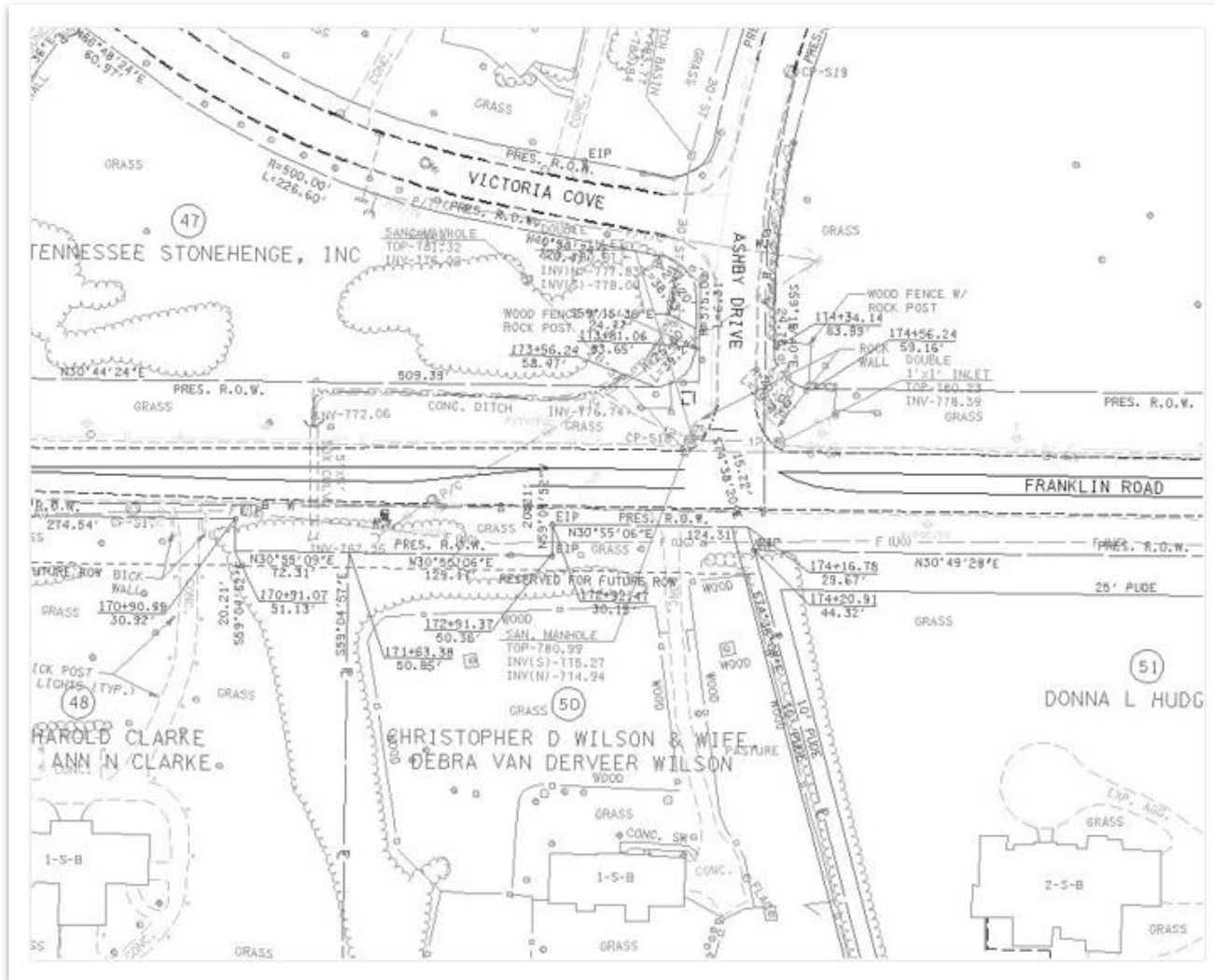

C.4.2 Example 2

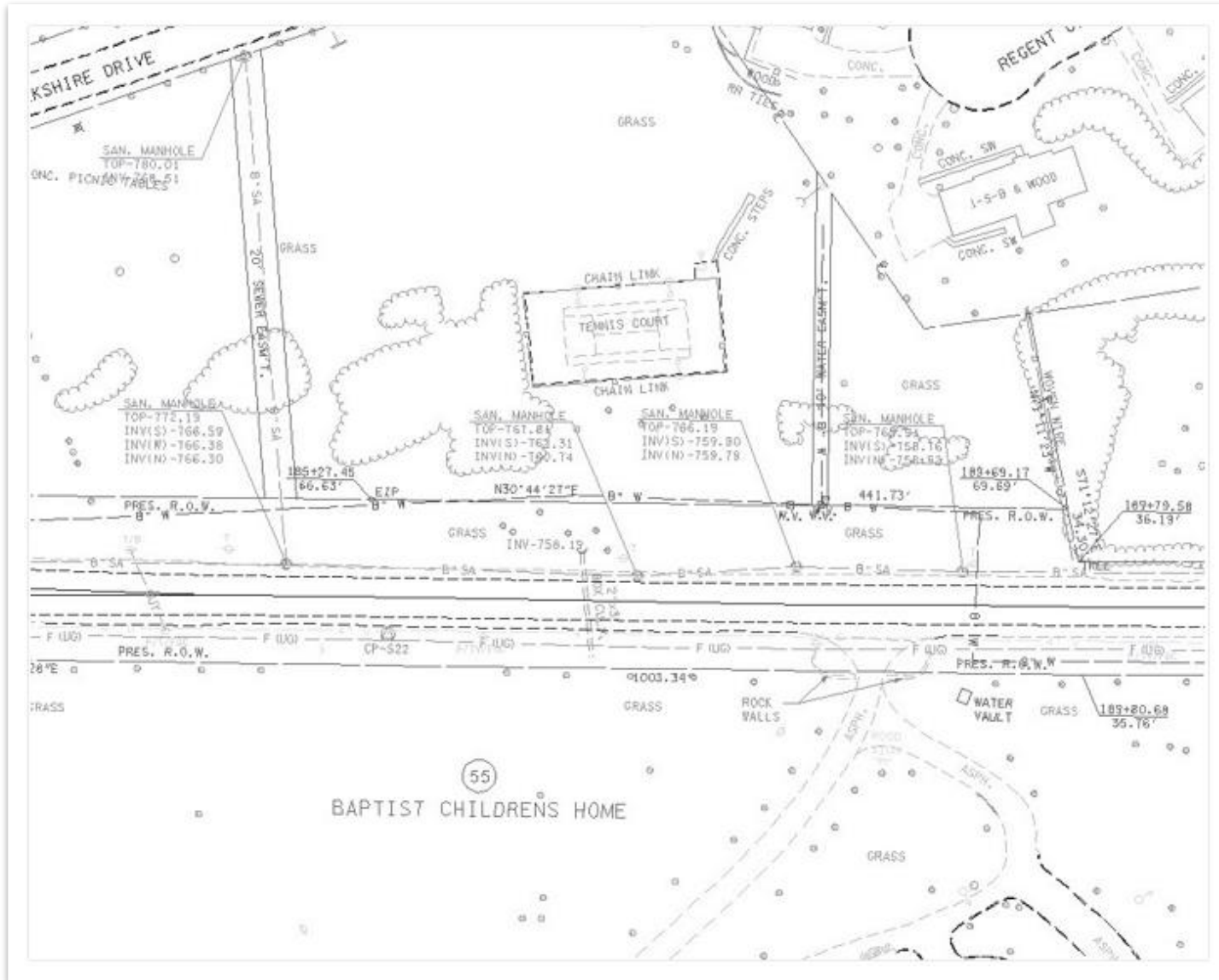

C.4.3 Example 3

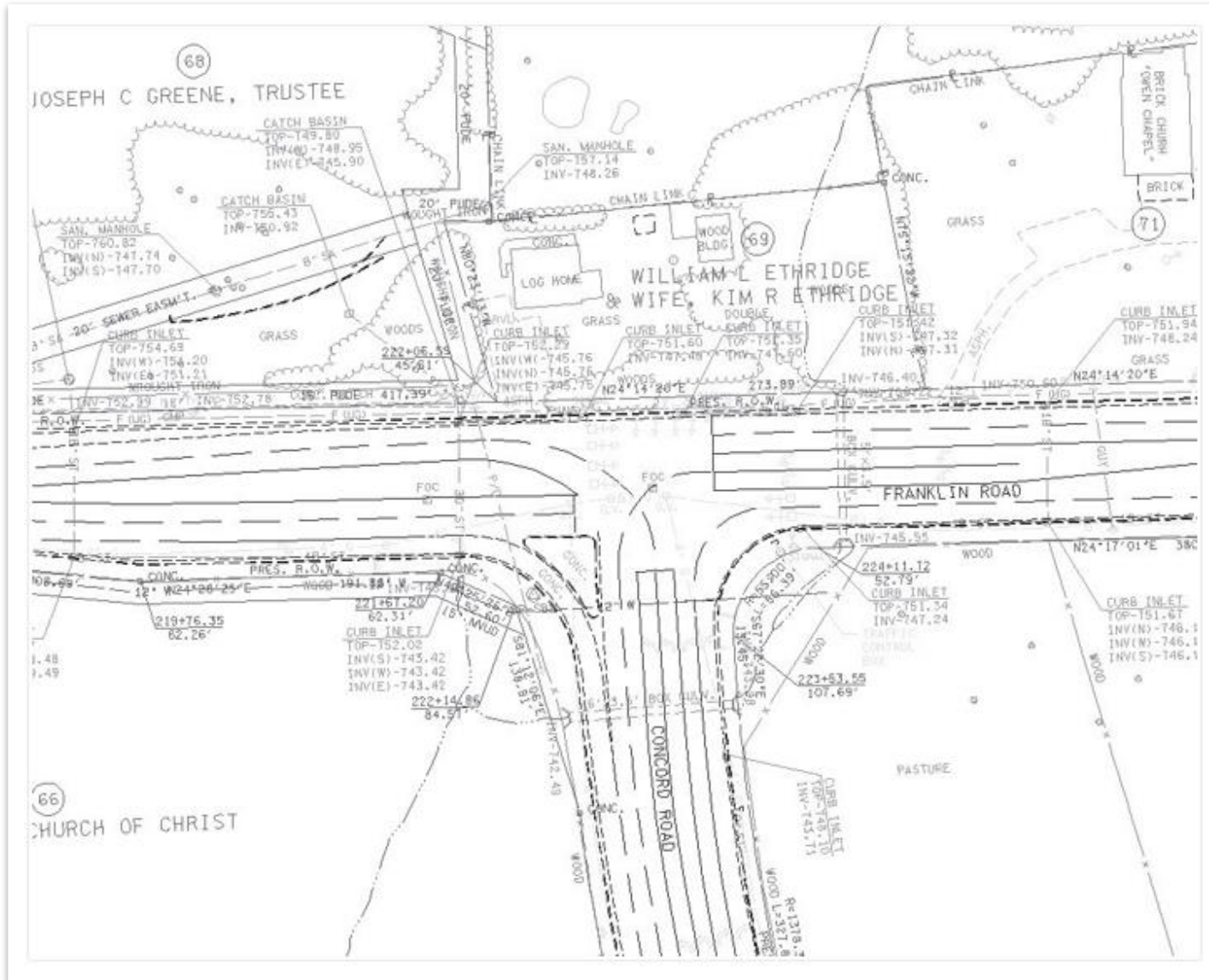

C.5 Profiles

C.5.1 Example 1

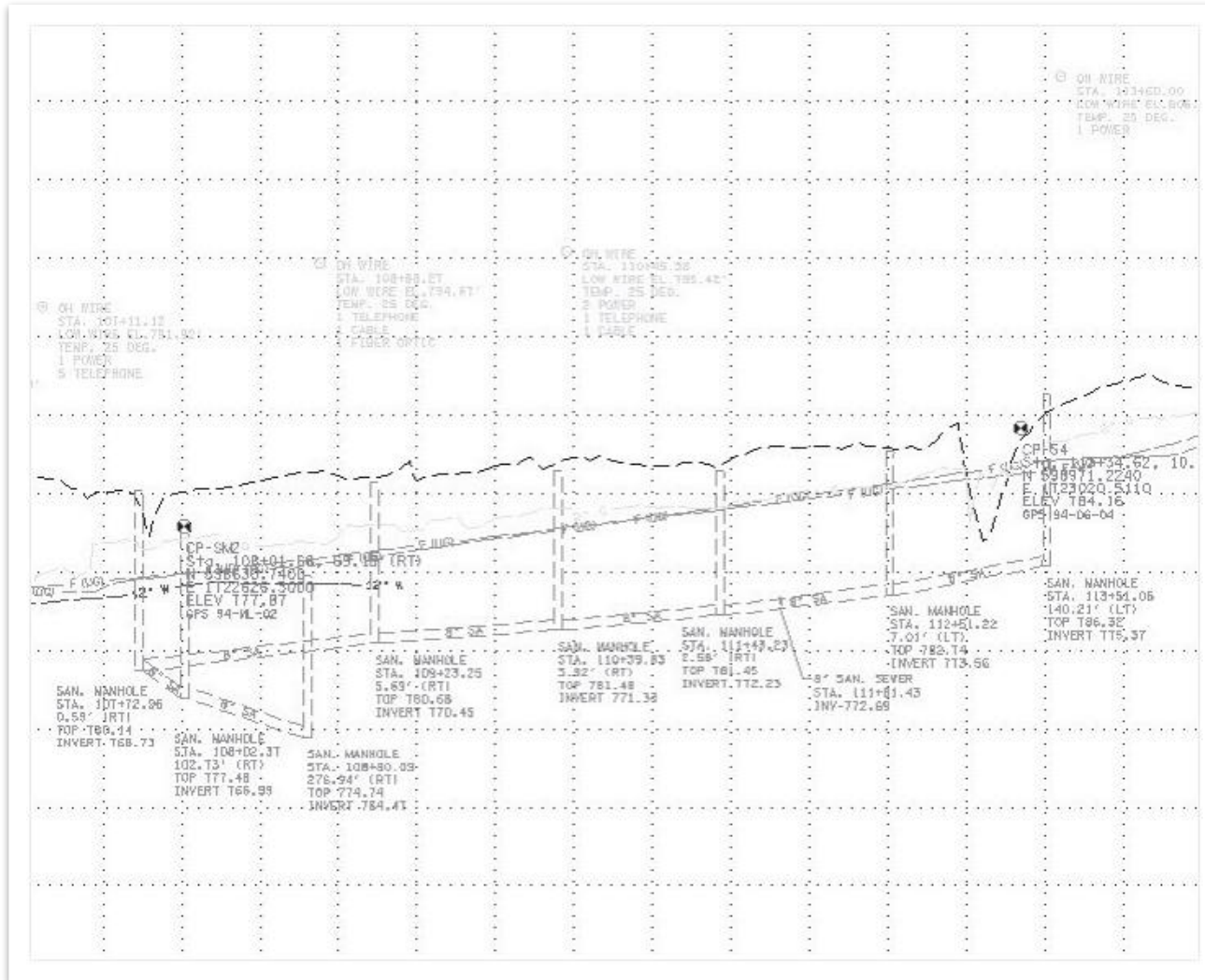

C.5.2 Example 2

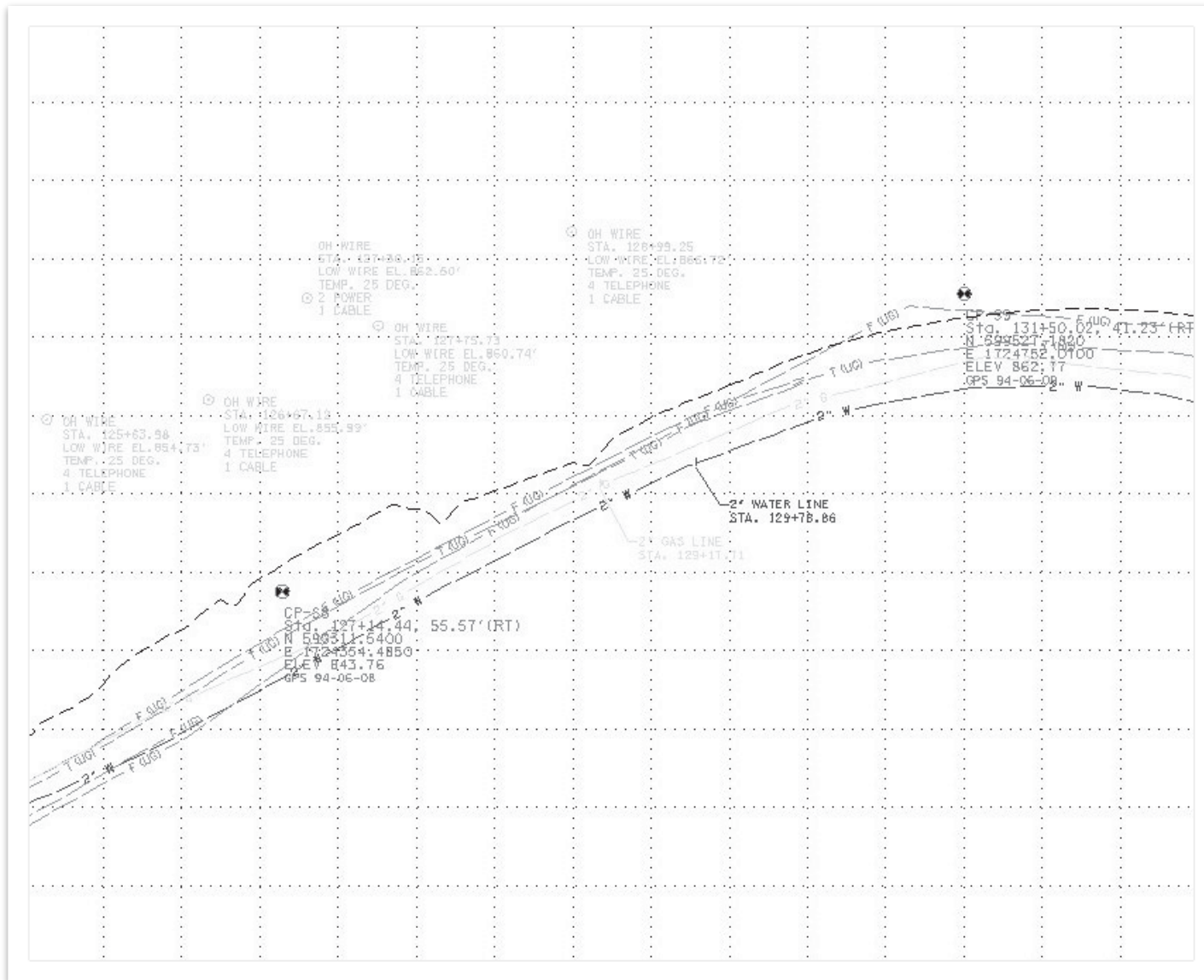

C.5.3 Example 3

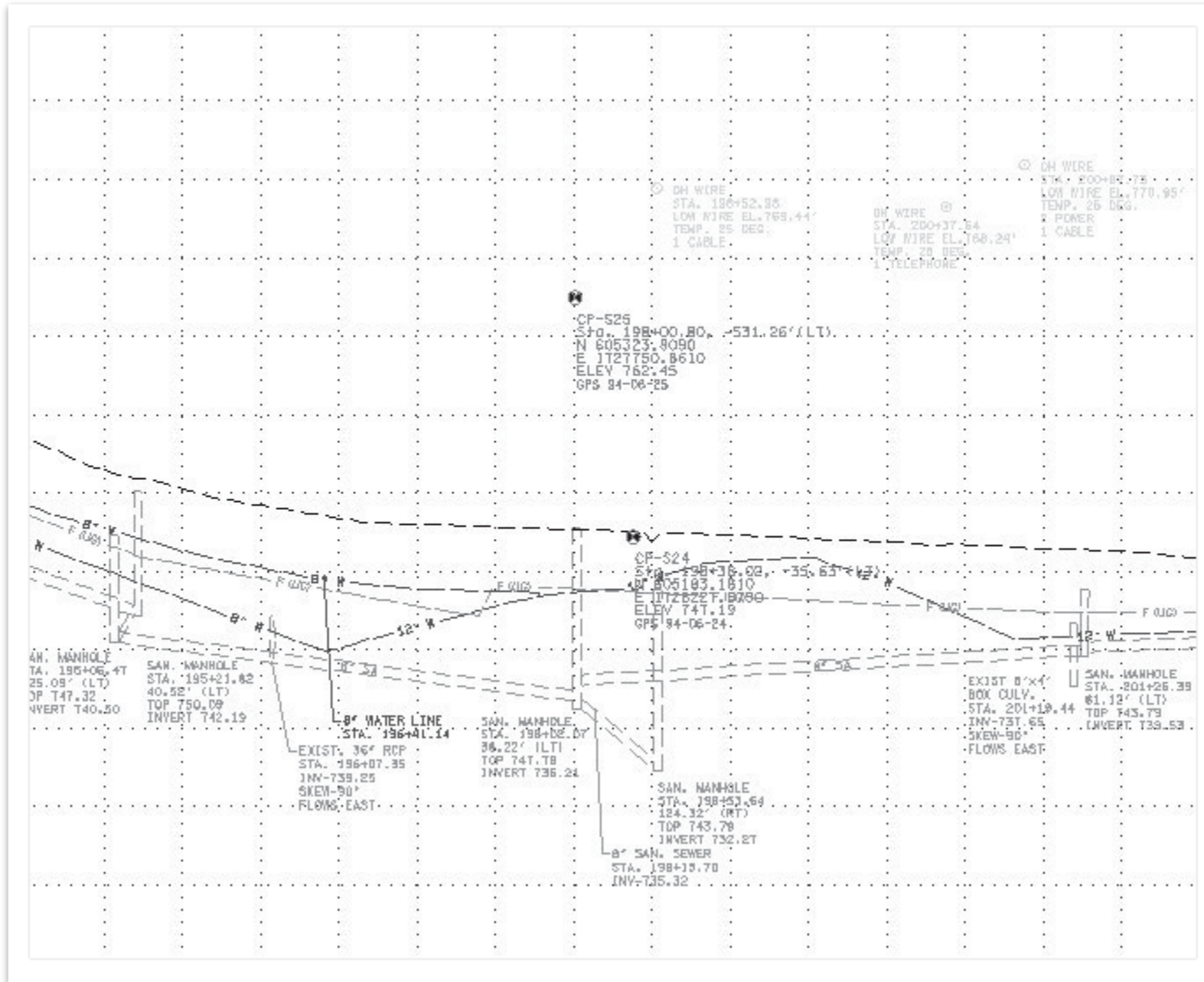

C.6 Drainage Maps

C.6.1 Example 1

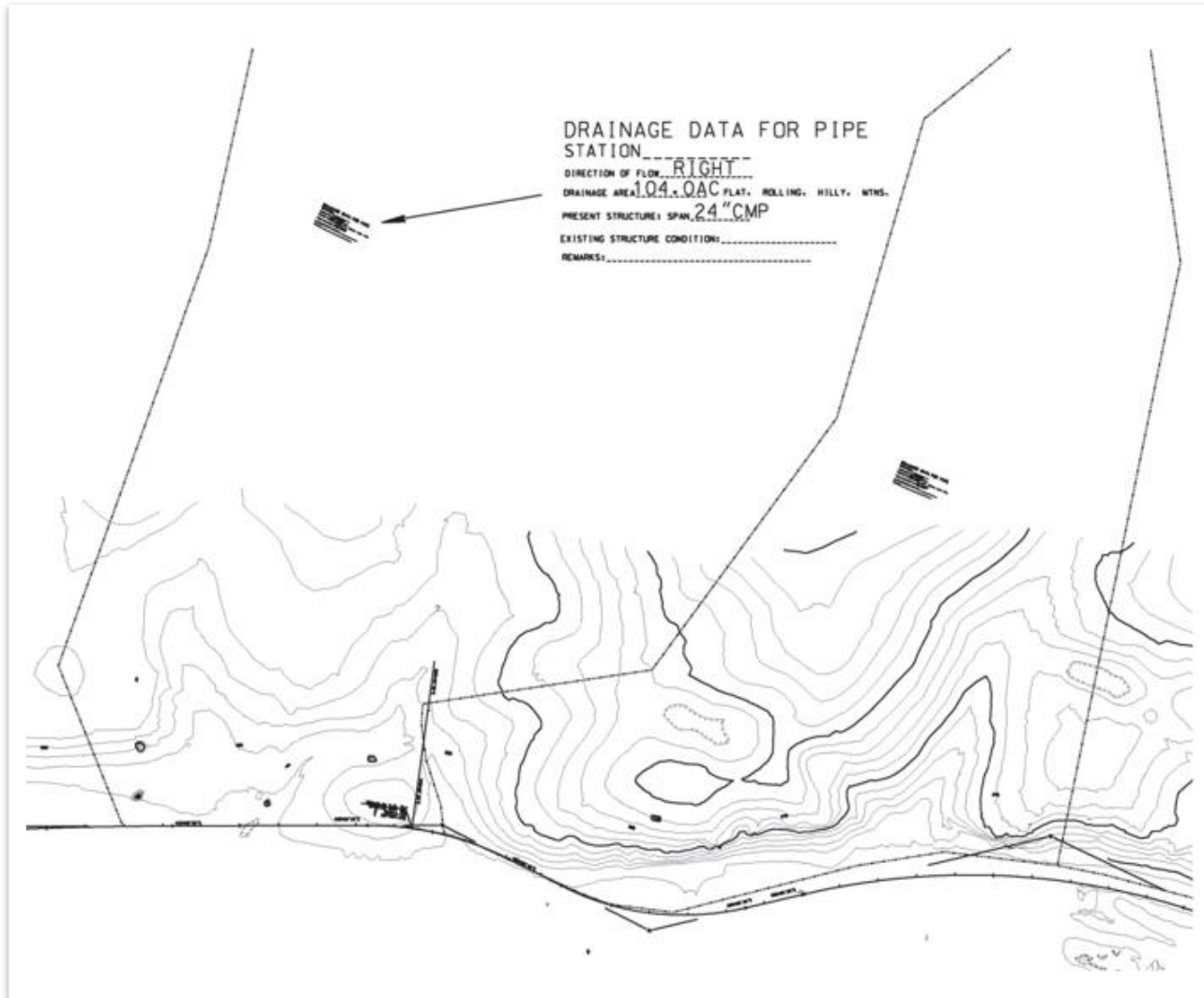

C.7 Survey Standards

C.7.1 Horizontal Example

SURVEY STANDARDS HORIZONTAL					
	FIRST ORDER	SECOND ORDER		THIRD ORDER	
		Class I	Class II	Class I	Class II
POSITION CLOSURE	1:100,000 or $0.17 \text{ ft. } \sqrt{M}$	1:50,000 or $0.33 \text{ ft. } \sqrt{M}$	1:20,000 or $0.83 \text{ ft. } \sqrt{M}$	1:10,000 or $1.66 \text{ ft. } \sqrt{M}$	1:5,000 or $3.33 \text{ ft. } \sqrt{M}$
NUMBER OF COURSES BETWEEN AZIMUTH CHECKS	5-6	10-12	15-20	20-25	30-40
AZIMUTH CLOSURE AT AZIMUTH CHECKPOINT NOT TO EXCEED	1.0" per traverse point or $2\sqrt{N}$	1.5" per traverse point or $3\sqrt{N}$ Urban 2" per traverse point or $3\sqrt{N}$	2.0" per traverse point or $6\sqrt{N}$ Urban 4" per traverse point or $8\sqrt{N}$	3.0" per traverse point or $10\sqrt{N}$ Urban 6" per traverse point or $15\sqrt{N}$	8.0" per traverse point or $30\sqrt{N}$

N = The number of traverse points for carrying azimuth.
M = Distance in miles
In expressions for closing errors, use the formula that gives the smallest permissible closure.

C.7.2 Vertical Example

SURVEY STANDARDS VERTICAL

	FIRST ORDER		SECOND ORDER		THIRD ORDER
	Class I	Class II	Class I	Class II	
Closure error not to exceed	$0.017 \text{ ft} \cdot \sqrt{M}$	$0.021 \text{ ft} \cdot \sqrt{M}$	$0.025 \text{ ft} \cdot \sqrt{M}$	$0.035 \text{ ft} \cdot \sqrt{M}$	$0.050 \text{ ft} \cdot \sqrt{M}$

M = Distance in miles

C.8 Field Notes

C.8.1 Example 1

STA.	FORWARD		BACK		ELEV.		
	+	-	+	-			
USC & GS BM# 212	4.94				618.41	✓	
TP	3.86	10.22					
TP	2.16	9.76					
TP	4.51	11.31					
TP	5.53	6.83					
TP	4.37	5.42					
BM NO. 1		5.51	5.47		594.70	✓	
			5.41	4.61			
			7.01	4.86			
			10.95	4.63			
			9.82	2.25			
			10.11	3.96			
				4.78			
USC & GS BM# 212	25.34 ✓	49.05 ✓	48.77 ✓	25.09 ✓			
		25.34	25.09				
		$\frac{23.71}{23.68}$ ✓	23.68 ✓				
		0.03 DIFF ✓					
		LINE APPROX. 1.1 MI. ✓					
		12.0v1.1 = 12.6 VS. 1 ✓					
		CHECK ✓					

11-5-09 2

PARIS 1314
ASHTON
BOURNE
PARIS

MON & DISC IN S.W. CORNER OF SR. 22 & JONES ROAD ELEV.
OBTAINED FROM TN DOT AERIAL SURVEY DIV NASHVILLE, TN

ALUMINUM DISH 75" RT. STA. D-45

MON. & DISC. IN S.W. CORNER OF S. 22 & JONES ROAD

REDUCED BY R.A.J.
CHECKED BY S.M.B.

SETTING FIRST BENCH

C.8.4 Example 4

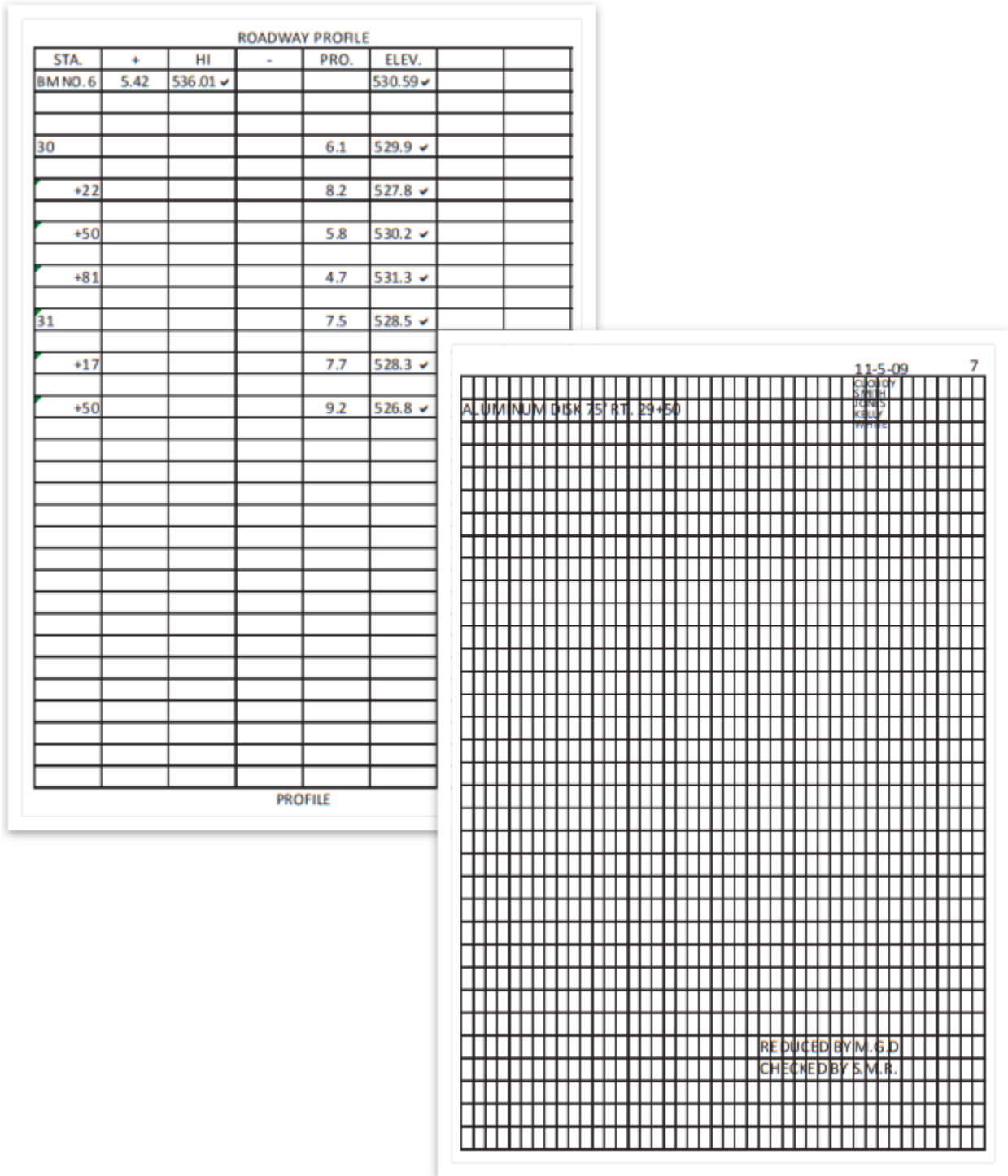

C.9 Aerial Survey Target, Block Imagery and Strip Imagery

C.9.1 Example 1

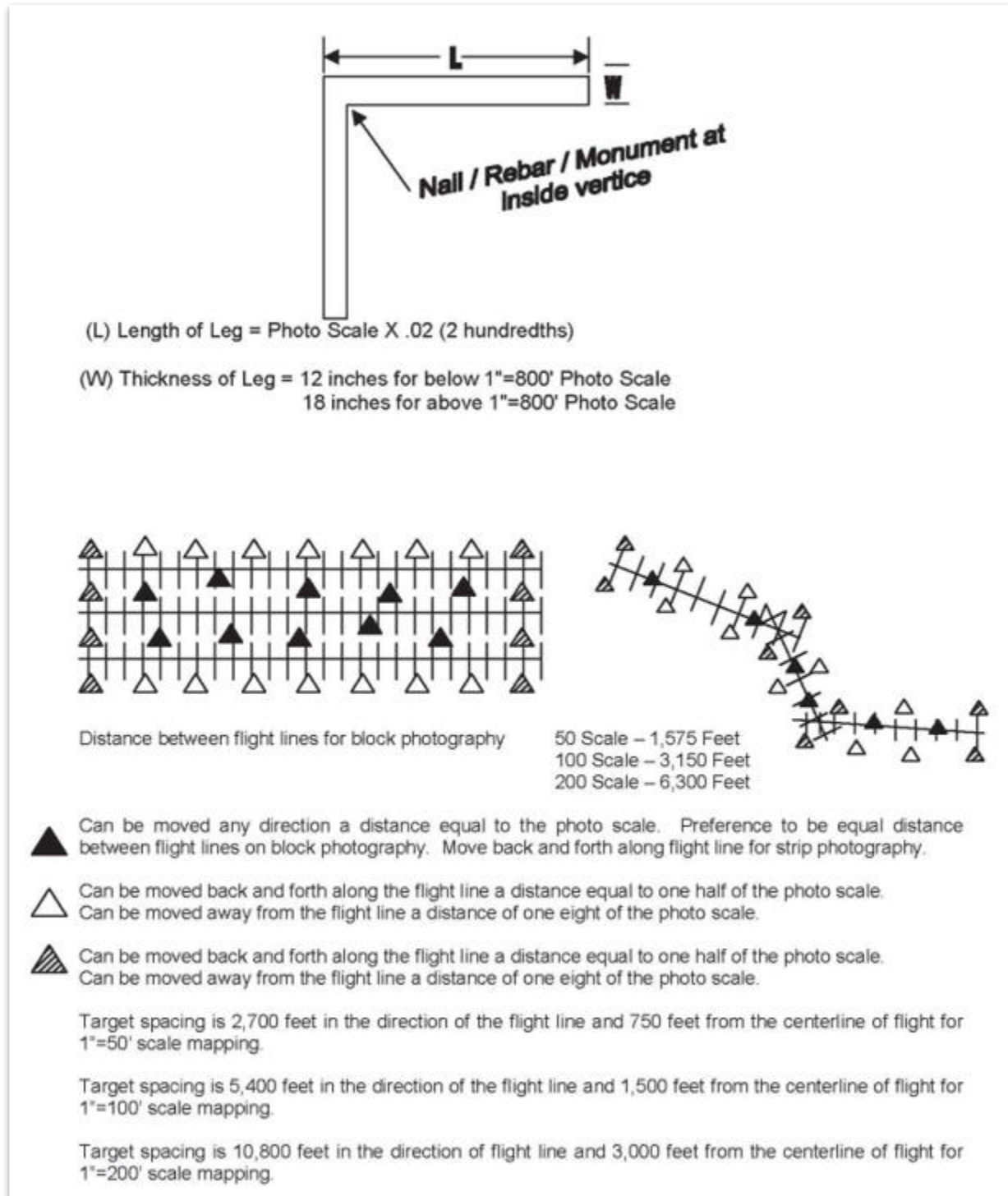

C.10 Preliminary Bridge Drawing (Table)

C.10.1 Example 1

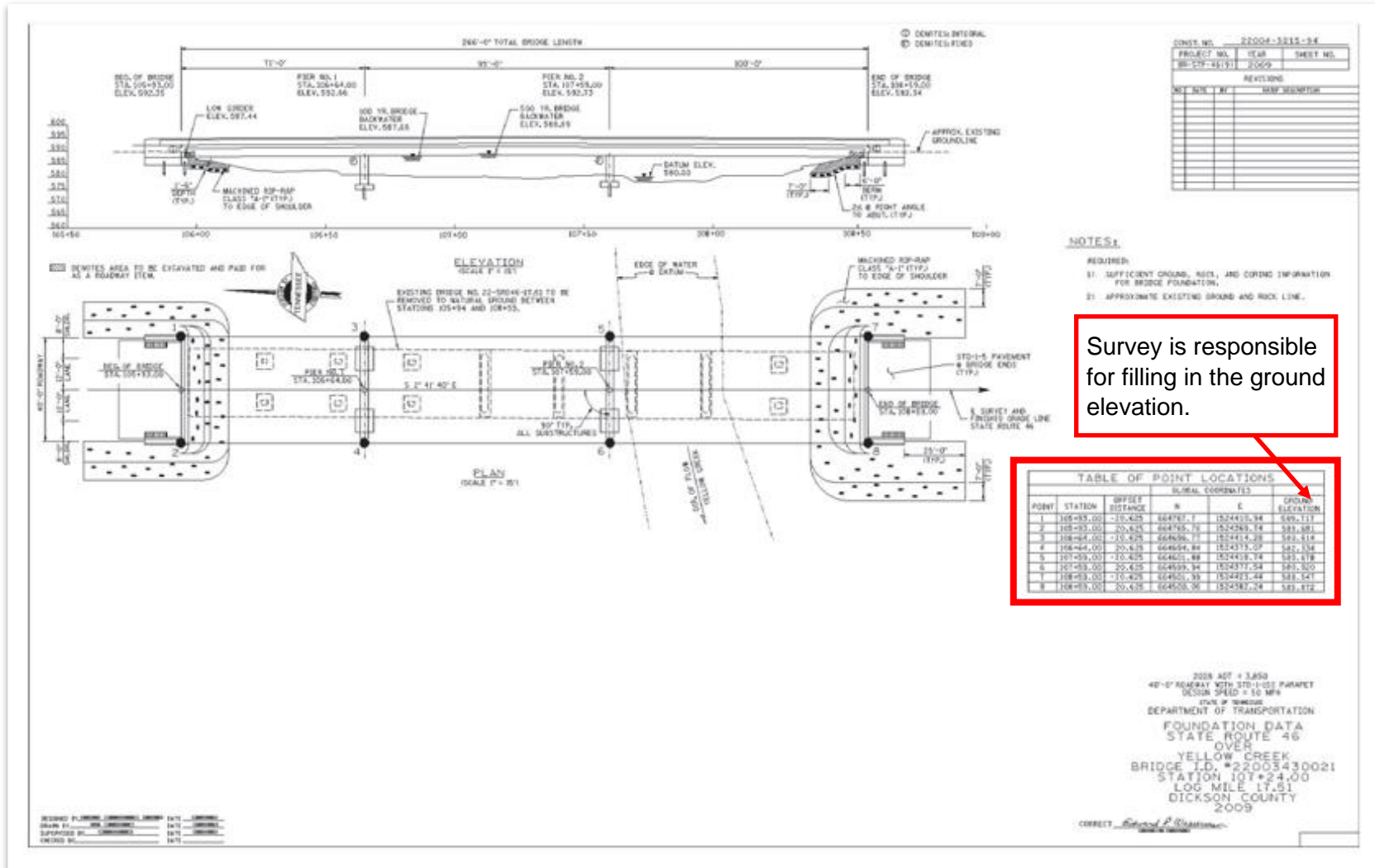

Survey is responsible for filling in the ground elevation.

TABLE OF POINT LOCATIONS

POINT	STATION	OFFSET DISTANCE	GLOBAL COORDINATES		GROUND ELEVATION
			N	E	
1	106+93.00	-10.425	664782.7	1524415.34	589.111
2	106+95.00	-20.615	664785.72	1524269.34	589.881
3	108+44.00	-10.625	664896.77	1524414.28	589.518
4	108+44.00	20.615	664899.89	1524375.07	589.108
5	107+93.00	-10.425	664802.88	1524419.34	589.118
6	107+93.00	20.625	664809.94	1524377.24	589.000
7	108+93.00	-10.425	664902.95	1524423.44	589.541
8	108+93.00	20.625	664905.96	1524387.24	589.472

C.11 NOAA Manual NOS NGS 5

The overall document can be accessed here:

https://www.ngs.noaa.gov/PUBS_LIB/ManualNOSNGS5.pdf

C.11.1 Excerpt 1

EXCERPT FROM NOAA MANUAL NOS NGS 5

This discussion is taken from NOAA Manual NOS NGS 5, "State Plane Coordinate System of 1983". References to the transverse Mercator and oblique Mercator projections have been omitted. Any cross references printed in this section refer only to Sections and Tables from NOAA Manual NOS NGS 5, not to other sections in the Survey Manual.

3. CONVERSION METHODOLOGY

This chapter addresses both "manual" and "automated" methods for performing "conversions" on any Lambert conformal conic projections. Included is conversion from NAD 83 latitude/longitude to SPCS 83 northing/easting, plus the reverse process. For these processes this manual uses the term "conversion," leaving the term "transformation" for the process of computing coordinate values between datums, for example, transforming from NAD 27 to NAD 83 or transforming from SPCS 27 to SPCS 83. In addition to converting point coordinates, methods for conversion of distances, azimuth, and angles are also given.

The "automated" methods for conversions given in Section 3.1 are equations that have been sequenced and structured to facilitate programming. "Manual" methods are generally a combination of simple equations, tables, and intermediate numerical input, requiring only a calculator capable of basic arithmetic operations. Section 3.4 provides such a manual method for the Lambert projection where the intermediate numerical input is polynomial coefficients. Table 3.0 summarizes the conversion computational methods that were used for SPCS 27 and the methods discussed in this manual for SPCS 83.

TABLE 3.0 Summary of Conversion Methods

Datum	Mode	Projection	Method
SPCS 27	Manual	Lambert Transverse Mercator	and Projection tables
		Oblique Mercator	Intersection tables
SPCS 27	Automated	Lambert, Mercator, Oblique Mercator	transverse and Equations and constants described in C&GS Publication (Claire 1968) 62-4
		SPCS 83	Manual
SPCS 83	Manual	Tranverse Mercator	New projection tables (future)
		Oblique Mercator	Automated only
SPCS 83	Automated	Lambert	Polynomial coefficients or new mapping equations (Sec. 3.1)
		Tranverse Mercator	New mapping equations (Sec. 3.2)
		Oblique Mercator	New mapping equations (Sec. 3.3)

C.11.2 Excerpt 2

The mapping equations given in Section 3.1 are not really "new" and may differ little from equations found in geodetic literature. However, they are new in the sense that they are not in the same form as the equations published or programmed by NGS or its predecessors in connection with SPCS 27. Whereas the SPCS 27 equations given in C&GS Publication 62-4 were designed to reproduce exactly the numerical results of an earlier manual method using logarithmic computations and projection tables, the equations here were designed for accuracy and computational efficiency.

Because the mapping equations of the automated approach apply equally to mainframe computers and programmable hand-held calculators, the availability of sufficient significant digits warrants consideration. For the Lambert projection, the method of polynomial coefficients (Sec. 3.4) was developed for machines with only 10 significant digits. With less than 12 digits, the general mapping equations could not guarantee millimeter accuracy in all Lambert zones, particularly in Florida, Louisiana, Texas, South Carolina, Nebraska and Montana. However, the polynomial coefficient method may also prove to be the most efficient for any machine. The general mapping equations will produce submillimeter accuracy when adequate significant digits are available for the computation.

Since the equations are not difficult, the polynomial coefficient method also fills the requirement for a manual method for the Lambert projection.

While it is easy to visualize map projections by considering them a perspective projection of the meridians and parallels of the datum surface onto a surface that develops into a plane, in this age of coordinate plotters a graticule is generally not constructed by these means. Although a set of mechanical procedures can sometimes be defined by which meridians and parallels can be geometrically constructed on the grid using a ruler, compass, and scale, a pair of functions, $N = f_1(\phi, \lambda)$ and $E = f_2(\phi, \lambda)$, always exist. That is, for a point of given latitude (ϕ) and longitude (λ), there exist equations to yield the northing coordinate and equations to yield the easting coordinate when ϕ and λ are substituted into the equations. Likewise, equations must exist to compute the convergence angle, $\gamma = f_3(\phi, \lambda)$, and grid scale factor, $k = f_4(\phi, \lambda)$. These four functions, or equations, comprise the direct conversion process.

Furthermore, it must be possible to perform the inverse computation, requiring another pair of formulas, latitude (ϕ) = $f_5(N, E)$ and longitude (λ) = $f_6(N, E)$. Similarly needed are convergence and grid scale factor as a function of the plane coordinates, $\gamma = f_7(N, E)$ and $k = f_8(N, E)$. Because these are one-to-one mappings, the inverse computation must reproduce the original values.

This chapter provides these eight "mapping equations" for the Lambert conformal conic projection (Sec. 3.1). The definition of the adopted symbols will be given first. Two sets of symbols are listed, the conventional set which incorporates the Greek alphabet and a set available on standard keyboards. The equations in this chapter will use the conventional notation. The entries in the notation section flagged with an asterisk are the constants required to uniquely define one specific zone of that general type of map projection. The values of those zone-defining constants as adopted and legislated by the States are listed in Appendix A.

C.12 Bridge Sketch

C.12.1 Example 1

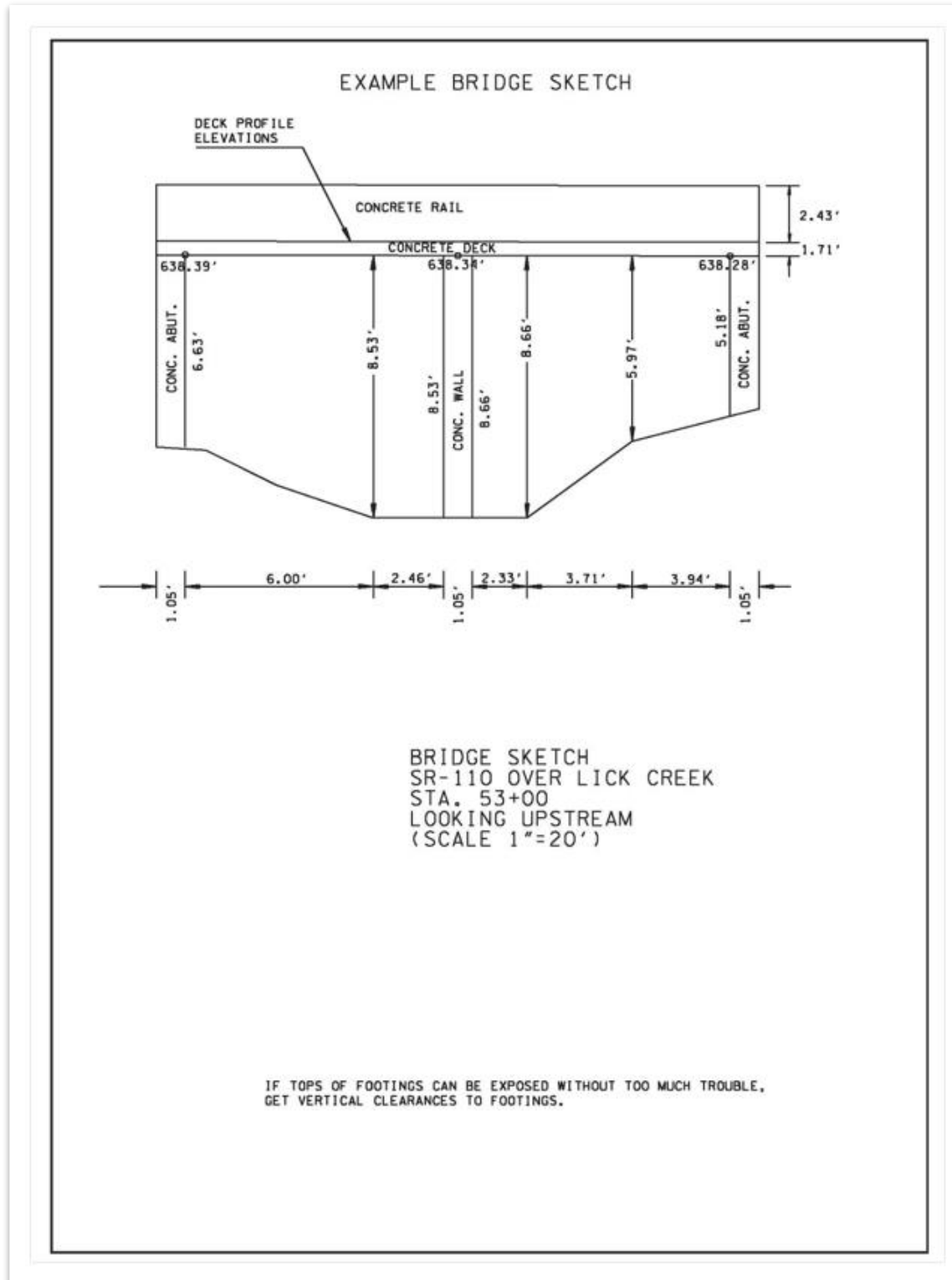

C.12.2 Example 2

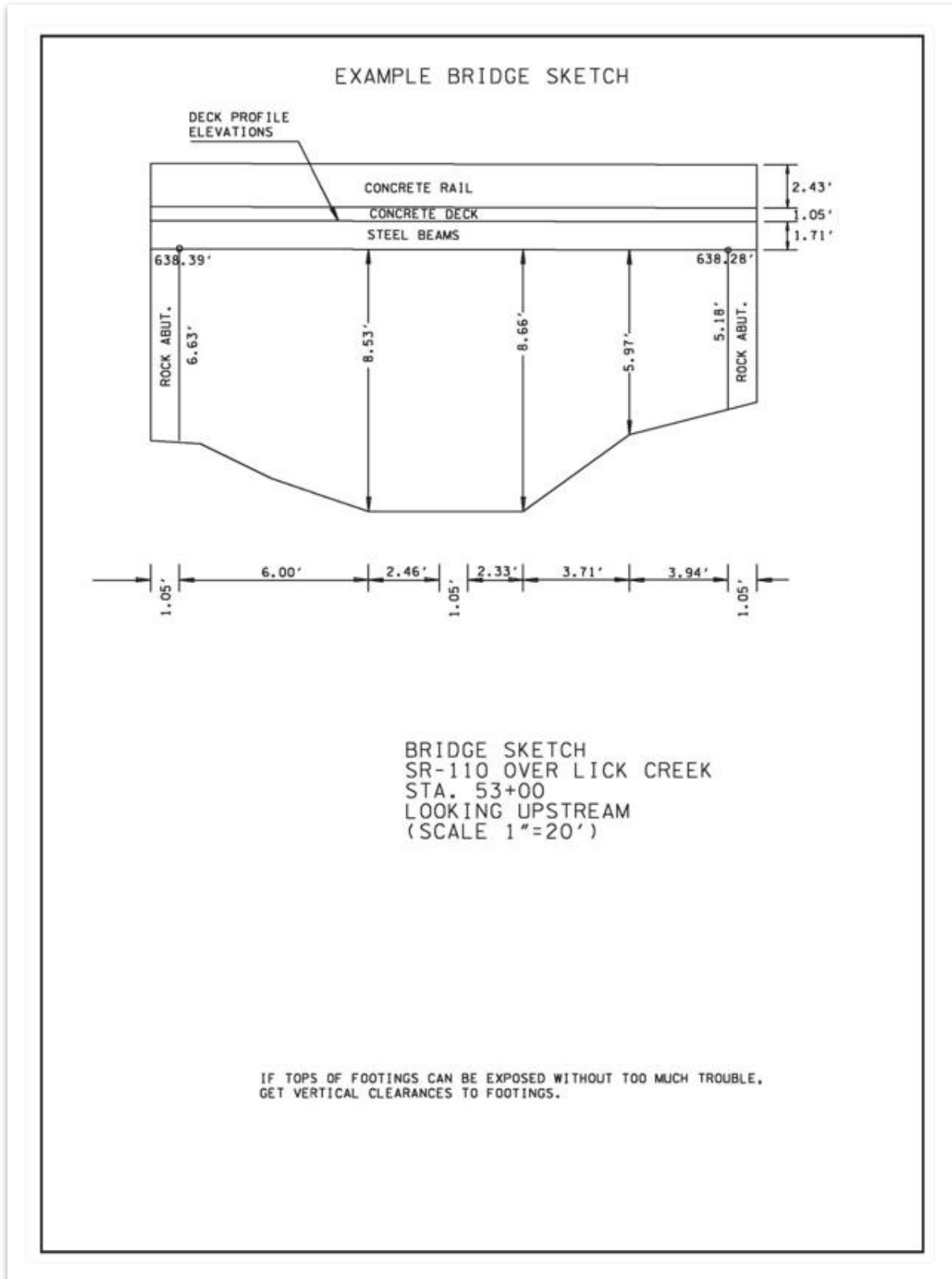

C.12.3 Example 3

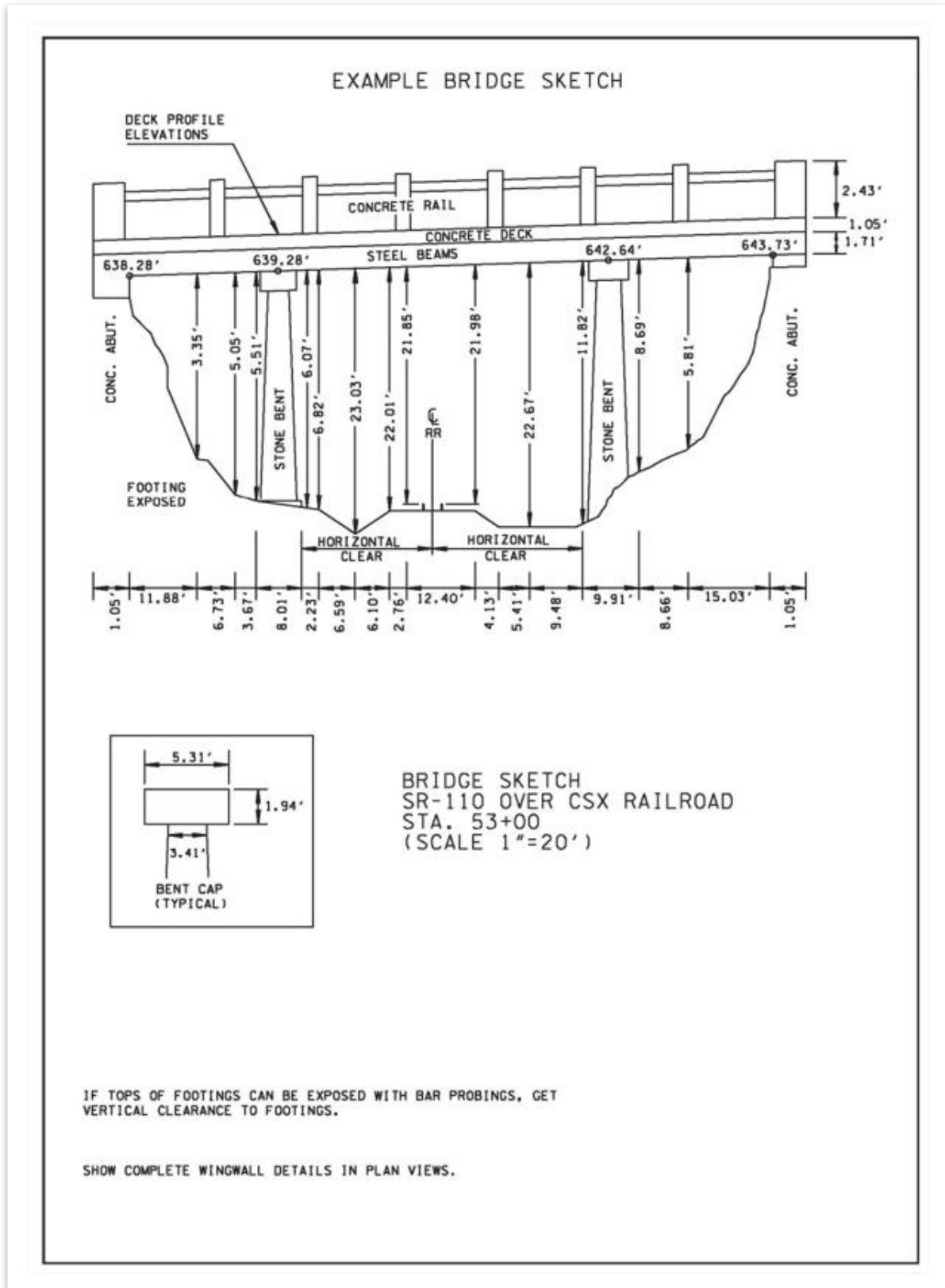

C.12.4 Example 4

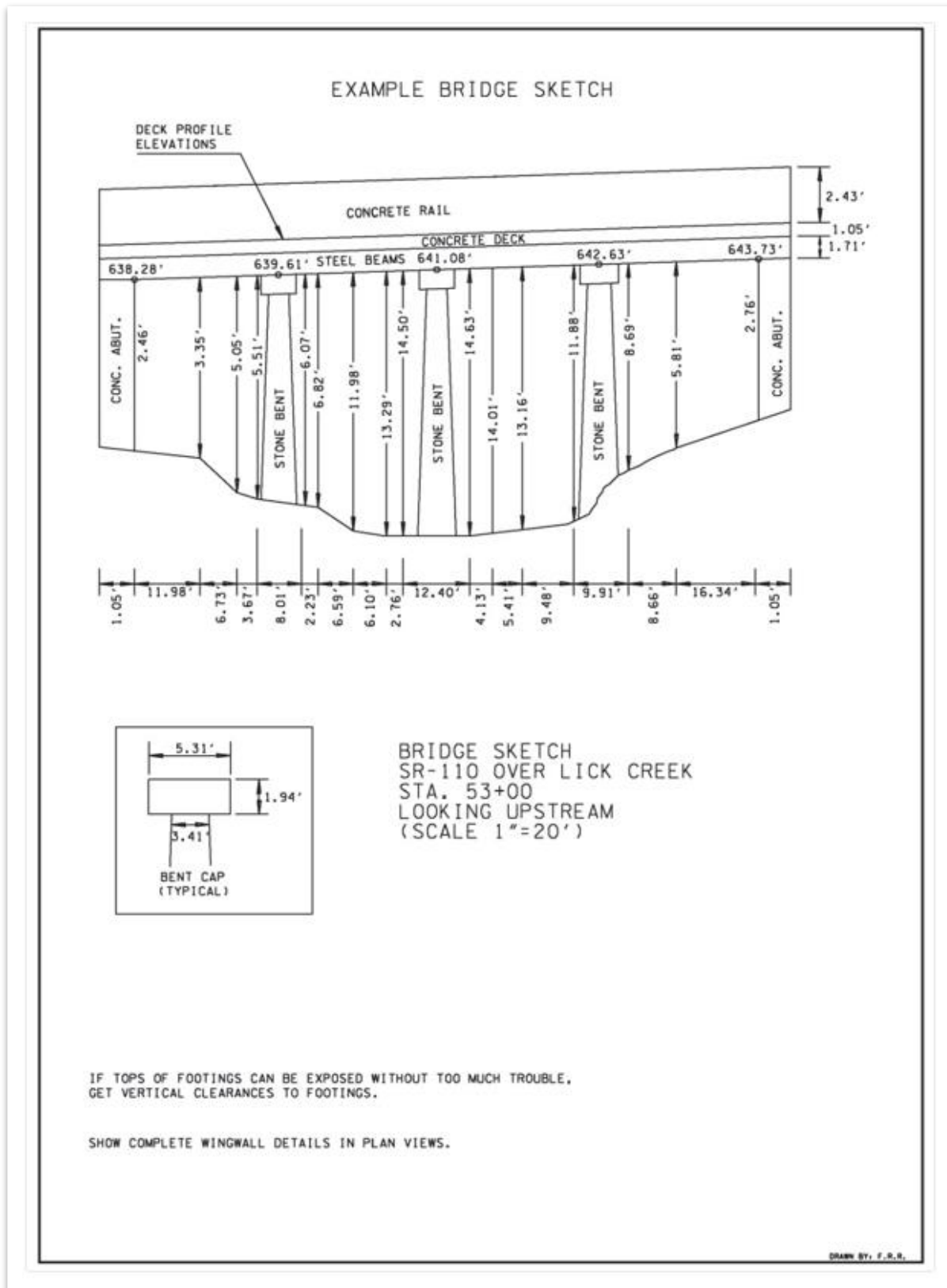

C.13 Surveying Methods

C.13.1 Traverse

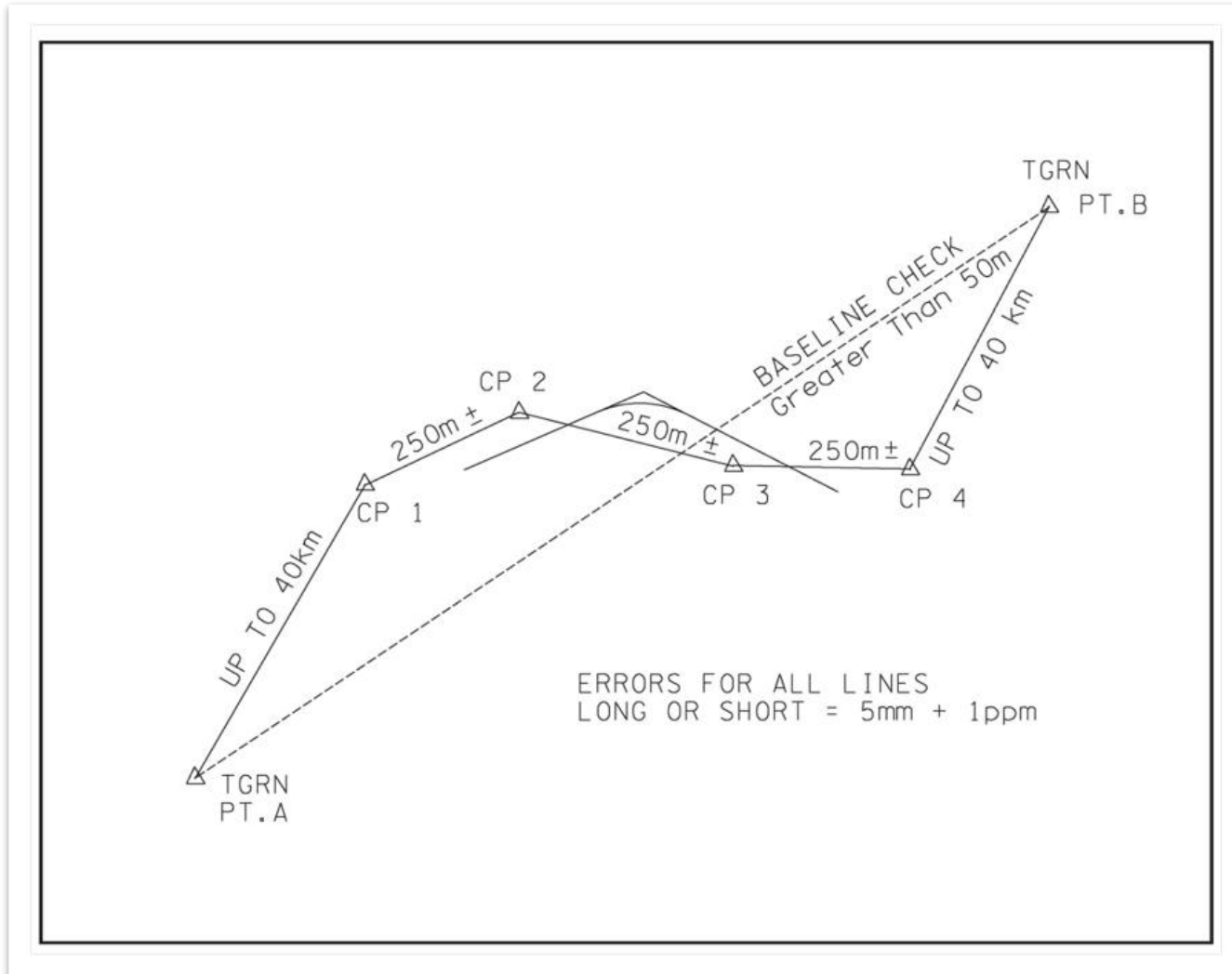

C.13.2 Wing Point

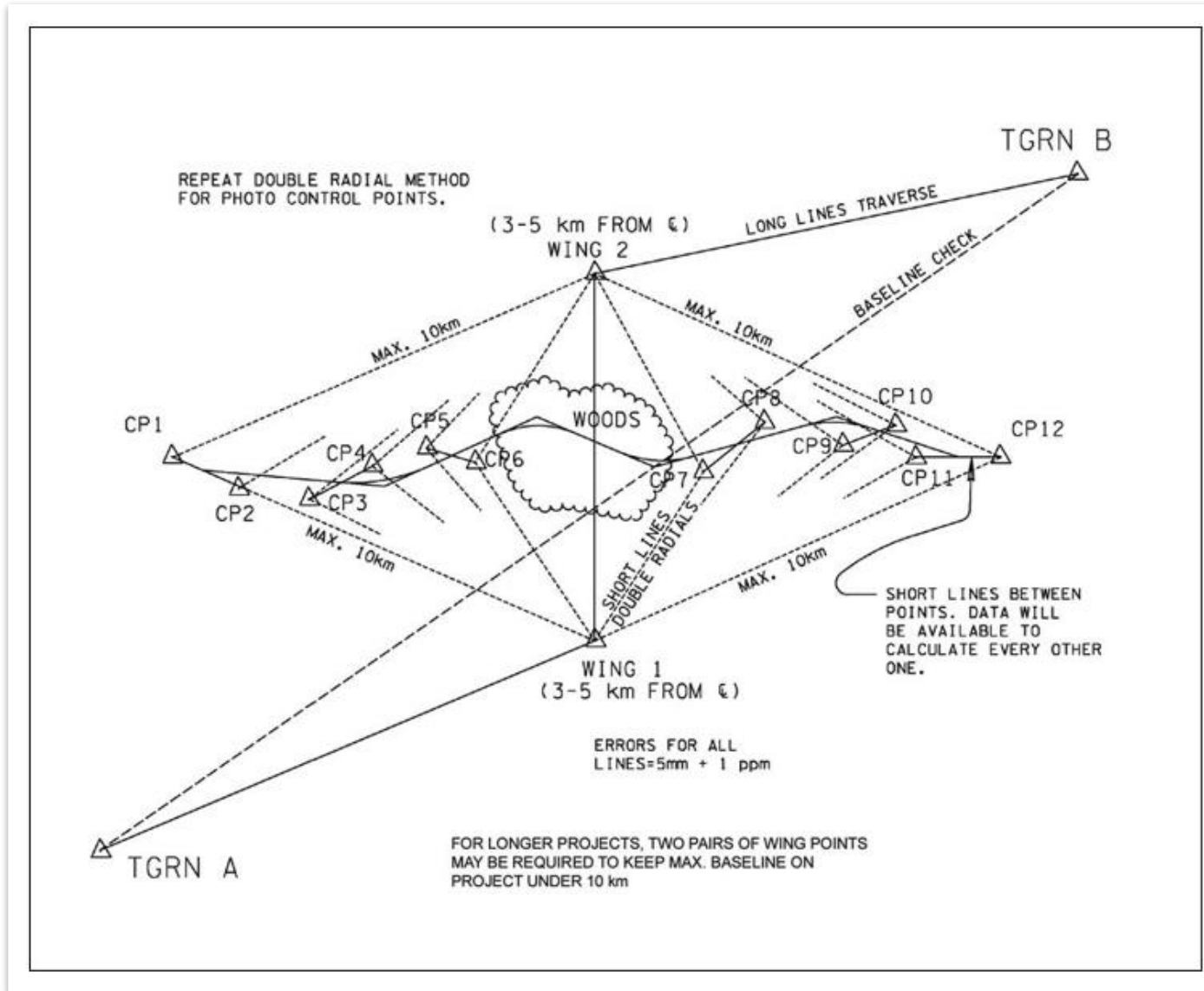

C.13.3 Modified Wing Point

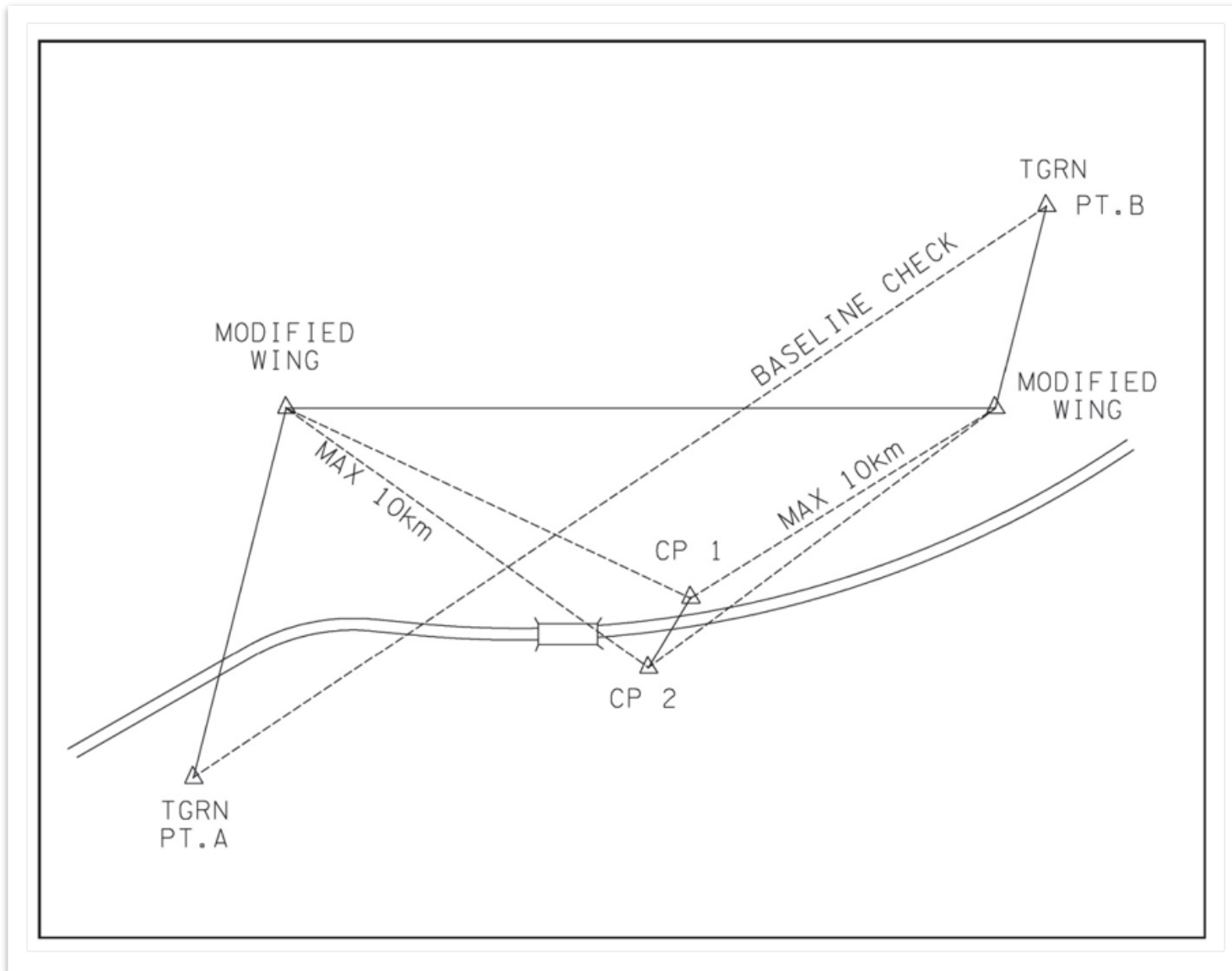

C.14 County Codes

<https://www.tn.gov/tdot/about/county-outline-map.html>

COUNTY CODES					
Region 1			Region 2		
ANDERSON	AN	01	BLEDSON	BS	04
BLOUNT	BT	05	BRADLEY	BR	06
CAMPBELL	CM	07	CANNON	CN	08
CARTER	CR	10	CLAY	CL	14
CLAIBORNE	CB	13	COFFEE	CF	16
COCKE	CO	15	CUMBERLAND	CU	18
GRAINGER	GG	29	DEKALB	DK	21
GREENE	GR	30	FENTRESS	FE	25
HAMBLETON	HB	32	FRANKLIN	FR	26
HANCOCK	HC	34	GRUNDY	GD	31
HAWKINS	HK	37	HAMILTON	HT	33
JEFFERSON	JF	45	JACKSON	JK	44
JOHNSON	JN	46	McMINN	MM	54
KNOX	KN	47	MARION	MA	58
LOUDON	LO	53	MEIGS	ME	61
MONROE	MR	62	OVERTON	OV	67
MORGAN	MG	65	PICKETT	PI	69
ROANE	RO	73	POLK	PO	70
SCOTT	SC	76	PUTNAM	PU	71
SEVIER	SE	78	RHEA	RH	72
SULLIVAN	SL	82	SEQUATCHIE	SQ	77
UNICOI	UC	86	VAN BUREN	VB	88
UNION	UN	87	WARREN	WR	89
WASHINGTON	WS	90	WHITE	WH	93

COUNTY CODES					
Region 3			Region 4		
BEDFORD	BD	02	BENTON	BN	03
CHEATHAM	CT	11	CARROLL	CA	09
DAVIDSON	DV	19	CHESTER	CH	12
DICKSON	DS	22	CROCKETT	CK	17
GILES	GI	28	DECATUR	DE	20
HICKMAN	HI	41	DYER	DY	23
HOUSTON	HO	42	FAYETTE	FA	24
HUMPHREYS	HU	43	GIBSON	GB	27
LAWRENCE	LW	50	HARDEMAN	HM	35
LEWIS	LE	51	HARDIN	HD	36
LINCOLN	LI	52	HAYWOOD	HW	38
MACON	MC	56	HENDERSON	HS	39
MARSHALL	MS	59	HENRY	HY	40
MAURY	MU	60	LAKE	LK	48
MONTGOMERY	MT	63	LAUDERDALE	LD	49
MOORE	MO	64	McNAIRY	MN	55
PERRY	PE	68	MADISON	MD	57
ROBERTSON	RB	74	OBION	OB	66
RUTHERFORD	RF	75	SHELBY	SH	79
SMITH	SM	80	TIPTON	TI	84
STEWART	ST	81	WEAKLEY	WE	92
SUMNER	SU	83			
TROUSDALE	TR	85			
WAYNE	WA	91			
WILLIAMSON	WM	94			
WILSON	WI	95			

C.15 Hydrologic Areas

C.15.1 Example 1

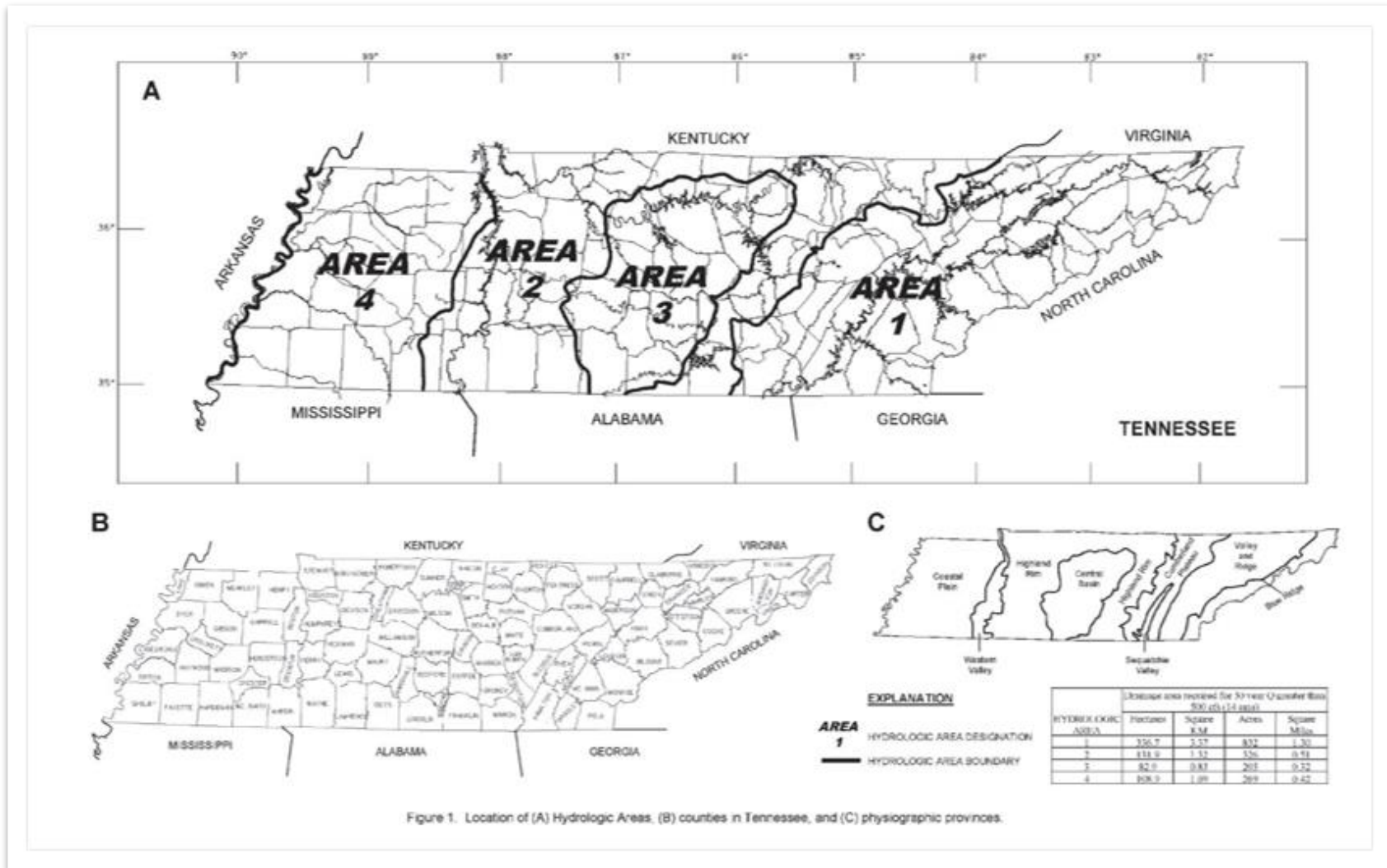

C.16 Roadway Breakline Placement

C.16.1 Two Lane-Two Way Example

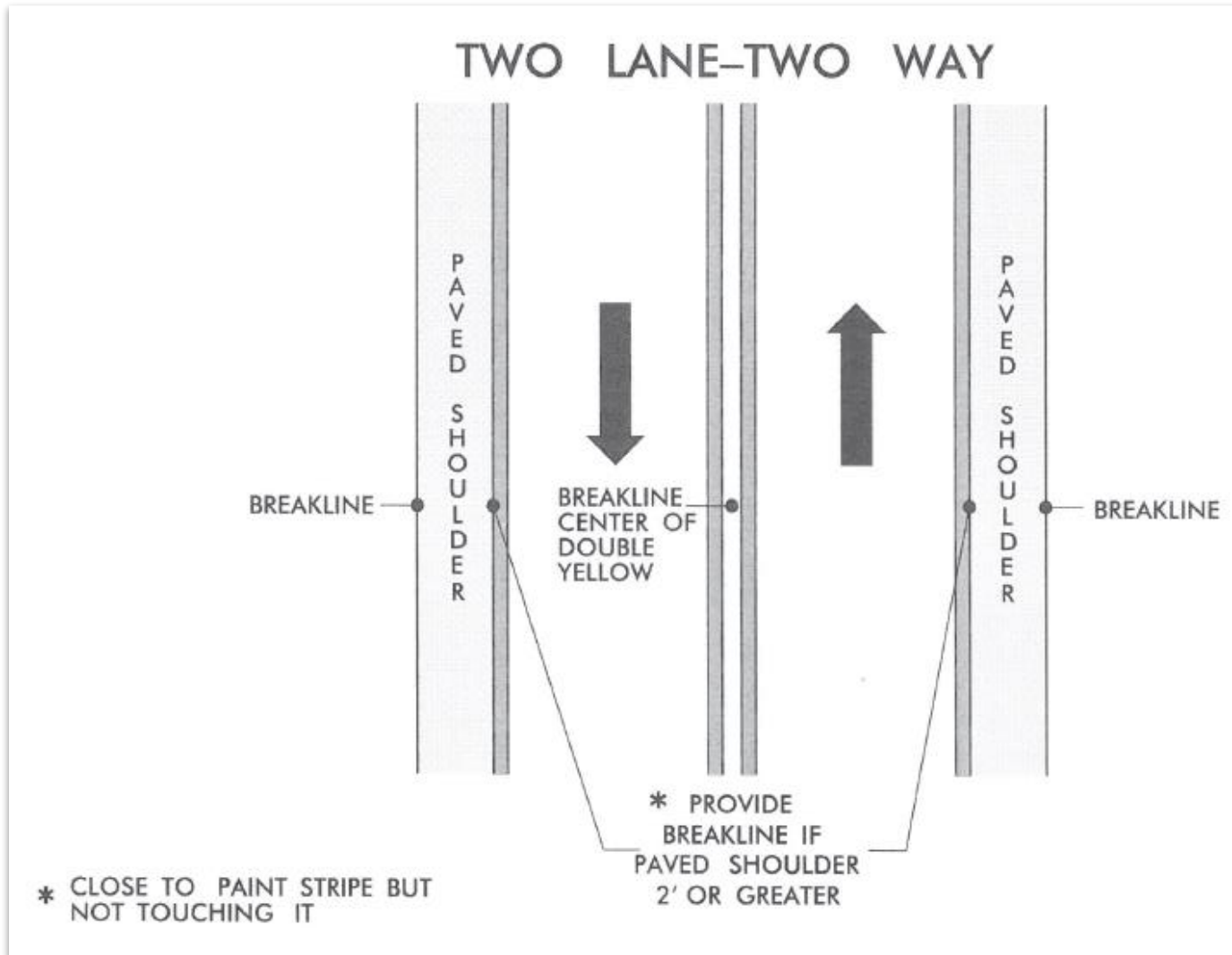

C.16.2 Multilane Divided Example

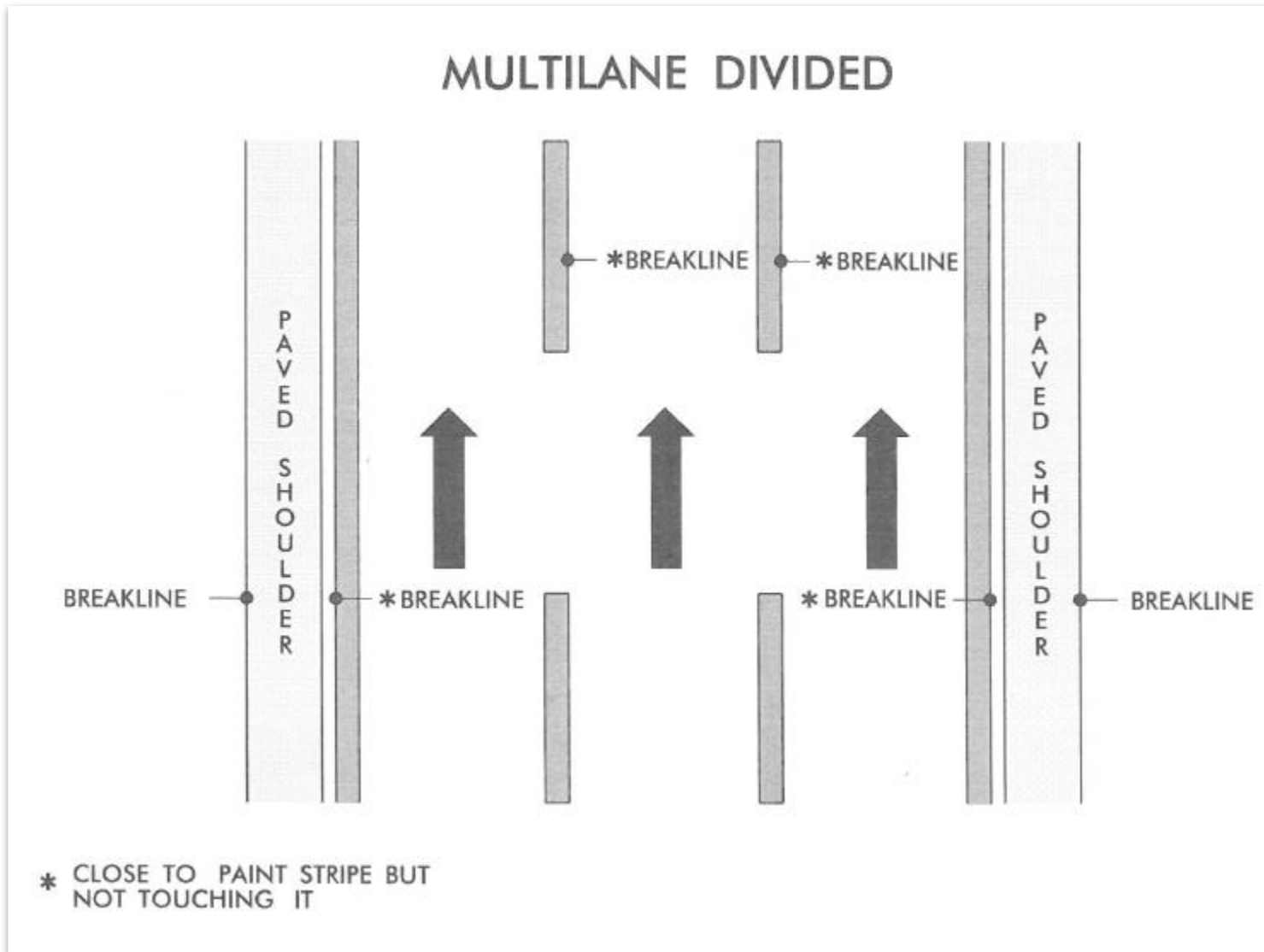

C.17 QA/QC Reports

C.17.1 TLS Checklist

Materials recommended before scanning:

- Purpose of mapping project? TDOT Project Number: _____
- Project Manager name: _____
- Map Units: U.S. Survey Foot International Foot Metric
- Control: TLS Conventional
- Project Datum: Horizontal (including epoch) and Vertical _____
- Scanner calibration report (dated).
- Proposed scanner control plan.
- Proposed scanner occupation plan.
- Proposed validation points.
- Proposed schedule for delivery of Item B and C materials to the district.

Materials recommended after scanning and registration and before feature extraction:

- The Project Control Report
- The Project QC Report ([Section 7.1.5.6](#))
 - TLS registration reports that contain registration errors reported from the registration software.
 - Elevation comparisons of two or more point clouds from overlapping scan area (Table 9 in [Section 7.1.6.2](#)).
 - Statistical comparison of point cloud data and redundant control point(s) if available.
 - Statistical comparison of registered point cloud data with check / validation points from conventional surveys if available.
- Registered point cloud (LAS, LAZ, ASTM E57, or other specified format files).
- Georeferenced digital photographs, if available.

Materials recommended after feature extraction has been completed:

- Registered point cloud (LAS, LAZ, ASTM E57, or other specified format files).
- Georeferenced digital photographs, if available.
- CADD files.
- 3D printing technology physical scale models of the subject, if required.
- Survey control report.
- Survey narrative report.
- QC report.

C.17.2 MLS Checklist

Materials recommended before the MLS data collection:

- Purpose of mapping project? TDOT Project Number: _____
- Project Manager name: _____
- Map Units: U.S. Survey Foot International Foot Metric
- Control: MLS Conventional
- Project Datum: Horizontal (including epoch) and Vertical _____
- Scanner(s) alignment calibration report (dated).
- Proposed drive route plan.
- Pre-op MLS vehicle check.
- GNSS satellite visibility and PDOP forecasts.
- Proposed GNSS base station locations.
- Quality Management Plan
- MLS control target plan including target spacing and control target layout diagram.
- Proposed schedule for delivery of Item B and C materials to the district.
- Name and contact information of the MLS operator.

Materials recommended after the data collection and registration and before feature extraction:

- MLS QC report should contain the following:
 - The GNSS/IMU post-processing accuracy report.
 - Registration report.
 - QC results.
- List of required features to be extracted and survey request with project limit.
- Registered point cloud (LAS, LAZ, or other specified format files) with description of each file with file name, readme.txt file, kml file, or shp file.
- Georeferenced digital photographs with data files supported by TopoDOT.
- MLS Raw data files, if requested.
- Control point file(s).
- Conventional survey data files(s).
- Survey narrative report including description of any anomalies.
- Survey control report.

Materials recommended after feature extraction:

- All items in MLS checklist.
- Current TDOT Roadway design and TDOT drafting software files.

C.18 Point Cloud Deviation Map Example

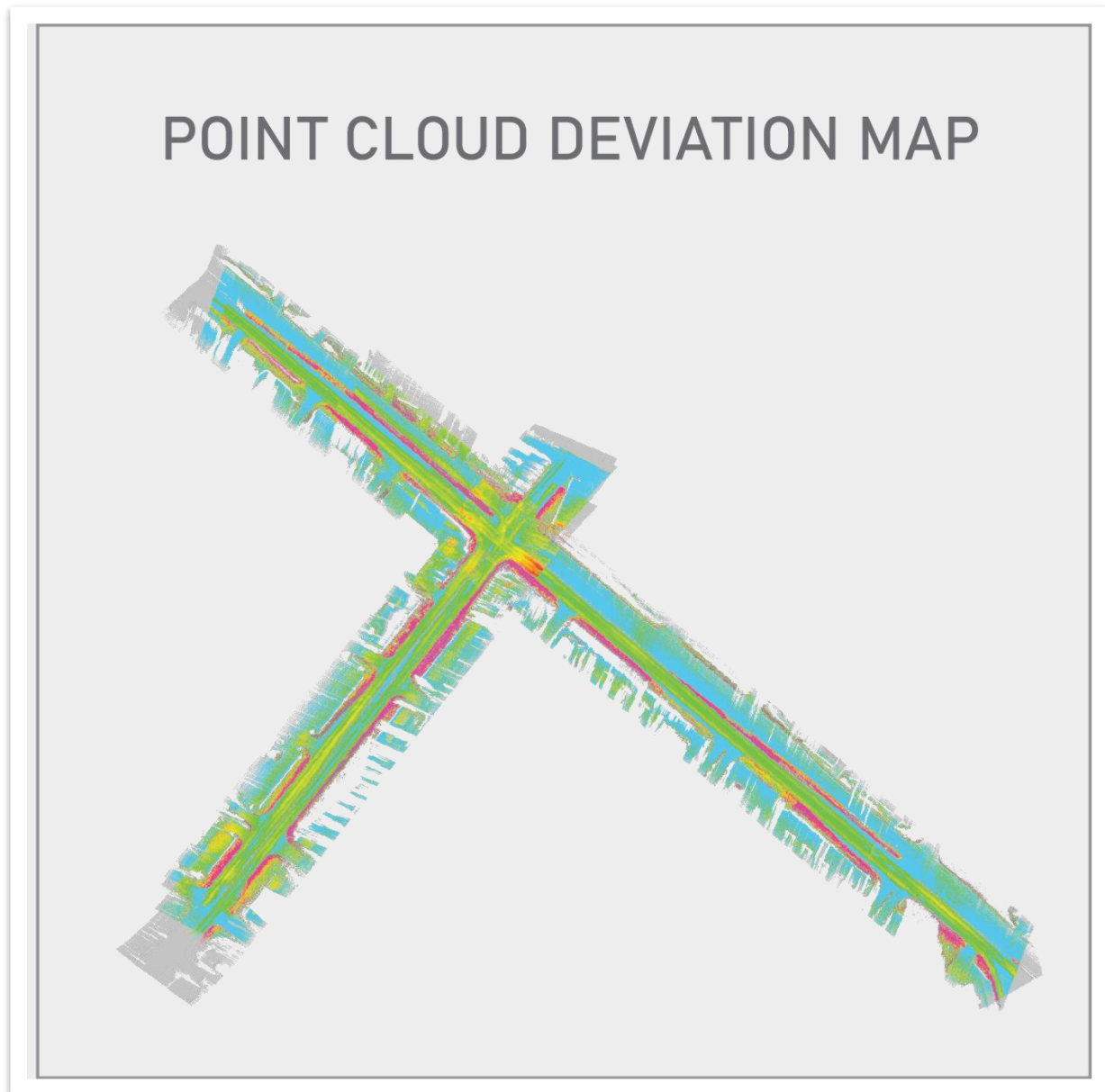

Note: Point cloud deviation maps will differ between programs. The above map represents a general example of a deviation map.

C.19 RMSE Report Example

R.M.S.E. REPORT EXAMPLE

Index	Point	Easting	Northing	Elevation	Abs(Deviation X)	Deviation X	Abs(Deviation Y)	Deviation Y	Abs(Deviation Z)	Deviation Z	Dist XY	Template Name
0	P-1	1519775.5780	473242.6030	650.5870	0.0220	-0.0220	0.0480	0.0480	0.0010	0.0010	0.0530	18x4 Cross
1	P-2	1519829.5300	473308.7110	650.5900	0.0350	-0.0350	0.0250	0.0250	0.0030	-0.0030	0.0430	18x4 Cross
2	P-3	1519995.7860	473080.0890	649.2210	0.0390	-0.0390	0.0130	0.0130	0.0010	-0.0010	0.0410	18x4 Cross
3	P-4	1520630.6260	473093.4210	648.4930	0.0350	0.0350	0.0160	-0.0160	0.0010	0.0010	0.0380	18x4 Cross
4	P-5	1520559.0710	472231.7600	641.1800	0.0020	-0.0020	0.0170	0.0170	0.0030	0.0030	0.0170	18x4 Cross
5	P-6	1520486.9150	472706.7790	644.6000	0.0020	-0.0020	0.0140	0.0140	0.0130	-0.0130	0.0140	18x4 Cross
6	P-7	1520572.6490	472591.5300	644.7890	0.0190	0.0190	0.0080	0.0080	0.0030	-0.0030	0.0210	18x4 Cross
7	P-8	1520686.5390	472406.1510	644.3250	0.0050	0.0050	0.0350	0.0350	0.0070	-0.0070	0.0360	18x4 Cross
8	P-9	1521454.2320	471781.9460	642.6320	0.0090	0.0090	0.0130	0.0130	0.0010	0.0010	0.0160	18x4 Cross
9	P-10	1521540.0610	471622.2960	640.4230	0.0010	0.0010	0.0130	0.0130	0.0060	-0.0060	0.0130	18x4 Cross
10	P-11	1521593.7840	471690.2350	640.4350	0.0280	-0.0280	0.0050	-0.0050	0.0040	-0.0040	0.0290	18x4 Cross
11	P-12	1532616.9000	461418.2010	611.1800	0.0050	-0.0050	0.0280	0.0280	0.0010	0.0010	0.0280	18x4 Cross
12	P-13	1532878.1830	461392.8540	615.8510	0.0020	-0.0020	0.0270	-0.0270	0.0050	-0.0050	0.0270	18x4 Cross
13	P-14	1532754.8130	461274.0700	615.9460	0.0140	-0.0140	0.0090	0.0090	0.0010	0.0010	0.0160	18x4 Cross
14	P-15	1532464.8770	460950.7040	610.4370	0.0340	0.0340	0.0020	0.0020	0.0030	0.0030	0.0340	18x4 Cross
15	P-16	1532089.1570	460955.7510	615.4740	0.0190	0.0190	0.0130	-0.0130	0.0040	0.0040	0.0230	18x4 Cross
16	P-17	1533116.7610	460970.5650	615.5890	0.0110	0.0110	0.0120	-0.0120	0.0010	0.0010	0.0160	18x4 Cross
17	P-18	1533949.0410	462005.0040	591.3250	0.0160	0.0160	0.0210	0.0210	0.0010	-0.0010	0.0260	18x4 Cross
18	P-19	1532119.2890	460515.9030	615.9600	0.0200	0.0200	0.0150	-0.0150	0.0040	0.0040	0.0250	18x4 Cross
19	P-20	1522343.2420	471004.8460	618.2570	0.0010	-0.0010	0.0420	0.0420	0.0030	0.0030	0.0420	18x4 Cross
AVG						0.001		0.01		-0.001		
RMSE						0.0203		0.0222		0.0044		
Within Tolerance (%)						100		100		100		

