

INTERCHANGE MODIFICATION STUDY



***Interstate 40
and
Spence Lane
Davidson County
Nashville, Tennessee***

***PREPARED BY
THOMAS, MILLER & PARTNERS
BRENTWOOD, TENNESSEE
FOR
THE TENNESSEE DEPARTMENT OF TRANSPORTATION
PLANNING DIVISION***

April 2002



**STATE OF TENNESSEE
DEPARTMENT OF TRANSPORTATION
PLANNING DIVISION
SUITE 900, JAMES K. POLK BUILDING
505 DEADERICK STREET
NASHVILLE, TENNESSEE 37243-0334**

June 12, 2002

Mr. Jim Moore, Manager 2
Program Development and Scheduling Office
Suite 600, James K. Polk Building
Nashville, TN 37243-0341

SUBJECT: Interchange Modification Request for Interstate 40 at Spence Lane,
Davidson County

Dear Mr. Moore:

I am enclosing a copy of a letter dated June 7, 2002, from Mr. Mark Doctor, FHWA Field Operations Team Leader. Based on FHWA's engineering review of the subject study, the proposed modification is considered operationally acceptable. Final approval of the modification may be given upon completion of the National Environmental Policy Act (NEPA) procedures.

The contents of this study can be easily viewed by accessing the Planning Division's planning report database.

This information is being provided for your use in determining priorities, establishing future scheduling and initiating further development of the project.

If you need further information, please advise.

Sincerely,

Matthew L. Ashby, P.E.
TDOT - Facilities Planning Office

cc: Bill Moore, Dennis Cook, Jim Zeigler, Jim Jeffers, Ed Wasserman, Ralph Comer, John Tidwell, Jeff Jones, Jim Bryson, Mike Phillips, Ronnie Porter, Jerry Moorhead, Bill Hart, Carolyn Stonecipher, Tom Clinard (Clinard Engineering Associates), File



U.S. Department
of Transportation
**Federal Highway
Administration**

Tennessee Division Office
640 Grassmere Park
Nashville, TN 37211

June 7, 2002

Mr. Dennis Cook
Assistant Chief Engineer for Planning
Tennessee Department of Transportation
Nashville, Tennessee 37243-0349

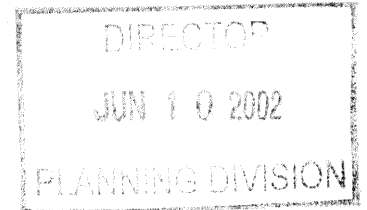

Dear Mr. Cook:

Subject: Interchange Modification Request for Interstate 40 at Spence Lane
Davidson County

An Interchange Modification Study and request for approval of revised Interstate access was submitted for the subject project. The existing I-40 and Spence Lane interchange is a partial interchange with access only provided to Spence Lane from the westbound direction of I-40. The recommended improvement includes the addition of a new ramp on the southern side of I-40 to provide access from Spence Lane onto I-40 eastbound. The proposal also includes removing the existing westbound Murfreesboro Road ramp to eastbound I-40. Removal of this ramp will eliminate a poor merge movement through a portion of the I-40/24/440 interchange area.

Based on an engineering review of the Interchange Modification Study, the proposed modification is considered operationally acceptable. Final approval of the modifications may be given upon completion of the National Environmental Policy Act (NEPA) procedures.

Sincerely,

Mark A. Doctor
Field Operations Team Leader

TABLE OF CONTENTS

Chapter 1	Page
Introduction	
A. Purpose of Study	1
B. Project Location and Description of Area	1
C. Relationship to Other Transportation Plans And Programs	6
Chapter 2	
Preliminary Planning Data	
A. Land Use	7
B. Traffic Served	8
C. Proposed Modifications	9
D. Discussions of Initial Concepts	11
E. Environmental Concerns	11
Chapter 3	
Engineering Investigations	
A. Traffic Operations	12
B. Access Analysis	15
C. Proposed Interchange Design Cost	17
Chapter 4	
Summary of Findings and Conclusions	18
Appendix	

MAPS

Figure 1: Vicinity Map	2
Figure 2: Project Location Map	3
Figure 3: U.S.G.S. Map	4

PHOTOS

Photo 1: Eastbound I-40 West of Spence Lane	5
Photo 2: Westbound I-40 West of Spence Lane	5
Photo 3: Northbound Spence Lane South of I-40	6
Photo 4: I-24 to I-40 with Eastbound Murfreesboro Road Ramp	7
Photo 5: I-24 to I-40 with Westbound Murfreesboro Road Ramp	8
Photo 6: Proposed Ramp Location	9

APPENDIX

Appendix A: Traffic Volumes: 2003 and 2023 DHV's
Appendix B: Level of Service: Existing and Proposed
Appendix C: Capacity Analysis: Existing Conditions
Appendix D: Capacity Analysis: Proposed Modifications
Appendix E: Cost Estimates
Appendix F: Functional Plans
Appendix G: Background Information

CHAPTER 1

Introduction

A. Purpose of Study

The purpose of this study is to evaluate the existing interchange at Interstate 40 and Spence Lane, and to request approval for the modification of this interchange. This study was conducted to:

- Determine any operational deficiencies in the current interchange.
- Develop the needed interchange improvements to provide an acceptable desired level of service for the design year.
- Improve the access and safety within the interchange area.
- Evaluate operational characteristics of the proposed improvements for the current conditions (2003) and the design year (2023).
- Develop construction cost estimates and evaluate the land use impacts of the construction.

This study was performed at the request of Nashville Metropolitan Government and in close cooperation with the Tennessee Department of Transportation.

B. Project Location and Description of the Area

The I-40 & Spence Lane interchange is located in the southeastern portion of downtown Nashville, east of the I-40/24/440 interchange area as shown in Figure 1. The interchange is located along I-40 approximately 0.3 miles east of the I-40/24/440 multi-directional interchange and 1.4 miles west of the SR-155 (Briley Parkway) interchange.

This section of Interstate 40 is currently a six-lane median-divided access controlled facility within the vicinity of the Spence Lane interchange. Design plans are currently being developed to widen this section of I-40 to ten travel lanes. As part of this widening project, several ramp modifications to the multi-directional interchange to the west will also be done. These design plans also include widening the existing structure on Spence Lane over I-40 to accommodate a five lane section in the future. Significant modifications to the I-40 & SR-155 (Briley Parkway) interchange are also in the design phase, as a separate project.

The existing I-40 and Spence Lane interchange is a partial interchange with access only provided to Spence Lane from the westbound direction. Any access to and from the west of Spence Lane is constrained due to the close proximity of the I-40/24/440 directional interchange (See Photo1 and 2).

This segment of interstate is one of the most heavily traveled sections in the city of Nashville with over 119,000 vehicles per day. The average daily traffic (ADT) is anticipated to grow to nearly 150,000 vehicles in the design year of 2023. A large percentage (10% ADT) of this volume is truck traffic.

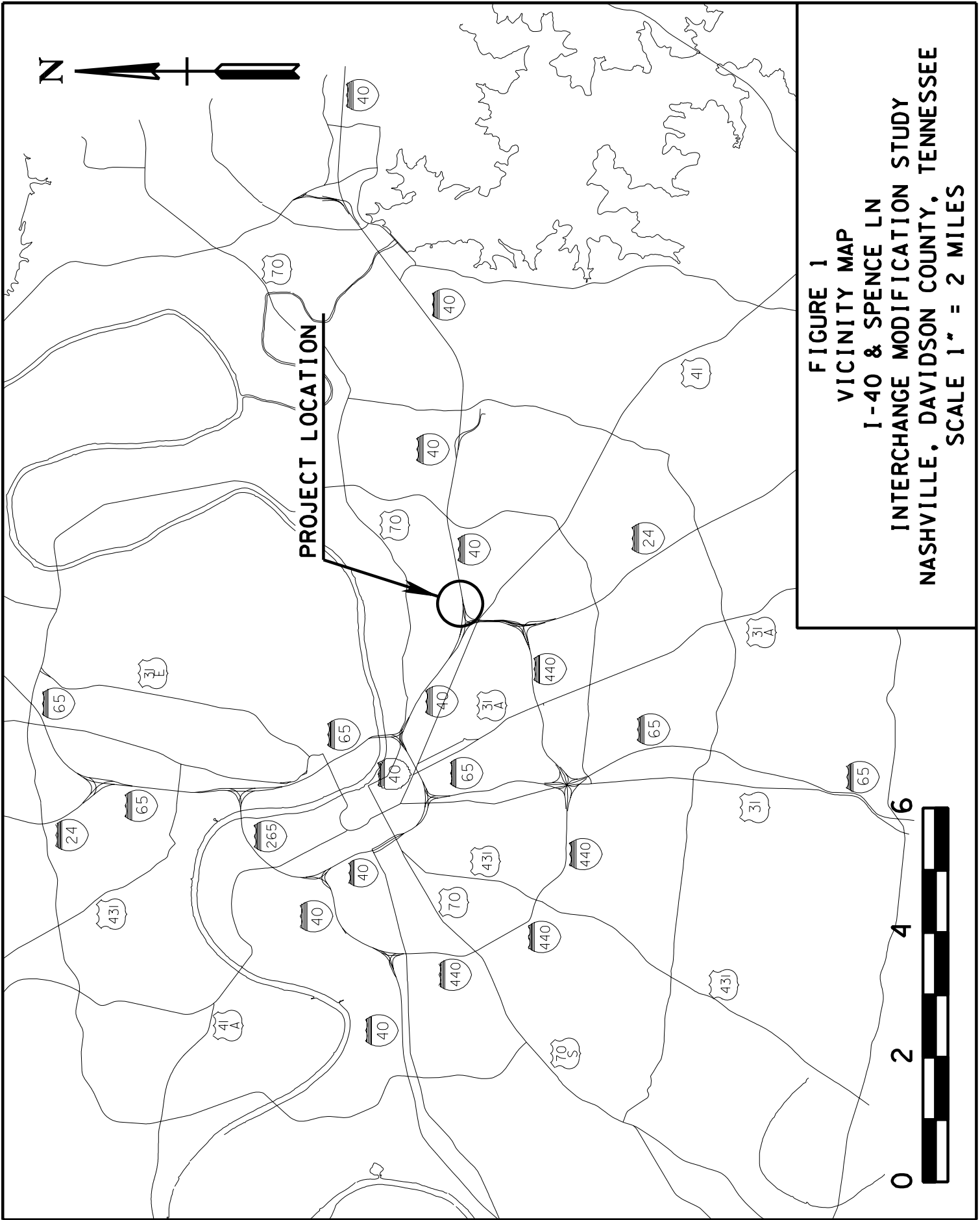

FIGURE 1
VICINITY MAP
I-40 & SPENCE LN
INTERCHANGE MODIFICATION STUDY
NASHVILLE, DAVIDSON COUNTY, TENNESSEE
SCALE 1" = 2 MILES

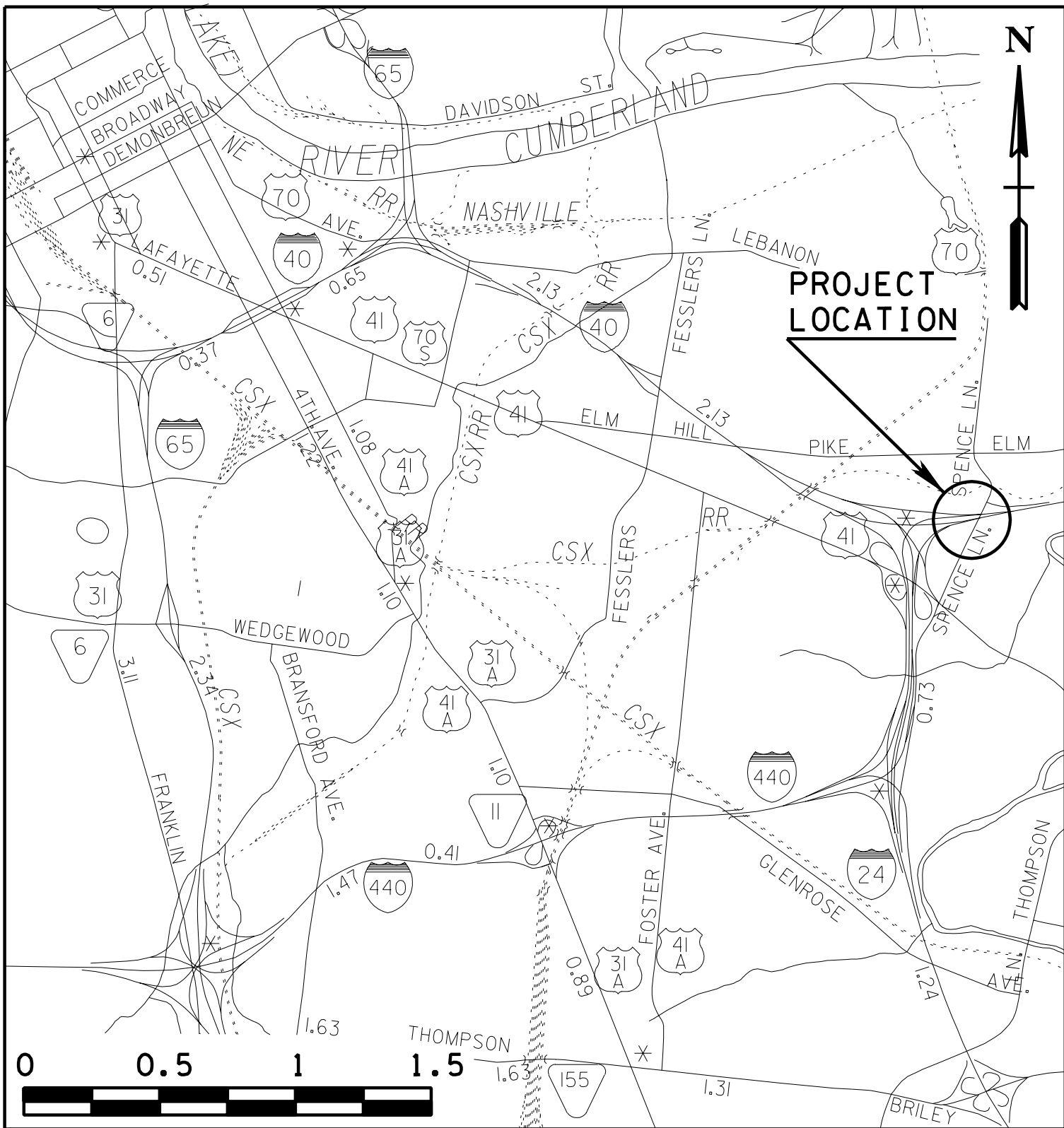

FIGURE 2
I-40 & SPENCE LN.
INTERCHANGE MODIFICATION STUDY
NASHVILLE, DAVIDSON COUNTY, TENNESSEE
SCALE 1" = ½ MILE

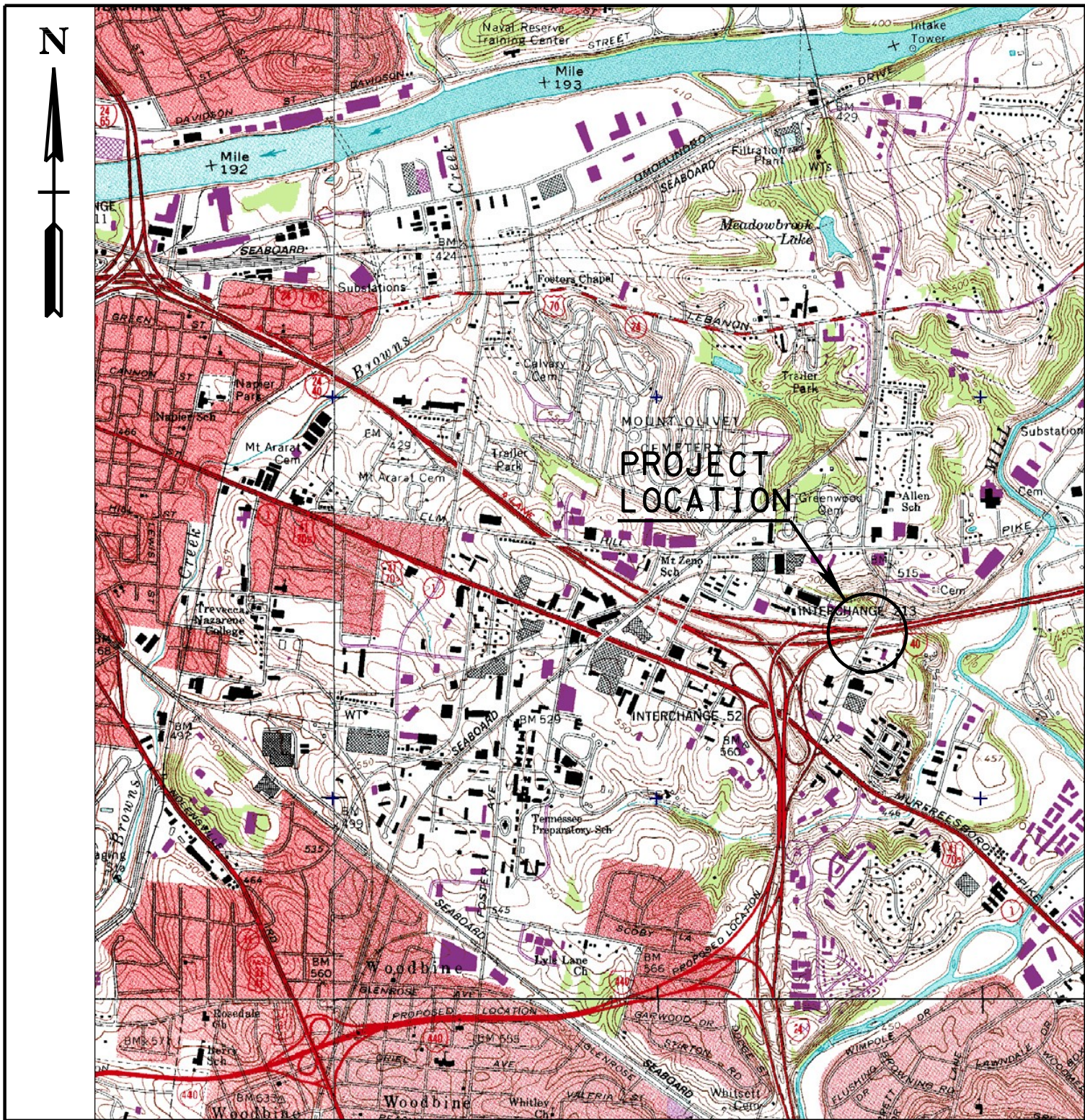

FIGURE 3
 I-40 & SPENCE LN.
 INTERCHANGE MODIFICATION STUDY
 USGS "NASHVILLE EAST" QUAD
 NASHVILLE, DAVIDSON COUNTY, TENNESSEE
 SCALE 1" = 2000 FT.

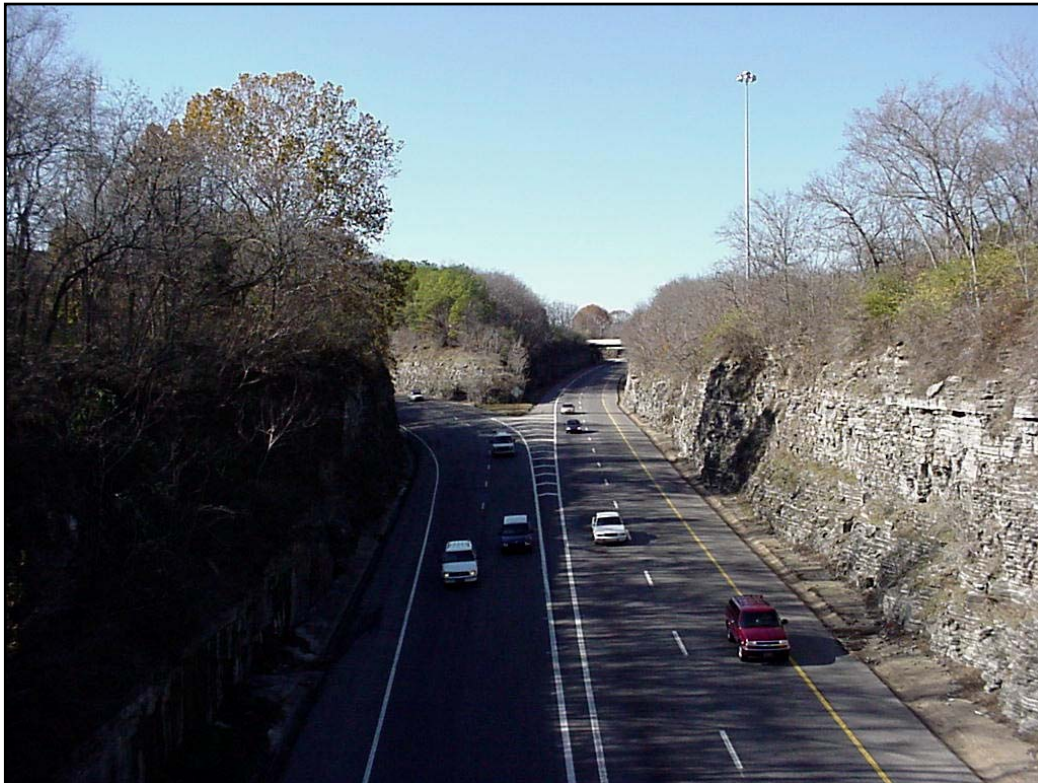

Photo 1: Eastbound I-40 West of Spence Lane



Photo 2: Westbound I-40 West of Spence Lane

C. Relationship to Other Highway Improvement Programs and Plans

As stated previously, there are design plans underway to widen I-40 from the I-40/24/440 interchange, east to SR-155 (Briley Parkway) with significant improvements to the I-40 and Briley Parkway interchange.

The Nashville Metropolitan Long-Range Plan calls for interchange improvements at this location (I-40 & Spence Lane). Included in the long-range plan, is the widening of Spence Lane from SR-1 (Murfreesboro Road) to SR-24 (Lebanon Pike) from a two-lane facility to four travel lanes with a center left-turn lane (Photo 3).

There are also preliminary plans to provide commuter rail from the central business district of Nashville towards the east (Lebanon) at some point in the future.



Photo 3: Northbound Spence Lane, south of I-40 Overpass

CHAPTER 2

Preliminary Planning Data

A. Land Use

Various industrial and commercial developments lie in close proximity to the interchange area, as well as along the Elm Hill Pike and Murfreesboro Road corridors. Several hotels and motels are near the subject interchange area as well.

Because the current configuration of the I-40 and Spence Lane interchange provides for only one movement or access point (I-40 westbound), motorists are forced to traverse through the I-40/24/440 directional interchange to return to the east. This return movement is comprised of several merge/diverge maneuvers within a short distance, which creates a less than desirable situation for motorists. The following photos illustrate the close spacing and reduced sight distance for some of these movements.



Photo 4: I-24 to I-40 with EB Murfreesboro Road Entrance Ramp



Photo 5: I-24 to I-40 with WB Mufreesboro Road Entrance Ramp

B. Traffic Served

The traffic data for this study was supplied by the Tennessee Department of Transportation (TDOT) and was based on proposed land use and existing conditions. The Design Hourly Volumes (DHV) for the years 2003 and 2023 are shown in Appendix A.

Interstate 40 is currently a six-lane section between the adjacent interchanges of the I-40/24/440 interchange to SR-155. The year 2003 peak hour volumes are over 7,000 vehicles per hour in each direction. In the design year (2023), the DHV's are anticipated to grow to approximately 9,000 vehicles per hour in each direction.

The figures in Appendix A provide a complete breakdown of traffic volumes for the subject interchange and the adjacent interchange for the base year (2003) and the design year (2023).

C. Proposed Modifications

Based upon study of various alternatives to improving this interchange, it was determined that the recommended improvements provide a comprehensive solution to the access and safety concerns initially outlined at the beginning of this study. The proposed modifications for the I-40 and Spence Lane interchange will improve traffic operations, safety and access within the subject area.

In order to provide a return movement for those motorists presently using the existing exit ramp to Spence Lane, a proposed new access point is planned. This new ramp will be located on the southern side of I-40 and will require significant retaining walls and excavation of rock material to construct. The photo below shows the densely wooded and rough terrain where this new ramp will be located.



Photo 6: Proposed ramp location (Spence Lane to I-40 Eastbound)

It is anticipated that two businesses will need to be relocated and additional right-of-way acquired to construct this ramp. It appears that both the auto sales and Insty Prints located along the eastside of Spence Lane will need to be acquired. While the cost for acquiring Insty Prints has been included in the overall estimate, it may be possible to restore their access to Spence Lane through an inter-parcel access agreement with RTS Wright Industries and avoid this total acquisition.

As stated previously in this study, the MPO Long-Range plan calls for Spence Lane to be widened from Murfreesboro Road to Lebanon Pike. This future widening will provide for four, twelve (12) foot travel lanes with a center turn lane

within the existing right of way (128'). The existing cross section is comprised of two lanes with shoulders and ditches. In order to widen this roadway within the limits of this modification study, three (3) retaining walls will be required along the eastside of Spence Lane to avoid impacting several businesses. To provide sufficient vertical sight distance, the crest vertical curve near the proposed entrance ramp will also need to be lowered.

The design plans underway for the widening of the interstate, also includes some minor modifications to the existing I-40 westbound exit ramp to Spence Lane. No significant modifications to this ramp are recommended in this study (Photo Below). Presently, there is an at-grade railroad crossing located north of the Spence Lane overpass at I-40. There are plans to abandon this rail line at some point in the future as well.



With the construction of this new ramp to eastbound I-40, removal of the existing westbound Murfreesboro ramp to eastbound I-40 can be performed. Removal of this ramp will eliminate this less than desirable merge movement for motorists that travel through this portion of the I-40/24/440 interchange area (See functional plans).

Operation of the ramp terminal intersections will be accomplished through the use of traffic signals. Due to the heavy left turn volumes for both of these intersections, unsignalized operation was not practical to provide an adequate level-of-service.

D. Discussion of Initial Concepts

Due to close proximity of the I-40/24/440 multidirectional interchange, none of the initial concepts provided the possibility of providing a full access interchange at Spence Lane.

Limitations of right-of-way along this corridor as well as the location of commercial establishments along the interstate also limited the array of options to providing full access to the area through the Spence Lane interchange.

With these two factors in mind, focus was placed upon providing the most practical and cost effective solution to access eastbound I-40, while attempting to reduce or improve the operation of the merge/diverge movements located within the directional interchange to the west.

Throughout the development of this study, several coordination and field review meetings were held involving the department, FHWA and Nashville Metropolitan Public Works. The City of Nashville expressed that they too agreed a full interchange at this location would be costly due to the close proximity of the multidirectional interchange to the west. All agencies also agreed that this project be coordinated with the planned widening of Spence Lane from Murfreesboro Road north to Lebanon Road and that the existing I-40 entrance ramp from Murfreesboro remain open during the construction phase.

E. Environmental Concerns

While detailed environmental technical studies were not conducted for this phase of the interchange study, visual investigations were done to identify site specific environmentally sensitive areas for historic, archeological and ecological considerations. At the current time, the recommended improvements do not appear to impact any areas of environmental or historical significance.

The Tennessee Department of Transportation will perform all necessary studies including detailed ecological and historical studies.

CHAPTER 3

Engineering Investigations

A. Traffic Operations

An initial analysis was made which determined that the existing interchange configuration was in adequate to handle design year volumes. Appendix B contains figures summarizing the levels-of-service under the existing conditions for 2003 and 2023 traffic. The levels-of-service were determined using the peak hour volumes which represent the worst case condition for each location.

Existing Roadway Network

All analysis for the existing roadway network assumed the widening of I-40 from the I-40/24/440 to SR-155 to be completed. Spence Lane's existing laneage (two travel lanes) was used for the analysis of the westbound exit ramp terminal intersection.

Ramp Junctions

The results of the capacity analyses conducted for the existing roadway network are shown in the following tables. As shown in Table 1, the ramp junction within the study area is projected to operate at poor LOS in the Year 2023, based on the existing roadway network.

TABLE 1

CAPACITY ANALYSES BASED ON THE EXISTING ROADWAY NETWORK

Ramp Junctions	Year 2003	Year 2023
Westbound I-40 & Spence Lane Exit (AM)	D	E
Westbound I-40 & Spence Lane Exit (PM)	C	D

Freeway Segments

The results of the capacity analyses for the freeway segments within the study area are shown in Table 2 on the following page. These results indicate that the widening currently under design will provide an acceptable LOS in the Year 2003, with two of the freeway segments projected to operate at a LOS E in 2023.

TABLE 2

CAPACITY ANALYSES BASED ON THE EXISTING ROADWAY NETWORK

Freeway Segments	Year	Year
	2003	2023
Eastbound I-40, east of Spence Lane (AM Peak Hour)	B	C
Eastbound I-40, east of Spence Lane (PM Peak Hour)	D	E
Westbound I-40, east of Spence Lane (AM Peak Hour)	D	E
Westbound I-40, east of Spence Lane (PM Peak Hour)	C	D

Surface Street Intersections

Capacity analyses were conducted for the existing laneage and traffic control that is located at the intersection of Spence Lane and the I-40 westbound exit ramp. This intersection currently operates as an unsignalized intersection. At this T-intersection, the northbound and southbound approach of Spence Lane includes one through lane with the westbound approach of the exit ramp comprised of one left turn lane and one right turn lane.

The results of these analyses are shown in Table 3. The analyses show that the existing intersection configuration will operate poorly during the AM peak hour in the base year (2003) and at a LOS F in the Year 2023.

TABLE 3

CAPACITY ANALYSES BASED ON THE EXISTING ROADWAY NETWORK

Surface Street Intersection (Unsignalized)	YEAR 2003		YEAR 2023	
	AM PEAK HOUR	PM PEAK HOUR	AM PEAK HOUR	PM PEAK HOUR
I-40 WB Exit Ramp & Spence Lane	E	C	F	F

PROPOSED ROADWAY NETWORK**Ramp Junctions**

The proposed improvements within the study area include the addition of a new entrance ramp from Spence Lane to eastbound I-40. With the addition of this new ramp, the existing entrance ramp from westbound Murfreeboro Road to eastbound I-40 would be eliminated (See Photo 4). Improvements also include the addition of traffic signals at both ramp terminal intersections on Spence Lane. As stated previously, the widening of Spence Lane to five travel lanes was also assumed to be complete. Based on these proposed improvements, additional analyses were conducted for the ramp junctions.

The results of the capacity analyses for the ramp junctions within the study area are shown in Table 4. These results indicate that, with the addition of the proposed eastbound ramp to I-40, the ramp junctions will operate at an acceptable LOS during the peak hours for both the base and design years.

TABLE 4

CAPACITY ANALYSES BASED ON THE PROPOSED IMPROVEMENTS

Ramp Junctions	Year 2003	Year 2023
Westbound I-40 & Exit Ramp to Spence Lane (AM)	D	E
Westbound I-40 & Exit Ramp to Spence Lane (PM)	C	D
Eastbound I-40 Entrance Ramp from Spence Lane (AM)	B	B
Eastbound I-40 Entrance Ramp from Spence Lane (PM)	B	C

Freeway Segments

Based on the proposed improvements, additional analyses were conducted for the freeway segments. The results of the capacity analyses for the freeway segments within the study area are shown in Table 5. These results indicate that the widened section of I-40 to ten travel lanes will operate at an acceptable LOS during both peak hours in the year 2003, with no segment operating at a LOS F in the design year.

TABLE 5

CAPACITY ANALYSES BASED ON THE PROPOSED IMPROVEMENTS

Freeway Segments	Year 2003	Year 2023
Westbound I-40, east of Spence Lane (AM Peak Hour)	D	E
Westbound I-40, east of Spence Lane (PM Peak Hour)	C	D
Eastbound I-40, east of Spence Lane (AM Peak Hour)	B	C
Eastbound I-40, east of Spence Lane (PM Peak Hour)	D	E

Surface Street Intersections

Based on the results of the analyses conducted for the existing laneage and traffic control at the intersection of Spence Lane and the westbound exit ramp from I-40, additional analyses were conducted for the proposed ramp to eastbound I-40. Both of these intersections were analyzed based upon signalized operation and the proposed laneage as shown in the functional plans.

The results of these analyses are shown in Table 6. The analyses show that the proposed improvements at these locations will provide an adequate LOS for both the base year and design year peak hours.

TABLE 6

CAPACITY ANALYSES FOR PROPOSED IMPROVEMENTS

Surface Street Intersections (Signalized)	YEAR 2003		YEAR 2023	
	AM PEAK HOUR	PM PEAK HOUR	AM PEAK HOUR	PM PEAK HOUR
I-40 EB Entrance Ramp & Spence Lane	A	A	A	A
I-40 WB Exit Ramp & Spence Lane	B	A	B	B

B. Access Analysis

This study has been undertaken in accordance with the Federal Highway Administration's (FHWA) policy for granting new or revised interchange access. The FHWA policy, as described in FHWA Docket 98-3460, "Additional Interchanges to the Interstate System (Federal Register 63, No. 28, February 11, 1998) is provided in the following paragraphs accompanied by comments for consideration.

It is in the national interest to maintain the Interstate System to provide the highest level of service in terms of safety and mobility. Adequate control of access is critical to providing such service. Therefore, new or revised access points to the existing Interstate System should meet the following requirements.

- 1. The existing interchanges and/or local roads and streets in the corridor can neither provide the necessary access nor be improved to satisfactorily accommodate the design year traffic demands while at the same time providing the access intended by the proposal.***

With the continual increase in traffic volumes along I-40 within the project area, the mainline, merge and diverge movements will continue to diminish the operation of the interstate system in the project area. This degradation will result in increased motorists delay, reduced traveler safety, and reduced air quality within the city of Nashville. No minor interchange improvements can be made (other than the recommended improvements) to eliminate the problems outlined previously in this report.

- 2. All reasonable alternatives for design options, location and transportation system management type improvements (such as ramp metering, mass transit and HOV facilities) have been assessed and provided for if currently justified, or provisions are included for accommodating such facilities if a future need is identified.***

Several design options were assessed in this study to improve the operation and access of the I-40 and Spence Lane interchange. However, the proposed

alternative is the only one that provided improved operational characteristics for the interchange within the constraints outlined previously in the report.

The proposed modification will be constructed with as little disruption as possible to the adjacent development in the area as any other design option investigated.

3. ***The proposed access point does not have a significant adverse impact on the safety and operation of the interstate facility based upon an analysis of current and future traffic. The operational analysis for existing conditions shall, particularly in urbanized areas, include an analysis of sections of interstate to an including at least the first adjacent existing or proposed interchange on either side. Crossroads and other roads and streets shall be included in the analysis to the extent necessary to assure their ability to collect and distribute traffic to and from the interchange with new or revised access points.***

The proposed modifications should not have any adverse impact on the safety and operation of the interstate facility. Safety and mobility will be improved with the addition of the proposed eastbound ramp to I-40 and with the modification of the ramp terminal intersections on Spence Lane to signalized operation. Elimination of the existing substandard merge ramp from westbound Murfreesboro Road to eastbound I-40 will also be performed as part of this improvement project.

4. ***The proposed access connects to a public road only and will provide for all traffic movements. Less than “full interchanges” for special purpose access for transit vehicles, for HOV’s, or into park and ride lots may be considered on a case-by-case basis. The proposed access will be designed to meet or exceed current standards for Federal-Aid projects on the Interstate System.***

The proposal is a modification of the existing partial interchange at Interstate 40 and Spence Lane. The proposed modification will provide a new access point to the mainline of the interstate. As stated previously, due to the close proximity of the I-24/40/440 directional interchange, full access can not be provided at this location. The proposed design will meet or exceed the American Association of State Highway and Transportation Officials (AASHTO) criteria.

5. ***The proposal considers and is consistent with local and regional land use and transportation plans. Prior to final approval, all requests for new or revised access must be consistent with the metropolitan and/or statewide transportation plan, as appropriate, the applicable provisions of 23 CFR part 450 and the transportation conformity requirements of 40 CFR parts 51 and 93.***

The study was coordinated with both the Tennessee Department of Transportation and Nashville Metropolitan Government. The proposal is consistent with all local, regional, and statewide land use and transportation plans.

6. ***In areas where the potential exists for future multiple interchange additions, all requests for new or revised access are supported by a comprehensive interstate network study with recommendations that address all proposed and desired access within the context of a long-term plan.***

There are no long-range plans for additional interchanges in this area. The existing interchanges provide adequate access to the subject area.

7. ***The request for a new or revised access generated by a new or expanded development demonstrates appropriate coordination between the development and related or otherwise required transportation system improvements***

This interchange modification is intended to correct operational inadequacies of the existing interchange configuration, as well as provide new access from the interchange area. The request is also generated based upon continued growth and development within the vicinity of the interchange.

8. ***The request for a new or revised access contains information relative to the planning requirements and the status of environmental processing of the proposal.***

The proposed modifications will be submitted to the TDOT Environmental Department to begin environmental studies at the time this report is submitted to the FHWA.

C. Proposed Interchange Cost

The total cost for modification of the I-40 and Spence Lane interchange is approximately \$3,947,000. A detailed estimated cost breakdown is shown in Appendix E.

CHAPTER 4**Summary of Findings and Conclusions**

The purpose of this study was to evaluate the existing interchange at Interstate 40 and Spence Lane and to develop proposed improvements to the interchange which could be constructed within current physical constraints and provide an acceptable level of service for the design year traffic.

The traffic analysis indicates that with the planned widening of I-40, within the subject area, will improve the operation of both the mainline and ramp junctions for the I-40 and Spence Lane interchange. Analyses also shows that the Spence Lane widening contained in the MPO Long-Range Plan, will also improve the overall operation of the existing and proposed ramp terminal intersections.

As stated previously in this study, with the proposed ramp in place, removal of the existing westbound Murfreesboro ramp to eastbound I-40 can be performed. Removal of this ramp will eliminate this less than desirable merge movement for motorists that travel through this congested portion of the I-40/24/440 interchange.

With the proposed improvements recommended, partial access to and from I-40 to the east will be accomplished. Traffic operations will be improved with many movements operating at a desirable level of service. These improvements will require additional right-of-way to construct, at an estimated cost of \$3,947,000.

APPENDIX A

TRAFFIC VOLUMES: 2003 AND 2023 DHV'S

TENNESSEE DEPARTMENT OF TRANSPORTATION
 MAPPING AND STATISTICS OFFICE
 TRAFFIC AND SAFETY PLANNING SECTION

RECEIVED (REV 3/26/98)

AUG 10 2001

PROJECT NO.: _____ ROUTE: I-40 @ SPENCE LANE
 COUNTY: DAVIDSON CITY: NASHVILLE
 PROJECT DESCRIPTION: INTERCHANGE MODIFICATION @ I-40 AND SPENCE LANE.

DIVISION REQUESTING:

MAINTENANCE SPECIAL DESIGN
 PLANNING STRUCTURES
 PROG. DEVELOPMENT & ADM. SURVEY & DESIGN
 PUBLIC TRANS. & AERO. OTHER _____
 YEAR PROJECT PROGRAMMED FOR CONSTRUCTION: _____
 PROJECTED LETTING DATE: _____

TRAFFIC ASSIGNMENT:

BASE YEAR		[SEE ATTACHMENTS]					DESIGN ROADWAY % TRUCKS		DESIGN AVERAGE DAILY LOADS	
ADT	YEAR	ADT	DHV	%	YEAR	DIR.DIST.	DHV	ADT	FLEX	RIGID
	2003				2023					

REQUESTED BY: NAME TOM CLINARD DATE 8-2-01
 DIVISION THOMAS MILLER & PARTNERS
 ADDRESS 5210 MARYLAND WAY, SUITE 200
 BRENTWOOD TN. 37027-5008

REVIEWED BY: STEVE ALLEN *Steve Allen* DATE 8-8-01
 TRANSPORTATION MANAGER 1
 SUITE 1000, JAMES K. POLK BUILDING

APPROVED BY: BONNIE H. BROTHERS *Bonnie A. Brothers* DATE 08-08-01
 TRANSPORTATION MANAGER 2
 SUITE 1000, JAMES K. POLK BUILDING

COMMENTS:

THIS PROJECT CLOSES EAST BOUND I-40 ON RAMP @ MURFREESBORO ROAD AND ADDS EAST BOUND I-40 ON RAMP @ SPENCE LANE.

THIS TRAFFIC TAKEN FROM A PREVIOUS PROJECT PREPARED FOR PLANNING DATED 2-16-00 AND IS THE PHASE 2 DELL COMPUTER TRAFFIC WITH THE CHANGES MENTIONED ABOVE.

DHV'S ARE NOT REQUIRED FOR SIDE ROADS LESS THAN 1000 ADT.

NOTE: FOR BRIDGE REPLACEMENT PROJECTS, ADLs ARE NOT REQUIRED FOR ADTs OF 1000 OR LESS AND PERCENTAGE OF TRUCKS OF 7% OR LESS.
 SEE ATTACHMENTS FOR TURNING MOVEMENTS AND/OR OTHER DETAILS.

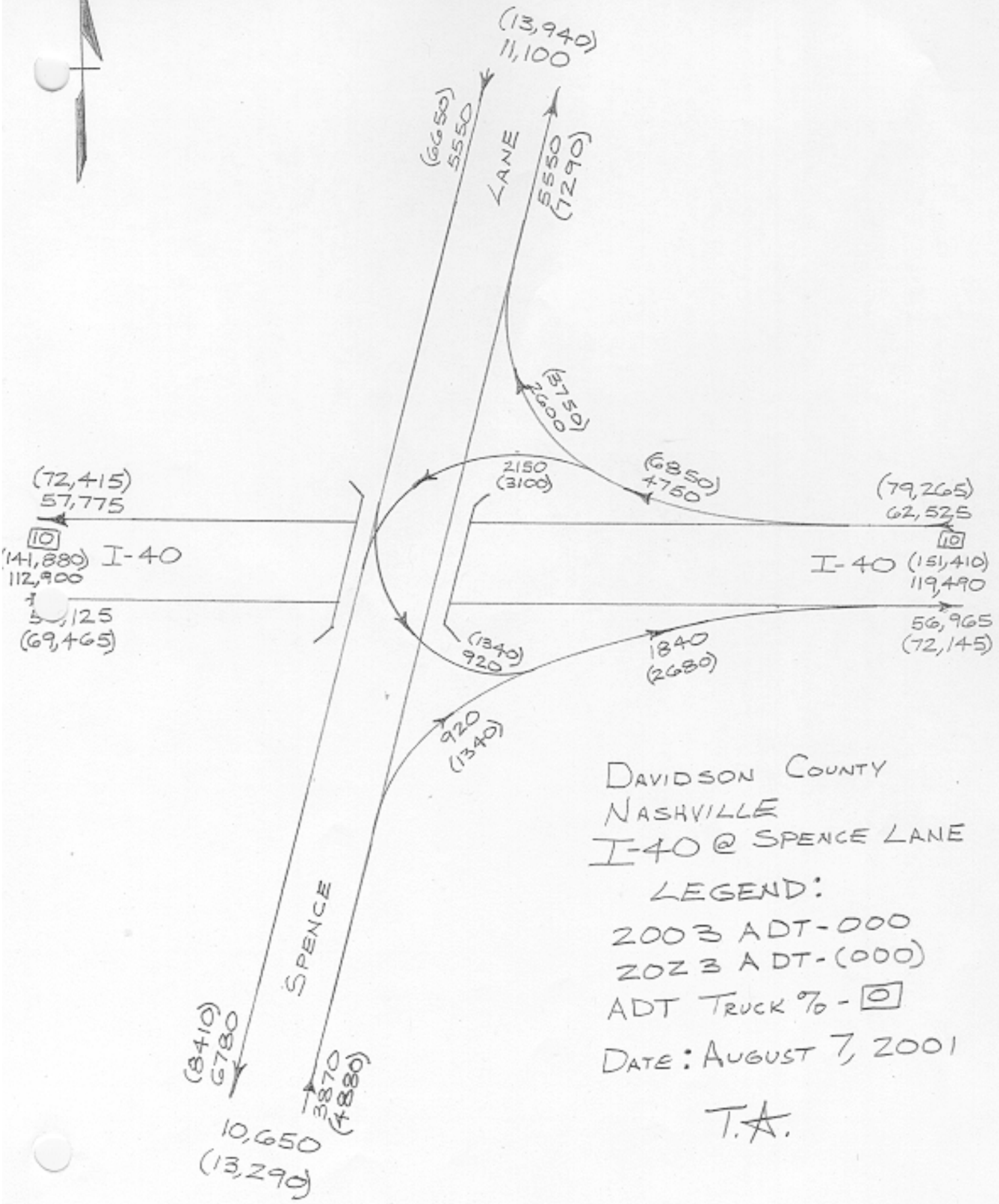

DAVIDSON COUNTY
NASHVILLE
I-40 @ SPENCE LANE

LEGEND:
2003 ADT - 000
2001 ADT - (000)
ADT TRUCK % -
DATE: AUGUST 7, 2001

T.A.

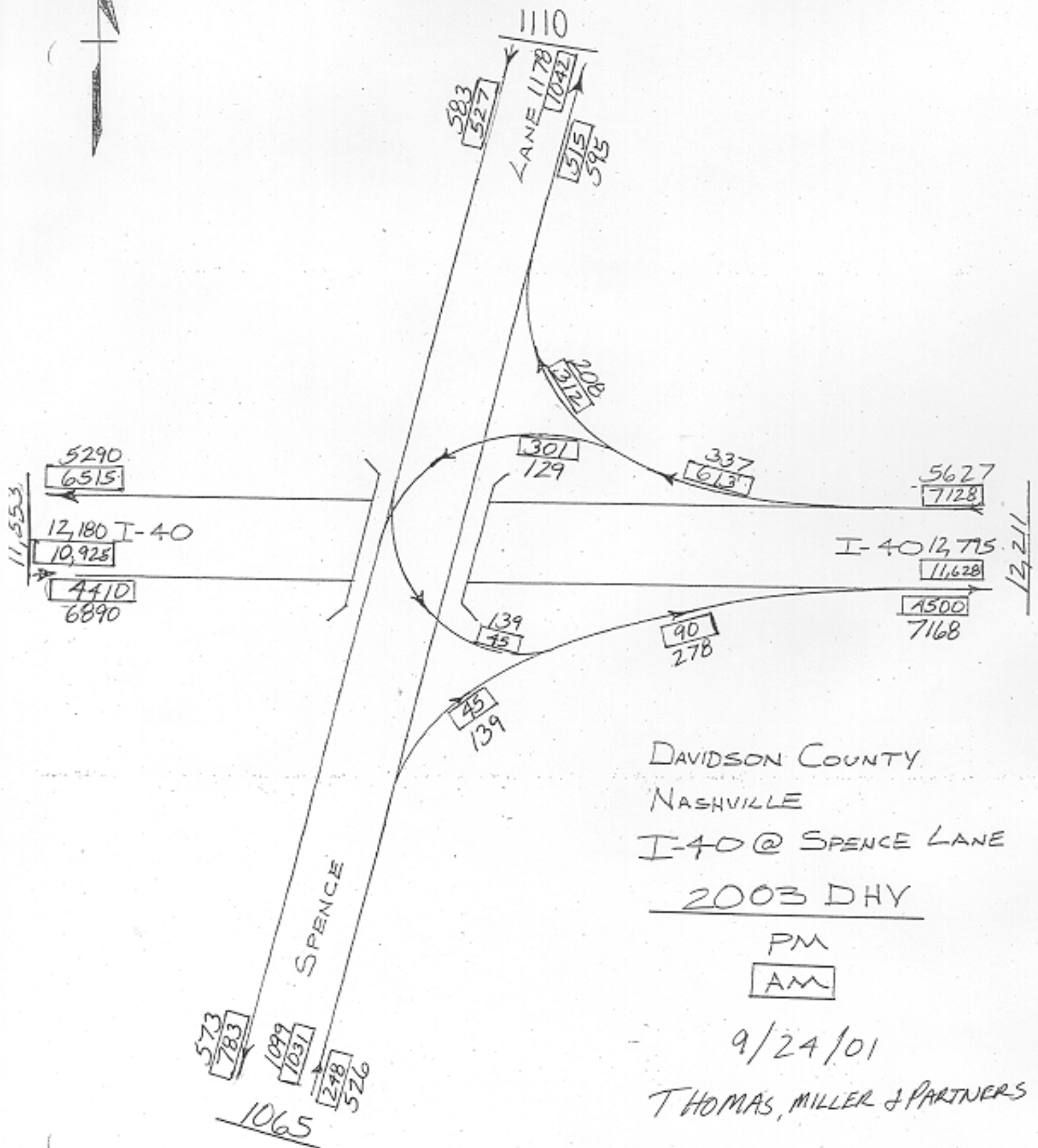

DAVIDSON COUNTY
 NASHVILLE
 I-40 @ SPENCE LANE
2003 DHV
 PM
 AM
 9/24/01
 THOMAS, MILLER & PARTNERS

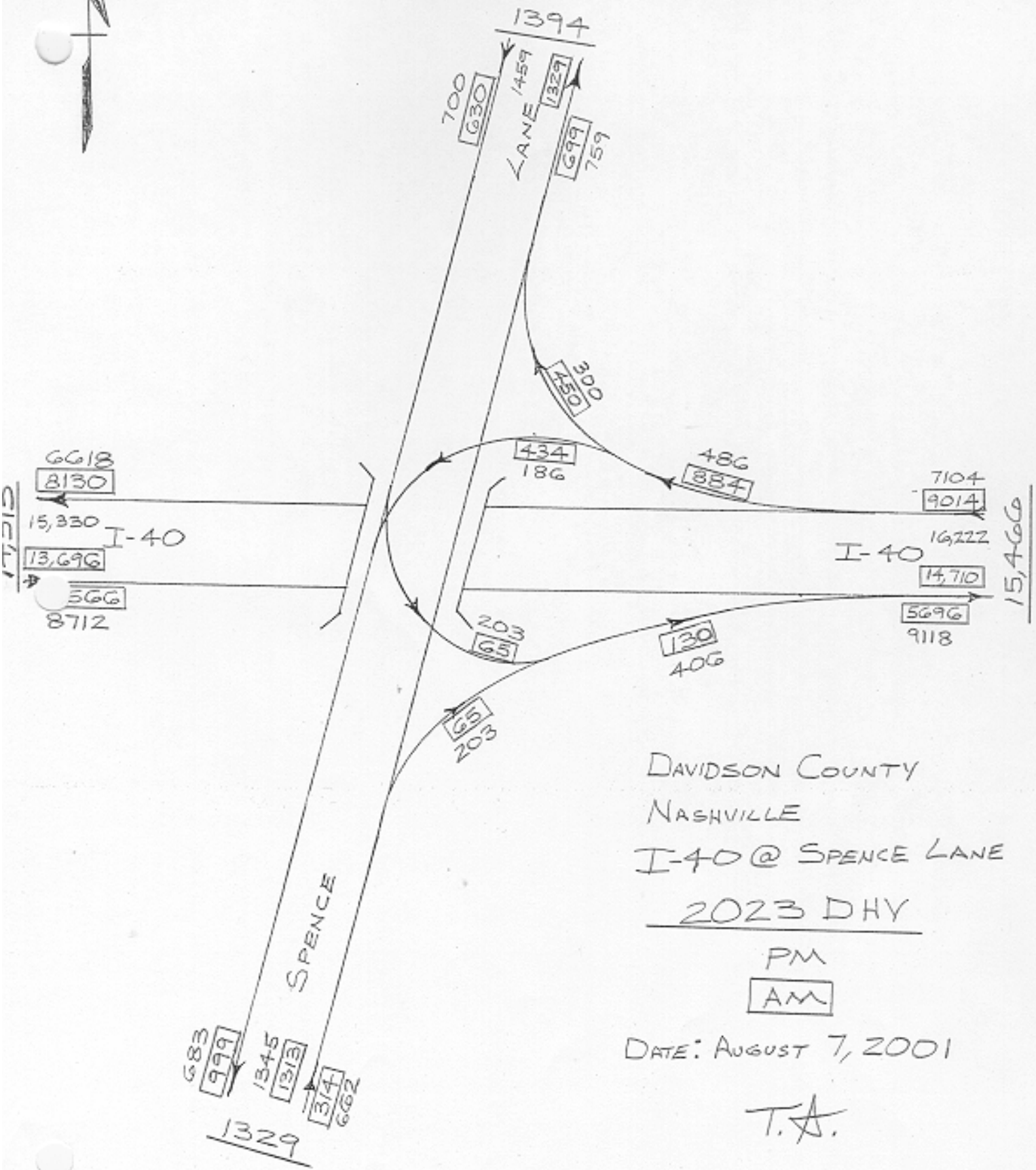

DAVIDSON COUNTY
 NASHVILLE
 I-40 @ SPENCE LANE
2023 DHV

PM
 AM

DATE: AUGUST 7, 2001

T.A.

①



ADT's
PROP. SYSTEM
w/DELL PHASE 2

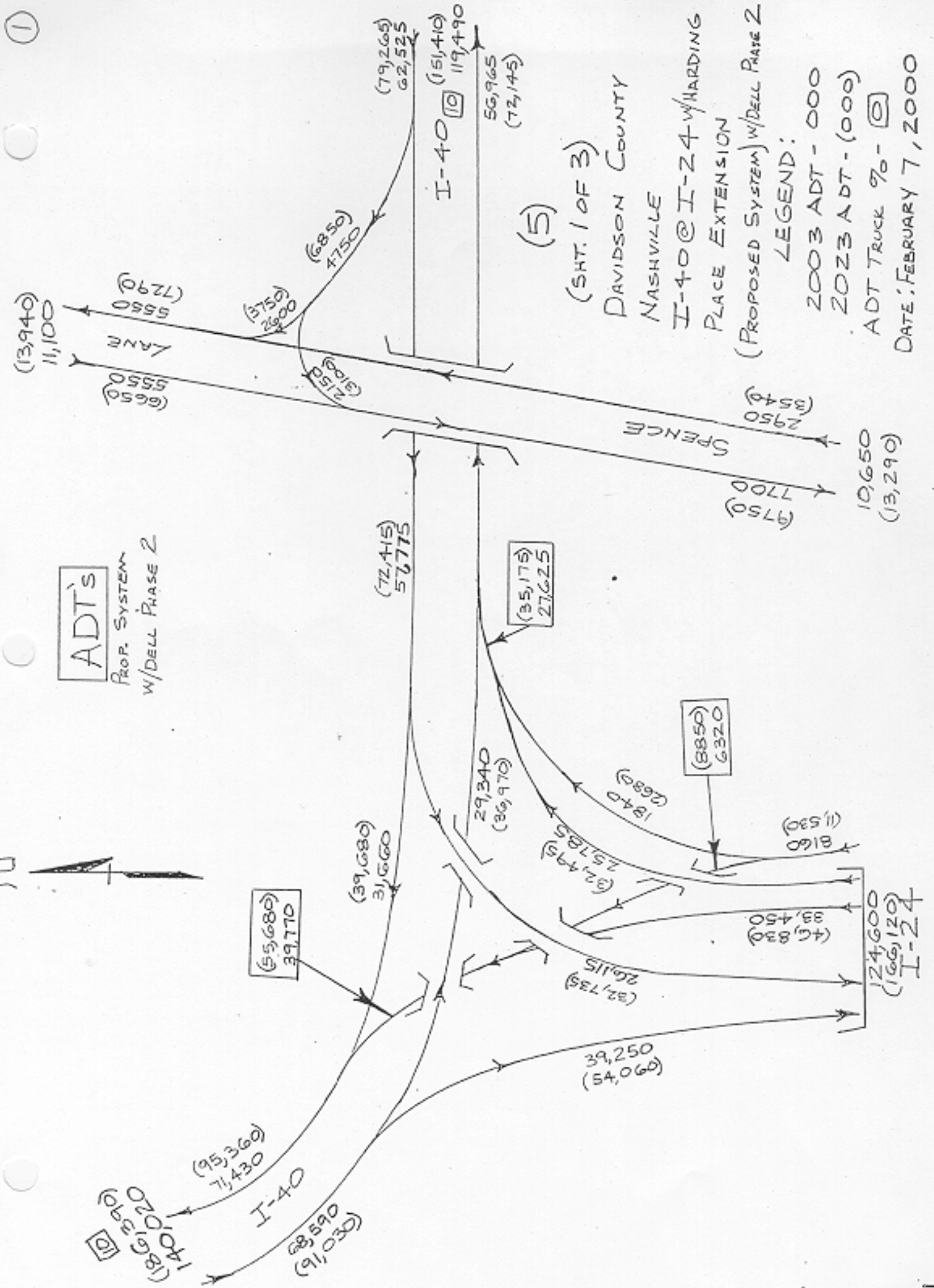

(5)
(SHT. 1 OF 3)

DAVIDSON COUNTY
NASHVILLE
I-40 @ I-24 W/HARDING
PLACE EXTENSION

(PROPOSED SYSTEM) w/DELL PHASE 2
LEGEND:

- 2003 ADT - 000
 - 2023 ADT - (000)
 - ADT TRUCK % - 0
- DATE: FEBRUARY 7, 2000

T.A.

①



1394

LANE
1329
1459
630
700
759
669

DHV's
PROP. SYSTEM
w/DELL PHASE 2

18,847

20,193
17,501

8886
10,356

I-40

7145
11,307

3863
4243

5023
6113

6618
8130

2443
5197

3516
3122

708
863

4702
6110

2755
3887

405
131

1312
994

4116
5250

16,961
16,497

I-24

16,729

786
884

7104
9014

I-40
16,222
14,710

5696
9118

15,466

(SHT. 1 OF 3)

DAVIDSON COUNTY
NASHVILLE

I-40 @ I-24 w/HARDING
PLACE EXTENSION.

(PROPOSED SYSTEM) w/DELL PHASE 2

2023 DHV

PM

AM

DATE: FEBRUARY 7, 2000

T.A.

APPENDIX B

LEVEL OF SERVICE: EXISTING AND PROPOSED

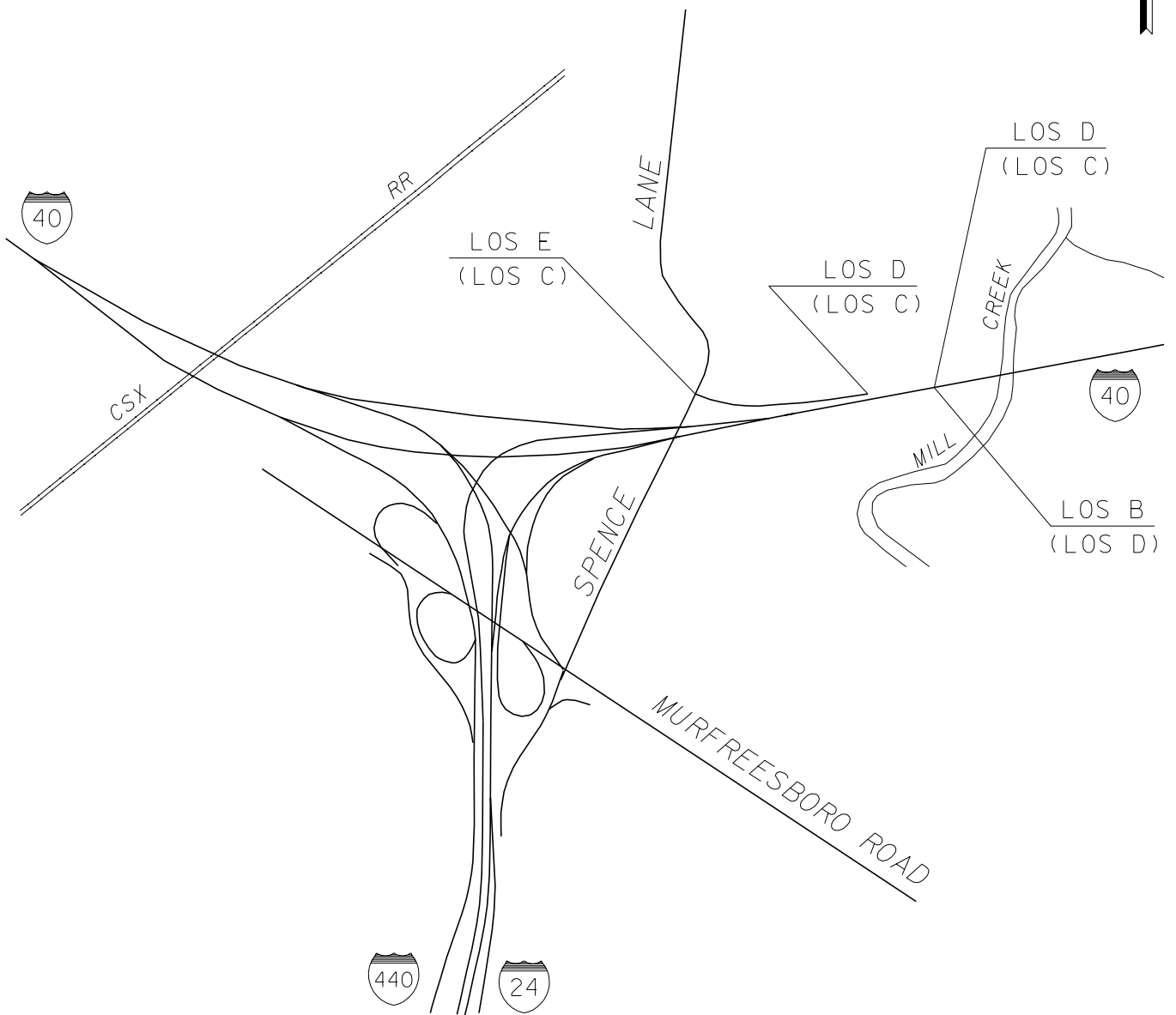

I-40 & SPENCE LANE.
INTERCHANGE MODIFICATION STUDY
NASHVILLE, DAVIDSON COUNTY, TENNESSEE
EXISTING 2003 CONDITIONS
AM - (PM)

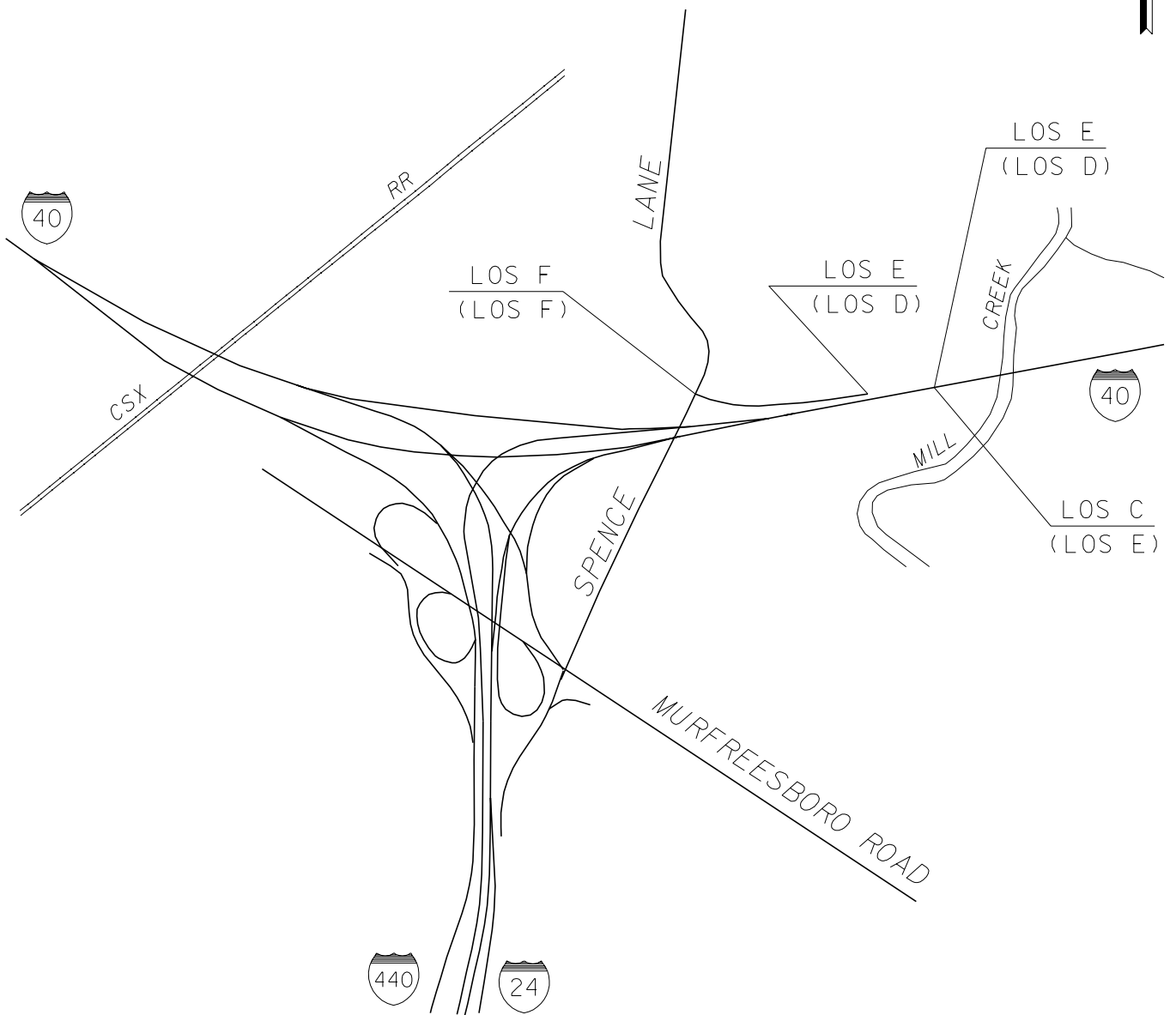

I-40 & SPENCE LANE.
INTERCHANGE MODIFICATION STUDY
NASHVILLE, DAVIDSON COUNTY, TENNESSEE
EXISTING 2023 CONDITIONS
AM - (PM)

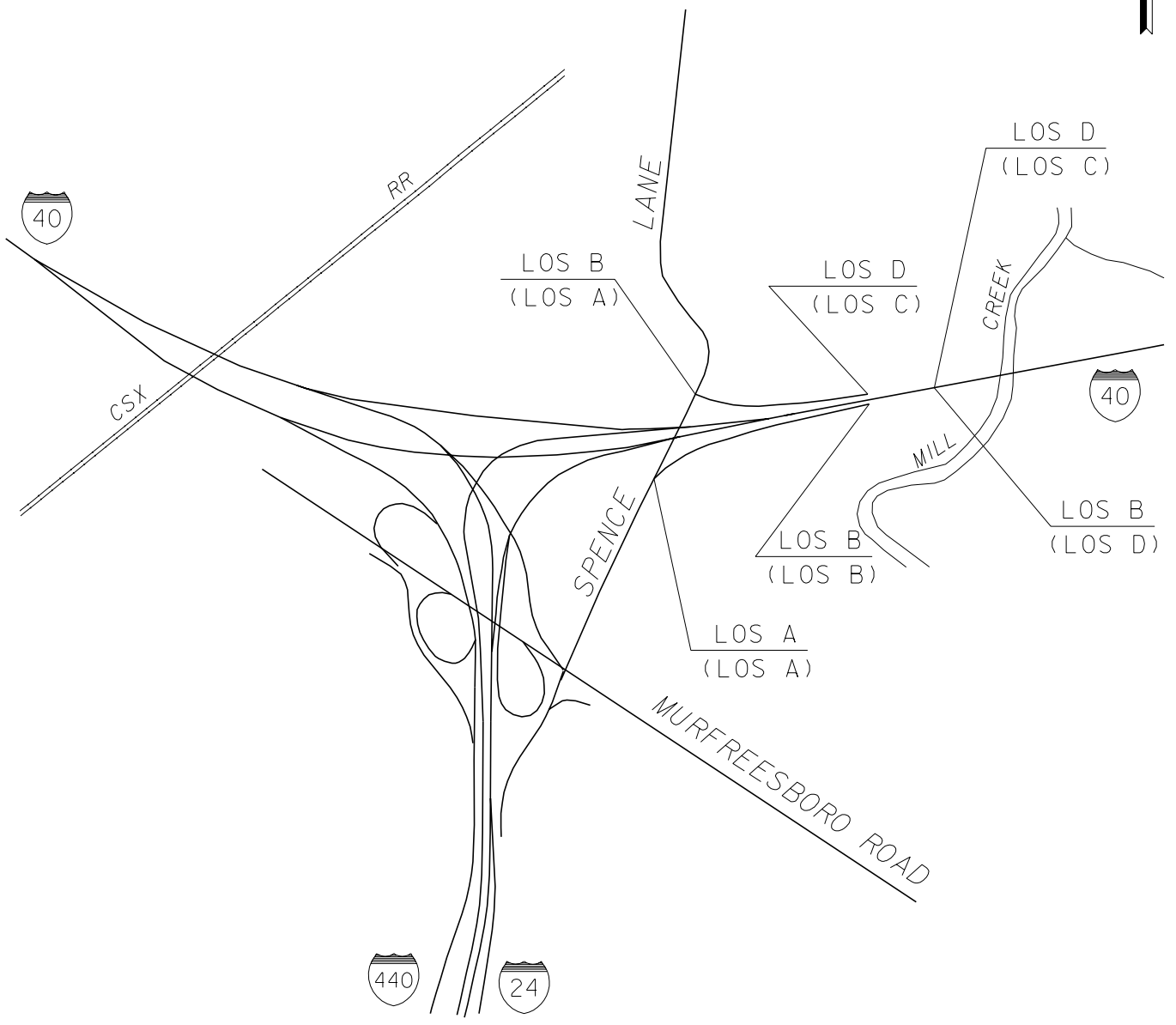

I-40 & SPENCE LANE.
INTERCHANGE MODIFICATION STUDY
NASHVILLE, DAVIDSON COUNTY, TENNESSEE
PROPOSED 2003 CONDITIONS
AM - (PM)

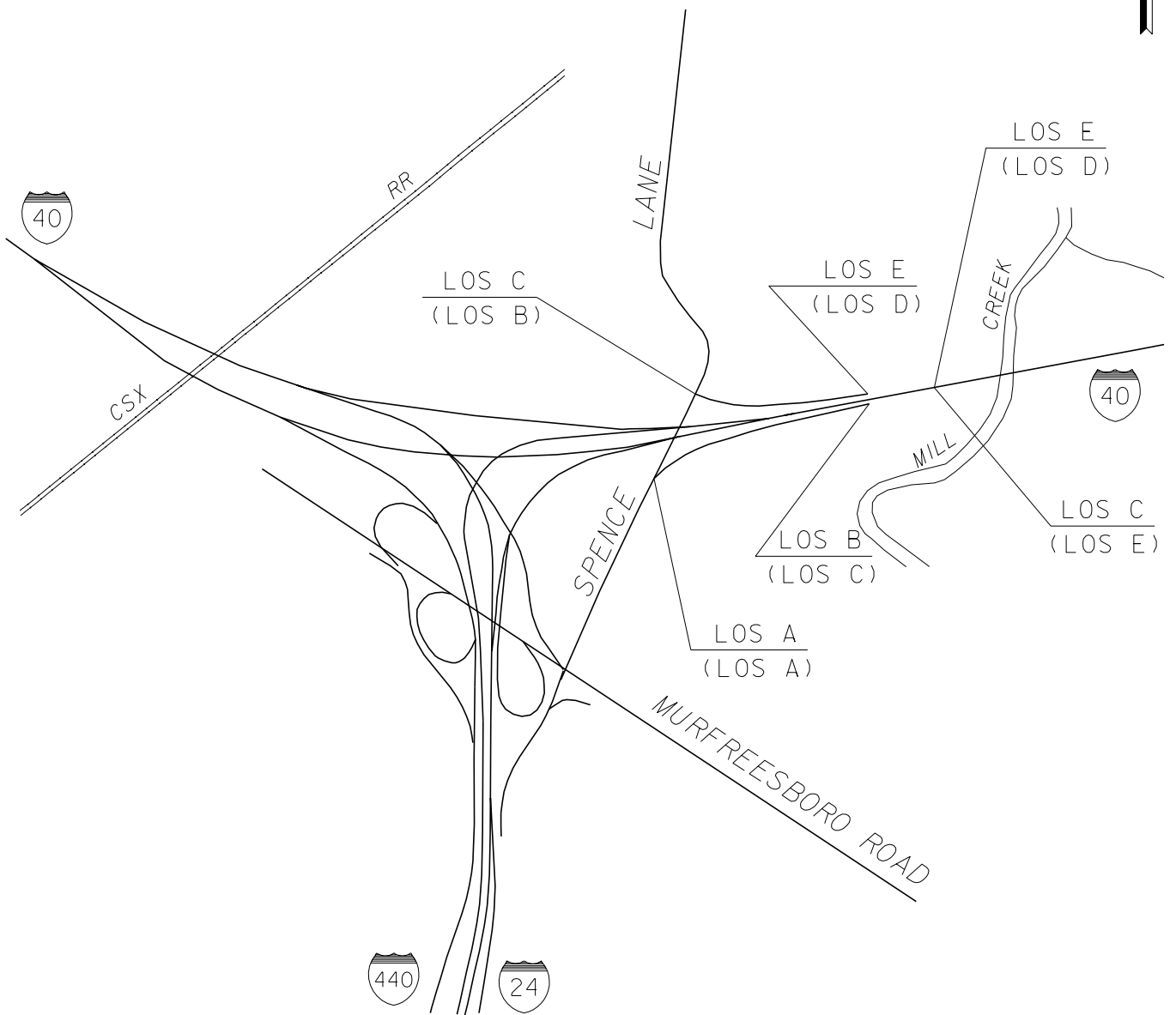

I-40 & SPENCE LANE.
INTERCHANGE MODIFICATION STUDY
NASHVILLE, DAVIDSON COUNTY, TENNESSEE
PROPOSED 2023 CONDITIONS
AM - (PM)

APPENDIX C

CAPACITY ANALYSIS: EXISTING CONDITIONS

**Please contact TDOT's Planning
Division for this information**

APPENDIX D

CAPACITY ANALYSIS: PROPOSED MODIFICATIONS

**Please contact TDOT's Planning
Division for this information**

APPENDIX E
COST ESTIMATES

COST DATA SHEET

PROJECT: I-40 & Spence Lane Interchange Modification Study
 LOCATION: Nashville, Davidson County, Tennessee
 LENGTH: 0.54 miles
 CROSS SECTION: N/A

RIGHT-OF-WAY

Land, Improvements & Damages	(# Acres	0.50)	\$522,000
Incidentals	(# Tracts	3)	\$15,000
Relocation Payments	(Residences	0)	\$0
	(Businesses	2)	\$40,000
	(Non-Profits	0)	
Total Right-Of-Way Cost			\$577,000

UTILITY RELOCATION

Reimbursable	\$0
Non-Reimbursable	\$345,000
Total Utility Adjustment Cost	
	\$345,000

CONSTRUCTION

Clear and Grubbing	\$1,000
Earthwork	\$310,000
Pavement Removal	\$59,000
Drainage (Erosion Control =	\$50,000)
Structures (Preserv'n/Demol'n =	\$0)
Railroad Crossing	\$0
Paving	\$740,000
Retaining Walls	\$456,000
Maintenance of Traffic	\$200,000
Topsoil	\$3,000
Seeding	\$2,000
Sodding	\$85,000
Signing	\$15,000
Signalization	\$0
Fence	\$29,000
Guardrail	\$6,000
Rip-rap or Slope Protection	\$2,000
Other Construction Items (8.5%)	\$188,000
Mobilization	\$126,000
10% Engineering and Contingencies	\$252,000
Total Construction Cost	
	\$2,773,000
Preliminary Engineering (10% of Constr.)	
	\$252,000

TOTAL ESTIMATED COST **\$3,947,000**

	Area (ac)	Cost/Acre	Total Cost
Clearing & Grubbing	0.5	\$2,000	\$1,000

Earthwork	Length (ft)	Factor	Total (yd ³)	Cost / yd ³	Total Cost
Spence Lane to I-40 (Entrance Ramp and Taper)	2,850	15.281	43,551		
Spence Lane Widening	2,060	9.34	19,240		
		6.22			
Total:			62,791	\$5.0	\$313,956

Pavement Removal	Length	Width	Total (sf)	Cost/sf	Total Cost
Murfreesboro Rd to I-40 E	918	16	14,688		
			14,688	\$4	\$58,752

Drainage	Misc. Pipes	Size(in)	Length(ft)	Cost	Total Cost		
		18	1600	\$20	\$32,000		
		24	900	\$26	\$23,400		
		30	600	\$31	\$18,600		
	Catchbasins	Number	26	\$2,500	\$65,000		
	Curb & Gutter	Length	4,120	Factor 0.07953	Total (CY) 328	\$150	\$49,150
	Side Walk	Length	4,120	Width 5	Total 20,600	\$2.5	\$51,500
	Headwalls	Number	9	\$1,000	\$9,000	\$248,650	

Erosion Control **\$50,000**

Structures	Bridges	Width	Length	Area	Cost/sf	Total Cost
				0	\$80	\$0
				0	\$80	\$0
				0	\$25	\$0
	Replace Rail:	0	ft		\$100.00 per ft.	\$0
	Demolition	Width	Length	Area	Cost/sf	Total Cost
		0	0	0	\$10	\$0
		0	0	0	\$10	\$0
		0	0	0	\$10	\$0
		0	0	0	\$10	\$0
		Total Demolition Cost:				\$0
		Total Structure Cost:				\$0

Fence	Length	Cost	Total Cost
	2,945	\$10	\$29,450

Paving	Cost	Length	Total Cost
Spence Lane 5 Lane with C&G	\$205	2,060	\$422,300
Spence Lane 5 Lane to 2 Lane Trans.	\$75	550	\$41,250
1 Lane Entrance Ramp	\$79	2,850	\$225,150
I-24 to I-40 East	\$60	850	\$51,000
			\$0
Total Paving Cost:			\$739,700

Retaining Walls

	Height	Length	Area	Cost/sf	
Retaining Wall	20	380	7600	35	\$266,000
Retaining Wall	5	1,205	6025	20	\$120,500
Concrete Barrier Wall	2	300	600	50	\$30,000
Retaining Wall (Ramada Inn)	5	250	1250	20	\$25,000
Retaining Wall (Ramada Inn)	3	240	720	20	\$14,400
Total Retaining Walls:					\$455,900

Maintenance of Traffic

Topsoil	Length	Factor	x 2	Total	Cost per	
	2,000	0.283	2	1,132	\$3.00	\$3,396

Seeding	Length	Factor	x 2	Total	Cost per	
	2,000	0.030	2	120	\$16.00	\$1,920

Sodding	Length	Factor	x 2	Total	Cost per	
	5,220	2.711	2	28,303	\$3.00	\$84,909

Total Sod \$84,909

Signing

Signalization	Number	Cost per	
New Signals (2)	2	\$50,000	\$100,000
Modify Existing Signal (1)	1	\$35,000	\$35,000

Guardrail

Length of rail	Number of Terminals	Cost	Total Cost
350 ft	2	\$1,000	\$2,000
		\$10	\$3,500
Total Guardrail:			\$5,500

Rip-Rap

Right-of-Way

	Cost/acre	Cost	Total Cost
Total acreage	0.5 acres	\$100,000	\$50,000
Slope Easmt.	0.0 acres	\$25,000	\$0
Const. Easmt.	0.0 acres	\$25,000	\$0
Total		\$50,000	\$71,500
No. of Tracts	3	Cost/tract	\$5,000
Relocate (2) Businesses	2	@	\$20,000
Acquire (2) Business			\$450,000
Total Right-of-Way Cost:			\$576,500

Utilities

Reimbursable

	Length (ft)	Cost/ft	Total Cost
12" Steel Gas	0	\$84	\$0
16" Water	0	\$45	\$0

Total Reimbursable \$0

Non-Reimbursable

	Length (ft)	Cost/ft	Total Cost
6" Gas	2,610	\$25	\$65,250
16" Water	2,610	\$45	\$117,450
8" Sewer	2,610	\$22	\$57,420

	Cost/each	Total Cost
Electric + Tel. 26 Poles	\$3,600	\$93,600
Telephone 0 Poles	\$2,600	\$0
Manholes 9	\$1,200	\$10,800

Total Non-Reimbursable \$344,520
Total Utility Cost: \$344,520

APPENDIX F
FUNCTIONAL PLANS

Index Of Sheets

SHEET NO.	DESCRIPTION
1	TITLE SHEET
2,2A	TYPICAL SECTIONS
3-10	PROPOSED LAYOUT SHEETS

STATE OF TENNESSEE DEPARTMENT OF TRANSPORTATION BUREAU OF PLANNING AND DEVELOPMENT

DAVIDSON COUNTY

I-40 AND SPENCE LANE INTERCHANGE MODIFICATION STUDY

STATE HIGHWAY NO. F.A.H.S. NO.

TENN.	YEAR	SHEET NO.
	2002	1
FED. AID PROJ. NO.		
STATE PROJ. NO.		

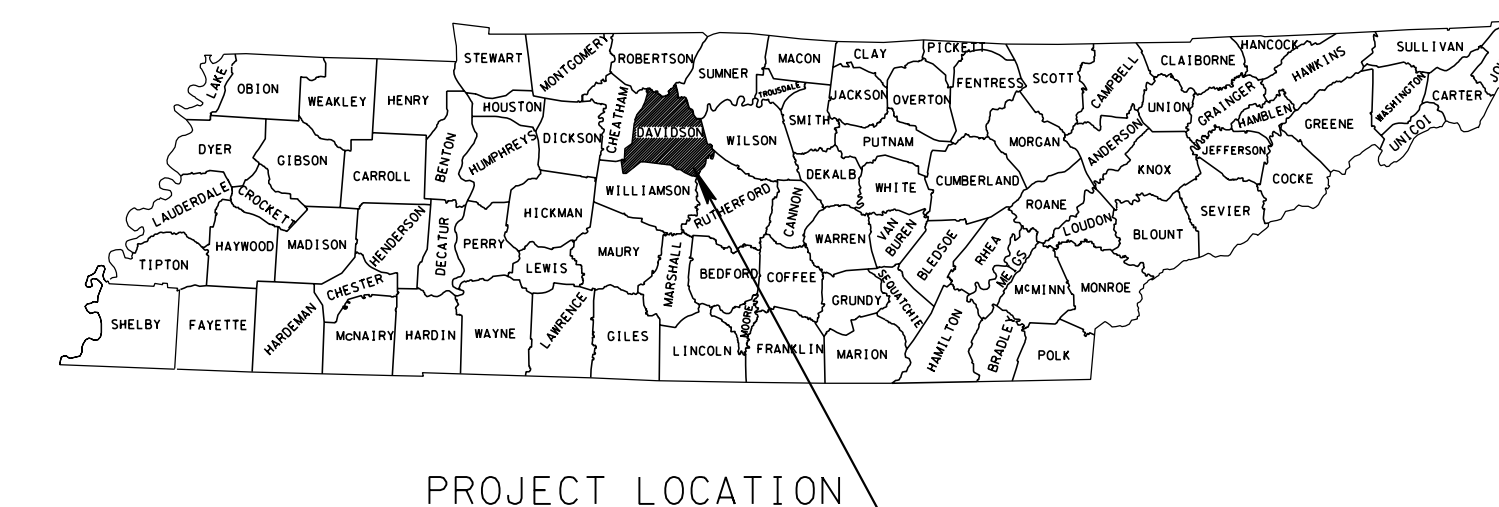

PROJECT LOCATION

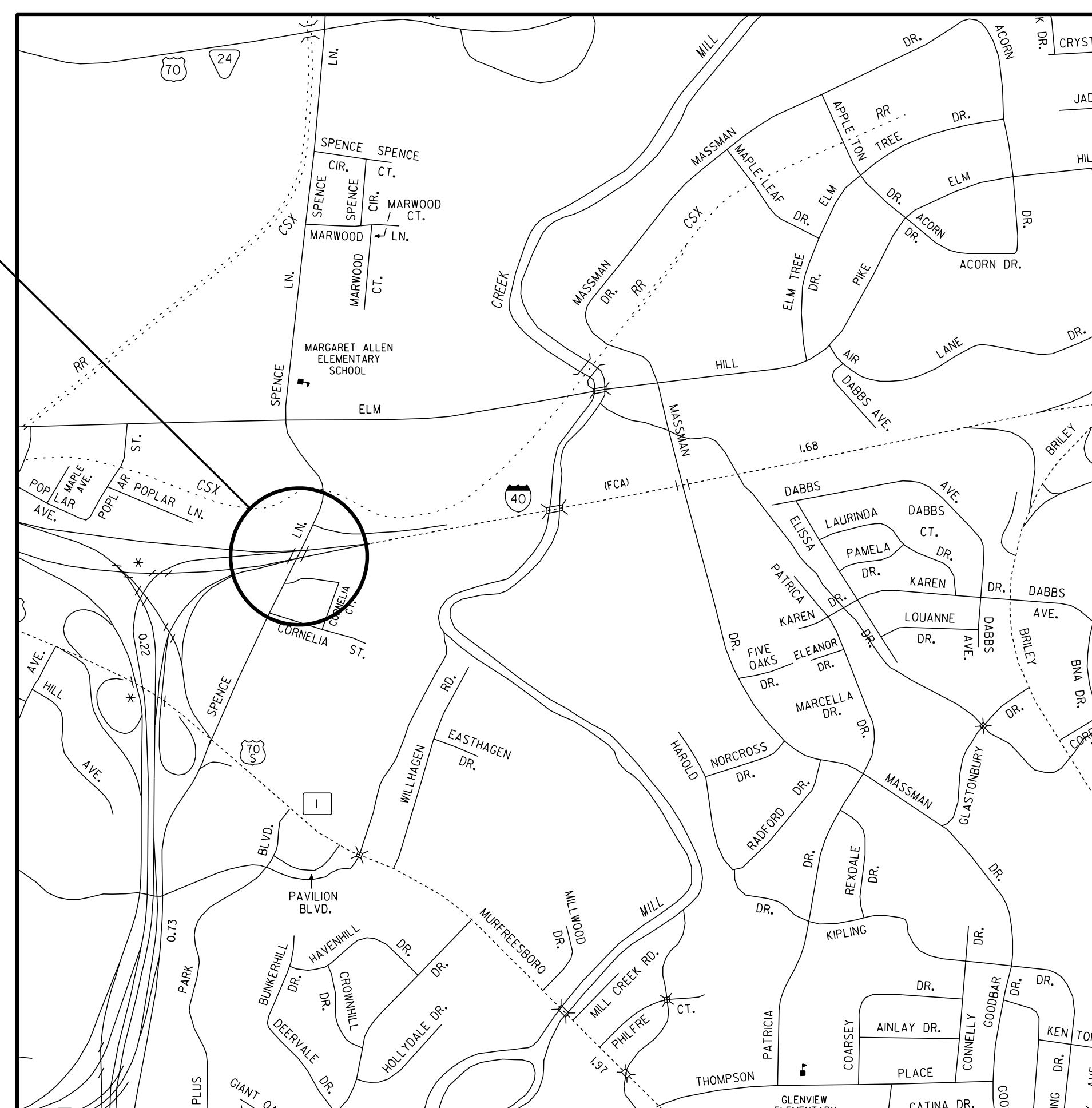

SCALE: 1" = 1000'

SPECIAL NOTES

PROPOSALS MAY BE REJECTED BY THE COMMISSIONER IF ANY OF THE UNIT PRICES CONTAINED THEREIN ARE OBVIOUSLY UNBALANCED, EITHER EXCESSIVE OR BELOW THE REASONABLE COST ANALYSIS VALUE.

THIS PROJECT TO BE CONSTRUCTED UNDER THE STANDARD SPECIFICATIONS OF THE TENNESSEE DEPARTMENT OF TRANSPORTATION DATED MARCH 1, 1995 AND ADDITIONAL SPECIFICATIONS AND SPECIAL PROVISIONS CONTAINED IN THE PLANS AND IN THE PROPOSAL CONTRACT

DESIGNED BY THOMAS & MILLER, LLC

DESIGNER THOMAS M. CLINARD, P.E. CHECKED BY _____

P.E. NO. _____

APPROVED: _____
DIRECTOR, DESIGN DIVISION

DATE: _____

APPROVED: _____
COMMISSIONER

TRAFFIC DATA	
ADT (2003)	119,490
ADT (2023)	151,410
DHV (2023)	15,466
D	55 - 45
T (ADT)	10 %
T (DHV)	8 %
V	60 MPH

U.S. DEPARTMENT OF TRANSPORTATION
FEDERAL HIGHWAY ADMINISTRATION

APPROVED: _____
DIVISION ADMINISTRATOR DATE

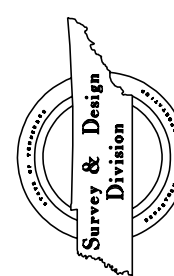

TYPE	YEAR	PROJECT NO.	SHEET NO.
A.P.R.	2002		2

TENNESSEE D.O.T.
DESIGN DIVISION
FILE NO.

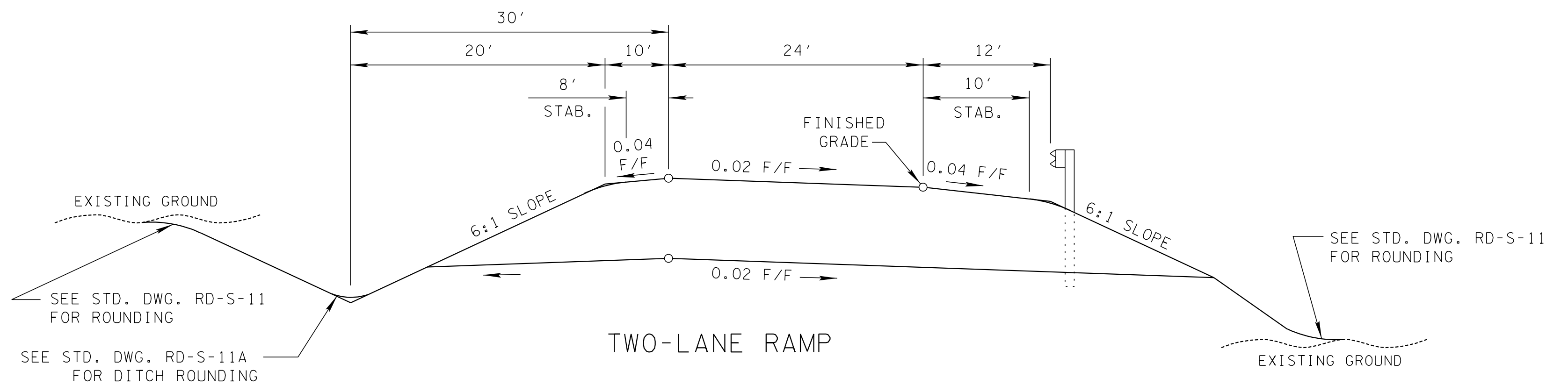
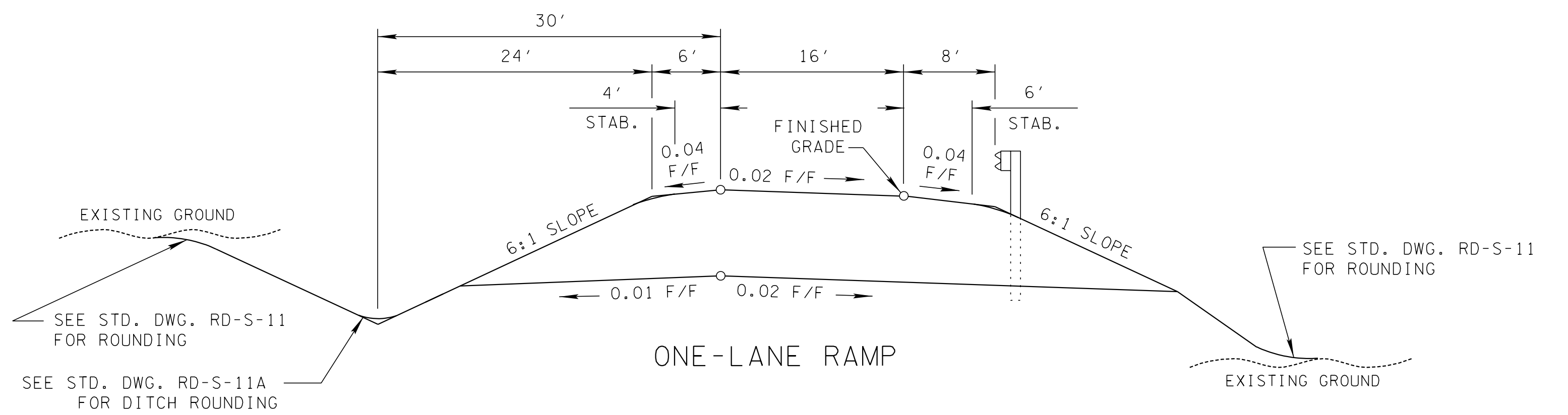
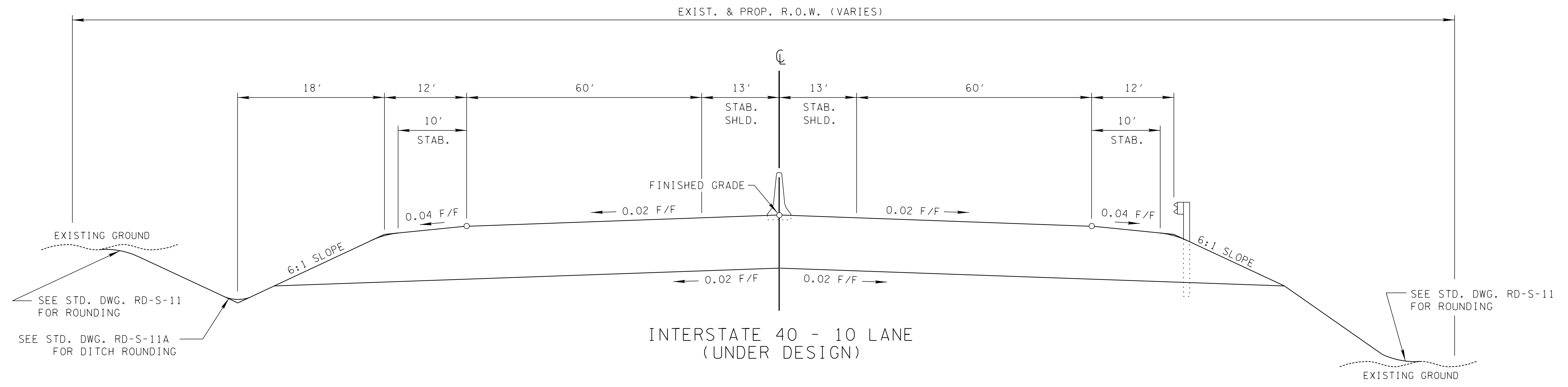

STATE OF TENNESSEE
DEPARTMENT OF TRANSPORTATION
BUREAU OF PLANNING & DEVELOPMENT

TYPICAL
SECTIONS

TENNESSEE D.O.T.
DESIGN DIVISION

FILE NO.



TYPE	YEAR	PROJECT NO.	SHEET NO.
A.P.R.	2002		3



STATE OF TENNESSEE
DEPARTMENT OF TRANSPORTATION
BUREAU OF PLANNING & DEVELOPMENT

**I-40 & SPENCE
LANE INTERCHANGE
MODIFICATION STUDY**

NASHVILLE, TN
DAVIDSON CO.

TENNESSEE D.O.T.
DESIGN DIVISION

FILE NO.

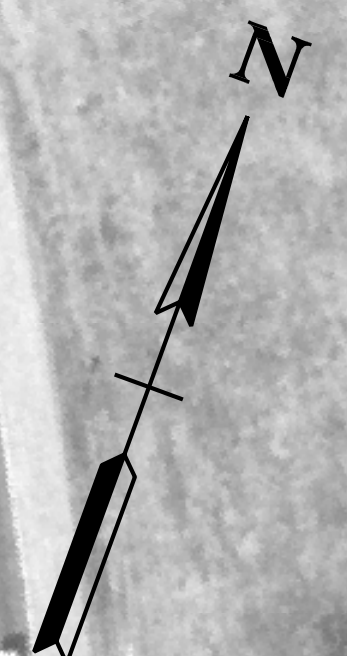

TYPE	YEAR	PROJECT NO.	SHEET NO.
A.P.R.	2002		4



STATE OF TENNESSEE
DEPARTMENT OF TRANSPORTATION
BUREAU OF PLANNING & DEVELOPMENT

**I-40 & SPENCE
LANE INTERCHANGE
MODIFICATION STUDY**

NASHVILLE, TN
DAVIDSON CO.

TYPE	YEAR	PROJECT NO.	SHEET NO.
A.P.R.	2002		5

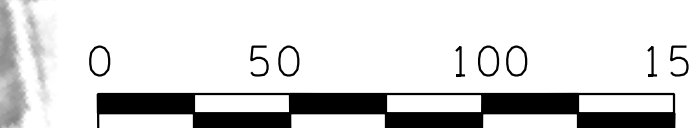
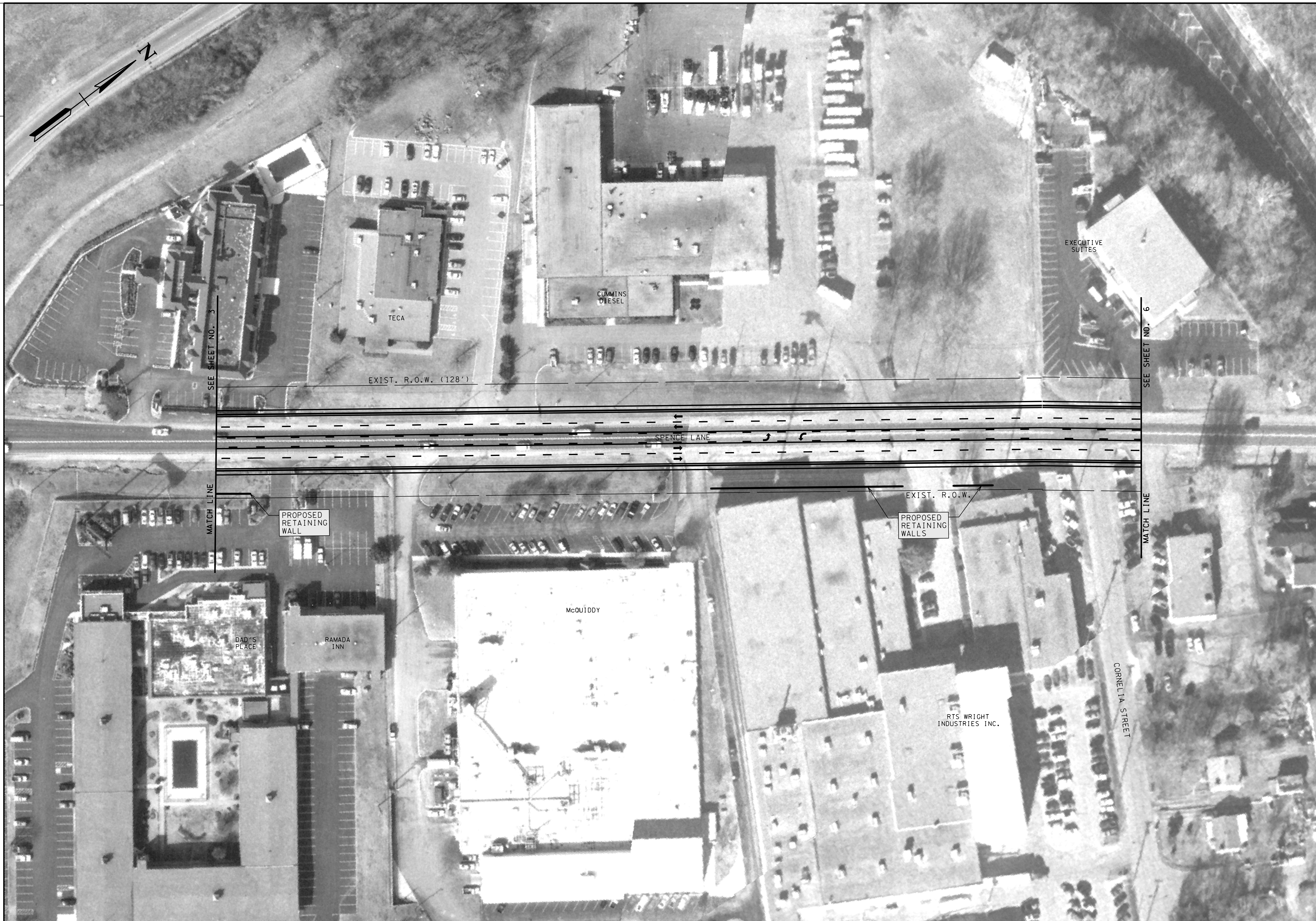

STATE OF TENNESSEE
DEPARTMENT OF TRANSPORTATION
BUREAU OF PLANNING & DEVELOPMENT

**I-40 & SPENCE
LANE INTERCHANGE
MODIFICATION STUDY**

NASHVILLE, TN
DAVIDSON CO.

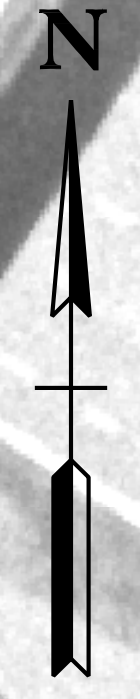

TYPE	YEAR	PROJECT NO.	SHEET NO.
A.P.R.	2002		6



STATE OF TENNESSEE
DEPARTMENT OF TRANSPORTATION
BUREAU OF PLANNING & DEVELOPMENT

**I-40 & SPENCE
LANE INTERCHANGE
MODIFICATION STUDY**

NASHVILLE, TN
DAVIDSON CO.

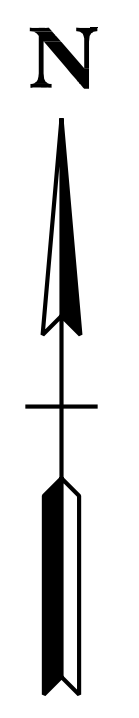

TYPE	YEAR	PROJECT NO.	SHEET NO.
A.P.R.	2002		7



STATE OF TENNESSEE
DEPARTMENT OF TRANSPORTATION
BUREAU OF PLANNING & DEVELOPMENT

**I-40 & SPENCE
LANE INTERCHANGE
MODIFICATION STUDY**

NASHVILLE, TN
DAVIDSON CO.



TYPE	YEAR	PROJECT NO.	SHEET NO.
A.P.R.	2002		8

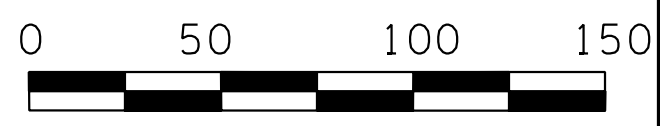
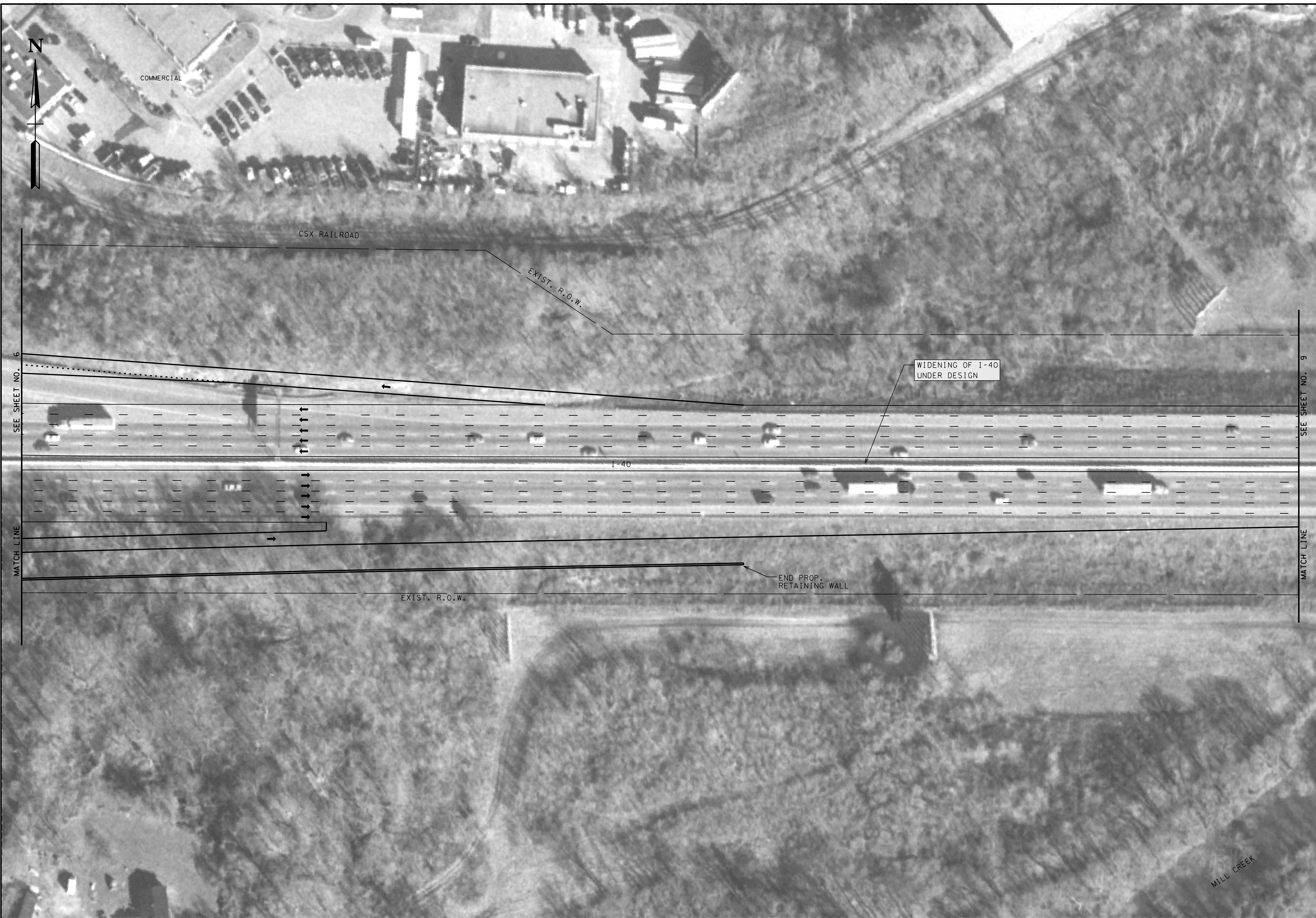

STATE OF TENNESSEE
DEPARTMENT OF TRANSPORTATION
BUREAU OF PLANNING & DEVELOPMENT

**I-40 & SPENCE
LANE INTERCHANGE
MODIFICATION STUDY**

NASHVILLE, TN
DAVIDSON CO.

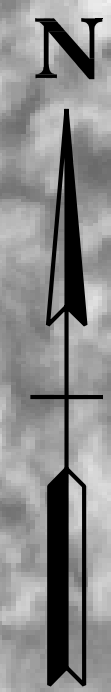

TYPE	YEAR	PROJECT NO.	SHEET NO.
A.P.R.	2002		9



STATE OF TENNESSEE
 DEPARTMENT OF TRANSPORTATION
 BUREAU OF PLANNING & DEVELOPMENT

**I-40 & SPENCE
 LANE INTERCHANGE
 MODIFICATION STUDY**

NASHVILLE, TN
 DAVIDSON CO.



TYPE	YEAR	PROJECT NO.	SHEET NO.
A.P.R.	2002		10



STATE OF TENNESSEE
DEPARTMENT OF TRANSPORTATION
BUREAU OF PLANNING & DEVELOPMENT

**I-40 & SPENCE
LANE INTERCHANGE
MODIFICATION STUDY**

NASHVILLE, TN
DAVIDSON CO.

APPENDIX G
BACKGROUND INFORMATION

**Please contact TDOT's Planning
Division for this information**