

**RDWP/RAWP for the Groundwater Field Demonstration at the
Environmental Management Disposal Facility,
Oak Ridge, Tennessee**



This document is approved for public
release per review by:

Dave Lannom

UCOR Classification &
Information Control Office

9/11/2023

Date

DOE/OR/01-2948&D2

**RDWP/RAWP for the Groundwater Field Demonstration at the
Environmental Management Disposal Facility,
Oak Ridge, Tennessee**

Date Issued—September 2023

Prepared for the
U.S. Department of Energy
Oak Ridge Office of Environmental Management

United Cleanup Oak Ridge LLC
under contract 89303322DEM000067

This page intentionally left blank.

CONTENTS

FIGURES	v
TABLES	v
ACRONYMS	vii
EXECUTIVE SUMMARY	ix
1. INTRODUCTION AND PURPOSE.....	1
2. PROJECT ORGANIZATION AND SCHEDULE	3
2.1 PROJECT ORGANIZATION.....	3
2.1.1 OREM.....	3
2.1.2 Regulators.....	4
2.1.3 UCOR	4
2.2 PROJECT SCHEDULE	4
3. SITE DESCRIPTION.....	5
3.1 GEOLOGY.....	5
3.2 GROUNDWATER.....	5
3.3 SURFACE WATER.....	8
3.4 ECOLOGICAL RESOURCES	9
3.5 CULTURAL RESOURCES	14
4. PROJECT DESCRIPTION	15
4.1 OVERVIEW AND DESIGN APPROACH.....	15
4.2 KEY GWFD-RELATED FEATURES OF THE LANDFILL DESIGN	16
4.3 GWFD DESIGN	17
4.4 GWFD AREA	17
5. APPLICABLE OR RELEVANT AND APPROPRIATE REQUIREMENTS	19
6. GWFD IMPLEMENTATION AND APPROACH.....	21
6.1 SITE PREPARATION	21
6.2 UPGRADIENT STORMFLOW INTERCEPTOR CHANNEL	21
6.3 TEMPORARY COVER SYSTEM.....	25
6.3.1 Design Basis and Requirements	25
6.3.2 Site Clearing and Grubbing	27
6.3.3 Subgrade preparation	27
6.3.4 Cover System Anchor Trenches	28
6.3.5 Temporary Cover System	28
6.3.6 Sand Infill	31
6.3.7 Maintenance of the Temporary Cover System	31
6.4 BORROW AREA 7B DEVELOPMENT	31
6.5 SEDIMENT AND EROSION CONTROL.....	32
7. WASTE MANAGEMENT	35

8.	SAMPLING AND ANALYSIS PLAN.....	37
8.1	OBJECTIVES	37
8.2	PIEZOMETERS.....	37
8.2.1	New Piezometers to be Installed.....	41
8.2.2	Piezometer, Seismic Boreholes, and Well to be Abandoned.....	42
8.2.3	GWFD Monitoring Summary.....	42
8.3	PRECIPITATION MONITORING	45
8.4	INTERPRETATION OF MONITORING RESULTS	45
8.5	PERFORMANCE/ACCEPTANCE CRITERIA.....	46
8.6	REPORTING OF MONITORING RESULTS	46
9.	SCHEDULE	47
10.	REFERENCES.....	49
	APPENDIX A. SENSITIVE RESOURCES.....	A-1
	APPENDIX B. GWFD APPLICABLE OR RELEVANT AND APPROPRIATE REQUIREMENTS ..	B-1
	APPENDIX C. KEY GWFD DESIGN DRAWINGS AND SPECIFICATIONS.....	C-1

FIGURES

Fig. 1. EMDF GWFD Project organization.....	3
Fig. 2. EMDF area existing piezometers and other features.....	6
Fig. 3. Seasonal change and response to precipitation in selected shallow piezometers.....	7
Fig. 4. Macropores examples in the EMDF area.....	8
Fig. 5. EMDF natural resource evaluation and EMDF activities.....	11
Fig. 6. Four-toed salamander and tubercled rein orchid locations—EMDF area.....	13
Fig. 7. GWFD Project layout.....	18
Fig. 8. EMDF GWFD approach to natural resource ARARs.....	19
Fig. 9. Upgradient stormflow interceptor channel.....	23
Fig. 10. Design details for the upgradient stormflow interceptor channel.....	24
Fig. 11. GWFD south-north cross-section through temporary cover.....	26
Fig. 12. Design details for the temporary cover system.....	29
Fig. 13. EMDF east-west profile.....	38
Fig. 14. Changes to piezometer network.....	40
Fig. 15. GWFD monitoring locations.....	43
Fig. 16. GWFD key activities.....	48

TABLES

Table 1. Key activities and dates for GWFD scope.....	4
Table 2. HDPE geomembrane properties.....	30
Table 3. Engineered turf properties.....	31
Table 4. Summary of wastes generated by GWFD activities.....	35
Table 5. EMDF average seasonal high and low groundwater elevations—shallow piezometers/GWFD area.....	39
Table 6. GWFD additional piezometer construction information.....	41
Table 7. GWFD piezometers to be abandoned.....	42
Table 8. GWFD monitoring piezometers summary.....	44

This page intentionally left blank.

ACRONYMS

ARAR	applicable or relevant and appropriate requirement
BMP	best management practice
CO	Contracting Officer
CBCV	Central Bear Creek Valley
CERCLA	Comprehensive Environmental Response, Compensation, and Liability Act of 1980
D	Drainage
dbh	diameter at breast height
DOE	U.S. Department of Energy
EMDF	Environmental Management Disposal Facility
EMWMF	Environmental Management Waste Management Facility
ESP	Early Site Preparation
EPA	U.S. Environmental Protection Agency
FFA	Federal Facility Agreement
FY	fiscal year
GWFD	groundwater field demonstration
HDPE	high-density polyethylene
NT	North Tributary
OREM	Oak Ridge Office of Environmental Management
ORNL	Oak Ridge National Laboratory
ORR	Oak Ridge Reservation
ORRL	Oak Ridge Reservation Landfill
QA	quality assurance
QC	quality control
RAO	remedial action objective
RCRA	Resource Conservation and Recovery Act of 1976
RDR	Remedial Design Report
RDWP/RAWP	Remedial Design Work Plan/Remedial Action Work Plan
ROD	Record of Decision
TDEC	Tennessee Department of Environment and Conservation
TM	Technical Memorandum
UCOR	United Cleanup Oak Ridge LLC
USF&WS	U.S. Fish & Wildlife Service
W	West
Y-12	Y-12 National Security Complex

This page intentionally left blank.

EXECUTIVE SUMMARY

The *Record of Decision for Comprehensive Environmental Response, Compensation, and Liability Act Oak Ridge Reservation Waste Disposal at the Environmental Management Disposal Facility, Oak Ridge, Tennessee* (Environmental Management Disposal Facility [EMDF] Record of Decision [ROD]) (DOE/OR/01-2794&D2/R2) presents the selected remedy of construction and operation of an onsite waste disposal site for Oak Ridge Reservation (ORR) Comprehensive Environmental Response, Compensation, and Liability Act of 1980 (CERCLA) waste. (Note that EMDF is also referred to as the Onsite Waste Disposal Site.) EMDF supports the U.S. Department of Energy Oak Ridge Office of Environmental Management's mission to decommission and demolish facilities and conduct remedial actions under CERCLA on the ORR in Oak Ridge, Tennessee. This effort requires an estimated 2.2 million cy of additional landfill disposal capacity for the disposal of wastes from CERCLA cleanup actions. As such, EMDF will be constructed in Central Bear Creek Valley.

This Remedial Design Work Plan/Remedial Action Plan (RDWP/RAWP) was prepared to present the plan for the groundwater field demonstration (GWFD) as described in the EMDF ROD. This RDWP/RAWP describes the GWFD design and implementation approach. The GWFD is not part of the remedy, but will inform the final landfill design.

The GWFD is designed to approximate the elimination of recharge to groundwater from construction of the EMDF landfill in the knoll area. The significant elements of the GWFD specified in the EMDF ROD are:

- Determination of the areal extent of the study area, sized to sufficiently mimic anticipated, constructed landfill cells.
- Use of existing piezometers to collect groundwater elevation data for evaluation to determine the seasonal high water table.
- Installation of additional piezometers as needed in the study area, to provide sufficient groundwater elevation data so that interpretation of data is minimal.
- Clearing of the study area, and excavation as needed, to provide for constructability, to remove material to help protect the temporary liner, and to ensure worker safety.
- Installation of a temporary liner system over the study area, similar to the enhanced cover at the existing Environmental Management Waste Management Facility, to shed rainwater and reduce infiltration into the ground.
- Excavation, as necessary, to ensure stormflow drains from the demonstration area toward the tributaries; an upgradient trench will be necessary to facilitate movement of water around the study area.
- Engineered features may be necessary to improve construction conditions in the study area.
- Evaluation of the seasonal high water table of the uppermost aquifer, defined as the potentiometric surface based on the 80th percentile of water levels in the month with the maximum monthly median during the evaluation period (this may be thought of as the wettest month, where *wettest* refers to highest groundwater level and not necessarily the month with the most precipitation).
- Duration will include two wet seasons; after the first wet season, final design will begin based on the available data, and data collection will continue in the second wet season to refine the design, if needed.

- Adjustment to the evaluation results. If deemed necessary due to a demonstration period that is not representative of historical rainfall (significantly wetter or drier), an adjustment may be warranted. The determination of the method used to calculate the adjustments will be completed by a Federal Facility Agreement (FFA) triparty technical team. The adjustment process will include comparison of rainfall amount, duration, and frequency to historical measurements, and responses measured in surrounding piezometers to historical groundwater information. The representative criteria and adjustment method will be determined by the FFA triparty technical team.
- Evaluations will use linear interpolation between piezometers.

Where effective in supporting the GWFD goals, design elements of the landfill are incorporated into the GWFD, such as the upgradient stormflow interceptor channel (6th bullet above) and sediment basins that will be used for sediment control for the GWFD and the future landfill disposal cells. These basins will collect stormwater and surface water runoff from the GWFD and future landfill disposal cells.

A detailed natural resource evaluation and wetland delineation study was performed, and the results are included.

A Stormwater Management Requirements document will be implemented to protect surface water during implementation of this scope.

1. INTRODUCTION AND PURPOSE

This Remedial Design Work Plan/Remedial Action Plan (RDWP/RAWP) was prepared to present the plan for the groundwater field demonstration (GWFD) as described in the *Record of Decision for Comprehensive Environmental Response, Compensation, and Liability Act Oak Ridge Reservation Waste Disposal at the Environmental Management Disposal Facility, Oak Ridge, Tennessee* (ROD) (DOE/OR/01-2794&D2/R2). This RDWP/RAWP describes the GWFD design and implementation approach. (Note that the Environmental Management Disposal Facility [EMDF] is also referred to as the Onsite Waste Disposal Site.) EMDF supports the U.S. Department of Energy (DOE) Oak Ridge Office of Environmental Management's (OREM's) mission to decommission and demolish facilities and conduct remedial actions under the Comprehensive Environmental Response, Compensation, and Liability Act of 1980 (CERCLA) on the Oak Ridge Reservation (ORR) in Oak Ridge, Tennessee. This effort requires an estimated 2.2 million cy of additional landfill disposal capacity for the disposal of wastes from CERCLA cleanup actions. As such, EMDF will be constructed in the Central Bear Creek Valley (CBCV).

This RDWP/RAWP was prepared to present the plan for the GWFD, as described in the EMDF ROD. This RDWP/RAWP describes the GWFD design and implementation approach. The GWFD is not part of the remedy, but will inform the final landfill design.

The landfill design will meet the remedial action objective (RAO) to maintain a 15-ft separation between the bottom of emplaced wastes and the seasonal high water table of the uppermost unconfined aquifer, which includes 5 ft of liner system and 10 ft of geologic buffer, consistent with TDEC 0400-11-01-.04(4)(a)(2), *Solid Waste Processing and Disposal*, "Specific Requirements for Class I, II, III, and IV Disposal Facilities."

The objective of the GWFD is to determine the seasonal high post-construction groundwater table that will control the final design elevation of the geologic buffer in the knoll area, where the seasonal high groundwater elevations sometimes exceed the preliminary design base. The GWFD will be accomplished by placing a temporary, low-permeability cover system (the technical equivalent to the liner system required by the ROD) over the EMDF knoll area, then directly measuring seasonal high (wet season) groundwater elevations to estimate future, post-construction groundwater elevations. These seasonal high groundwater elevation measurements will be used to establish the design base of the geologic buffer.

In accordance with the ROD, results of the field study will be incorporated into the Remedial Design Report (RDR) for the landfill design; the RDR is a primary document that requires approval by the Federal Facility Agreement (FFA) parties before landfill construction.

The significant elements of the GWFD specified in the EMDF ROD are:

- Determination of the areal extent of the study area, sized to sufficiently mimic anticipated, constructed landfill cells.
- Use of existing piezometers to collect groundwater elevation data for evaluation to determine the seasonal high water table.
- Installation of additional piezometers as needed in the study area, to provide sufficient groundwater elevation data so that interpretation of data is minimal.
- Clearing of the study area, and excavation as needed, to provide for constructability, to remove material to help protect the temporary liner, and to ensure worker safety.

- Installation of a temporary liner system over the study area, similar to the enhanced cover at the existing Environmental Management Waste Management Facility (EMWMF), to shed rainwater and reduce infiltration into the ground.
- Excavation, as necessary, to ensure stormflow drains from the demonstration area toward the tributaries; an upgradient trench will be necessary to facilitate movement of water around the study area.
- Engineered features may be necessary to improve construction conditions in the study area.
- Evaluation of the seasonal high water table of the uppermost aquifer, defined as the potentiometric surface based on the 80th percentile of water levels in the month with the maximum monthly median during the evaluation period (this may be thought of as the wettest month, where *wettest* refers to highest groundwater level and not necessarily the month with the most precipitation).
- Duration will include two wet seasons; after the first wet season, final design will begin, based on the available data, and data collection will continue in the second wet season to refine the design, if needed.
- Adjustment to the evaluation results. If deemed necessary due to a demonstration period that is not representative of historical rainfall (significantly wetter or drier), an adjustment may be warranted. The determination of the method used to calculate the adjustments will be completed by an FFA triparty technical team. The adjustment process will include comparison of rainfall amount, duration, and frequency to historical measurements, and responses measured in surrounding piezometers to historical groundwater information. The representative criteria and adjustment method will be determined by the FFA triparty technical team.
- Evaluations will use linear interpolation between piezometers.

The purpose of this RDWP/RAWP is to describe the GWFD components to be designed and to describe how the temporary cover system and other features required for the GWFD will be installed. As described in the ROD, the design of the GWFD will be included in the RDR for the landfill. The results of the GWFD will be presented in two Technical Memoranda, one for results from each wet season monitored during the GWFD. The results and Memoranda will be used to support development of the EMDF RDR.

Because fill material will be necessary to complete the GWFD, this RDWP/RAWP also includes development of the Site 7B Borrow Area, located adjacent to the GWFD site, as a potential fill source area.

2. PROJECT ORGANIZATION AND SCHEDULE

2.1 PROJECT ORGANIZATION

The organizational structure for this project is presented in Fig. 1.

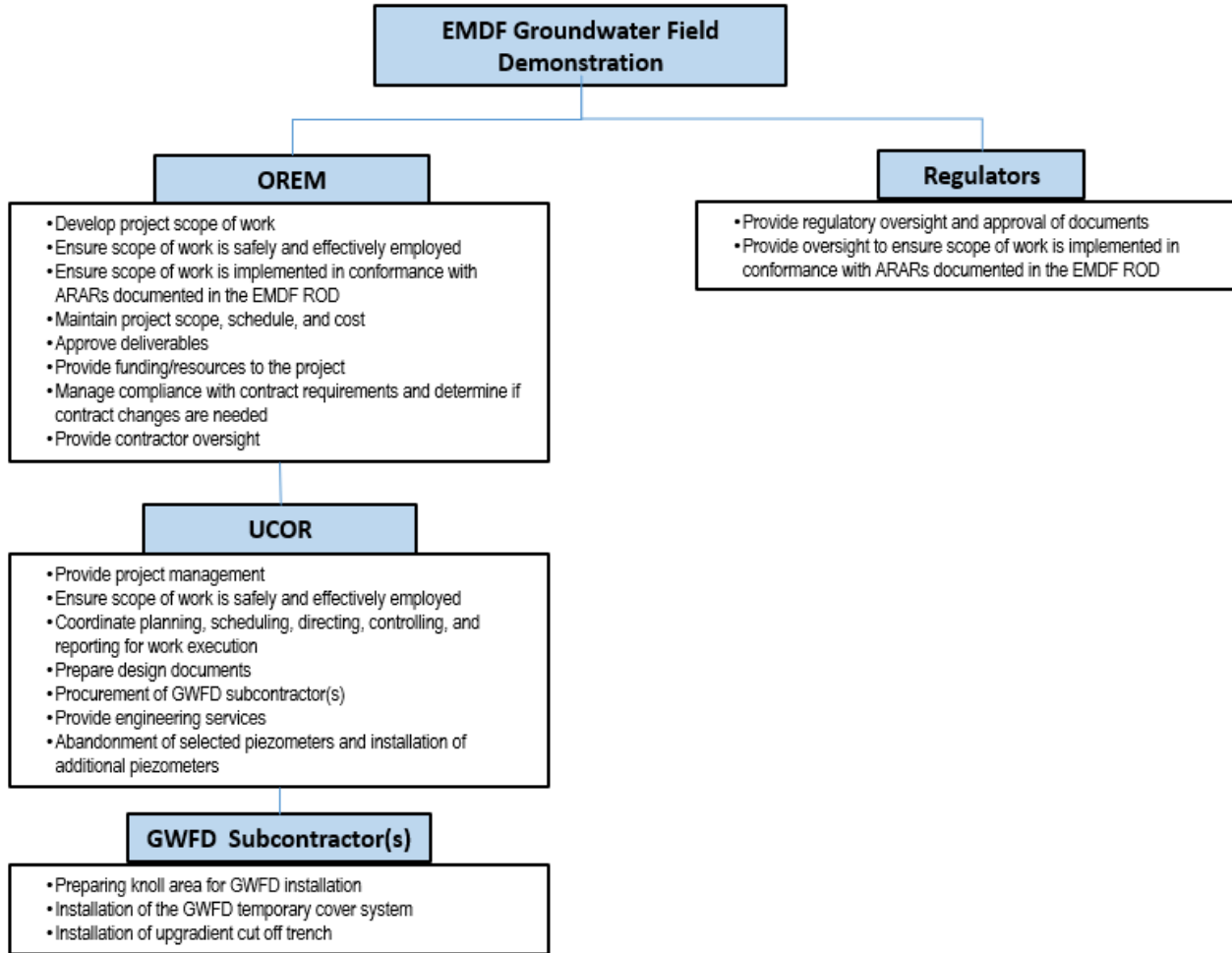

Fig. 1. EMDF GWFD Project organization.

2.1.1 OREM

OREM is responsible for developing the project scope of work; ensuring the work scope is performed in a safe, compliant, and effective manner; and maintaining the project scope, schedule, and costs. OREM is also responsible for approving deliverables and providing funding/resources to the project.

The OREM Federal Project Director (or Deputy) is responsible for maintaining the overall scope, schedule, and costs. The OREM Contracting Officer (CO) and CO Representative are responsible for managing compliance with contract requirements and determining if changes to contracts are necessary or required. OREM staff, including subject matter experts and facility representatives, are responsible for providing general oversight of the contractor's safety and compliance performance.

2.1.2 Regulators

The Tennessee Department of Environment and Conservation (TDEC) and the U.S. Environmental Protection Agency (EPA) have review/approval authority over this scope through reviewing this RDWP/RAWP under FFA protocols. TDEC and EPA may also provide independent oversight and monitoring of associated activities and independent evaluation of results.

2.1.3 UCOR

United Cleanup Oak Ridge LLC (UCOR) is responsible for working with OREM to develop the project scope of work; ensuring the work scope is performed in a safe, compliant, and effective manner; and maintaining the project scope, schedule, and costs.

UCOR will provide additional project management and support oversight for the project, which includes coordination of overall planning, scheduling, directing, controlling, and reporting for the execution of the work. UCOR has prepared the design documents for the road reroute, utilities extensions, borrow area preparations, and the installation of a construction support area.

UCOR will procure services of construction subcontractor(s) for the GWFD activities by preparing draft statements of work, technically reviewing proposals, answering questions, supplying design and site information, and supporting pre-bid meetings, tours, and site access.

UCOR will provide construction oversight for OREM. Oversight will include reviewing submittals, assisting with site access, providing field oversight, conducting construction completion walkdowns, and supporting construction closeout.

UCOR will provide engineering services to OREM for the design.

2.2 PROJECT SCHEDULE

Key activities and dates for the GWFD scope are presented in Table 1. Additional schedule details are provided in Section 9.

Table 1. Key activities and dates for GWFD scope

Activity	Date
GWFD RDWP/RAWP D1 submittal	May 9, 2023 (FFA Milestone 5/31/2023)
GWFD Documents, Reviews, & Updates	Fall 2023
Remove Trees	Winter 2023/Spring 2024
GWFD Construction start approval (CD 2/3)	Fall 2023/Spring 2024
GWFD Construction finish	Spring/Fall 2024
Borrow Area Development -Site 7B	Summer/Fall 2024
GWFD Monitoring, Year 1, Wet Season 1	Winter 2024
GWFD Tech Memo (After Wet Season 1)	Winter 2024/early Spring 25
GWFD Monitoring, Year 2, Wet Season 2	Spring 2025
GWFD Tech Memo (After Wet Season 2)	Winter 2025/Early Spring 26
GWFD Monitoring, Year 1, Wet Season 1	Spring 2026

Note: Results of the field study will be incorporated into the RDR, which will present the final landfill design.

3. SITE DESCRIPTION

The EMDF site is located in CBCV within an upland area located between north-south trending valleys of North Tributary (NT)-10 and NT-11. The site and surrounding areas are forested, except for areas along the south side between Haul Road and Bear Creek Road where the area has been cleared. The cleared area includes a recent soil-staging area along the southern margin and two engineered wetland basins completed in 2015 for the Y-12 National Security Complex (Y-12) compensatory wetland mitigation. Haul Road and Bear Creek Road are located in the southern part of the site and will be relocated to the south prior to EMDF construction as part of the upcoming Early Site Preparation (ESP) activities (Fig. 2).

3.1 GEOLOGY

The GWFD will take place on the central knoll area of the EMDF site, located in CBCV within an upland area located between north-south trending valleys of NT-10 and NT-11. The knoll area predominantly overlies bedrock of the Conasauga Group, primarily the Maryville Formation (Fig. 2). The Conasauga Group formations are predominantly shales, siltstones, and mudstones with little limestone present in the bedrock underlying the proposed disposal cells. The crest of the knoll below the north center of the footprint is underlain by the erosion-resistant Maryville Formation. The typical weathering profile consists of topsoil, silty/clayey soil residuum, saprolite, and fractured bedrock. Recent stream deposits are present along the streams and tributaries throughout EMDF (DOE/OR/01-2819&D1, *Technical Memorandum #2, Environmental Management Disposal Facility, Phase 1 Monitoring, Oak Ridge, Tennessee*).

3.2 GROUNDWATER

Groundwater migrates from the upland areas along Pine Ridge and discharges to stream channels, supporting base flow within the NT streams and Bear Creek. There is also a component of groundwater flow along strike, most notably in the Maynardville Limestone to the south of the EMDF site.

Thirty-two piezometers were installed across the EMDF site between February 2018 and January 2019, to better understand the geology and groundwater elevations at EMDF (Fig. 2). Downhole monitors were installed in each piezometer to collect continuous depth to groundwater, pH, and water temperature data. Note, GW-991 is always dry and no downhole monitor was installed. These have been monitored since installation (excluding periods when individual downhole monitors were not functioning) and many of these are expected to be used for continued monitoring during the GWFD (see Sect. 8.2).

In general, the vertical hydraulic gradients between the shallow and deeper bedrock zones are mostly small (less than 0.03 ft/ft vertical gradient). Three well pairs consistently have a slight downward gradient (GW-978/GW-979, GW-980R/GW-981, and GW-988/GW-989). They are located on the knoll. Slight upward vertical hydraulic gradients have only been observed at well pairs GW-992R/GW-993 and GW-994/GW-995 at the base of the knoll, with a maximum upward gradient of 0.07 ft/ft in the southern part of the proposed EMDF footprint near the existing Haul Road (Fig. 2). Additional information can be found in *Technical Memorandum #2, Environmental Management Disposal Facility Phase 1 Monitoring, Oak Ridge, Tennessee* (DOE/OR/01-2819&D1).

Piezometric surface elevations confirmed that the piezometric surface generally mirrors topography (i.e., is higher topographically beneath knolls/ridges and lower near the tributaries). The piezometric surface responds to rainfall events, indicating recharge is occurring on the site. Seasonal variation is also observed, with higher piezometric surfaces observed during the winter/spring wet season (typically November to March) than in the summer/fall dry season (Fig. 3). The GWFD will be used to determine the extent to which the landfill will lower the piezometric surface to establish the design base of the geologic buffer.

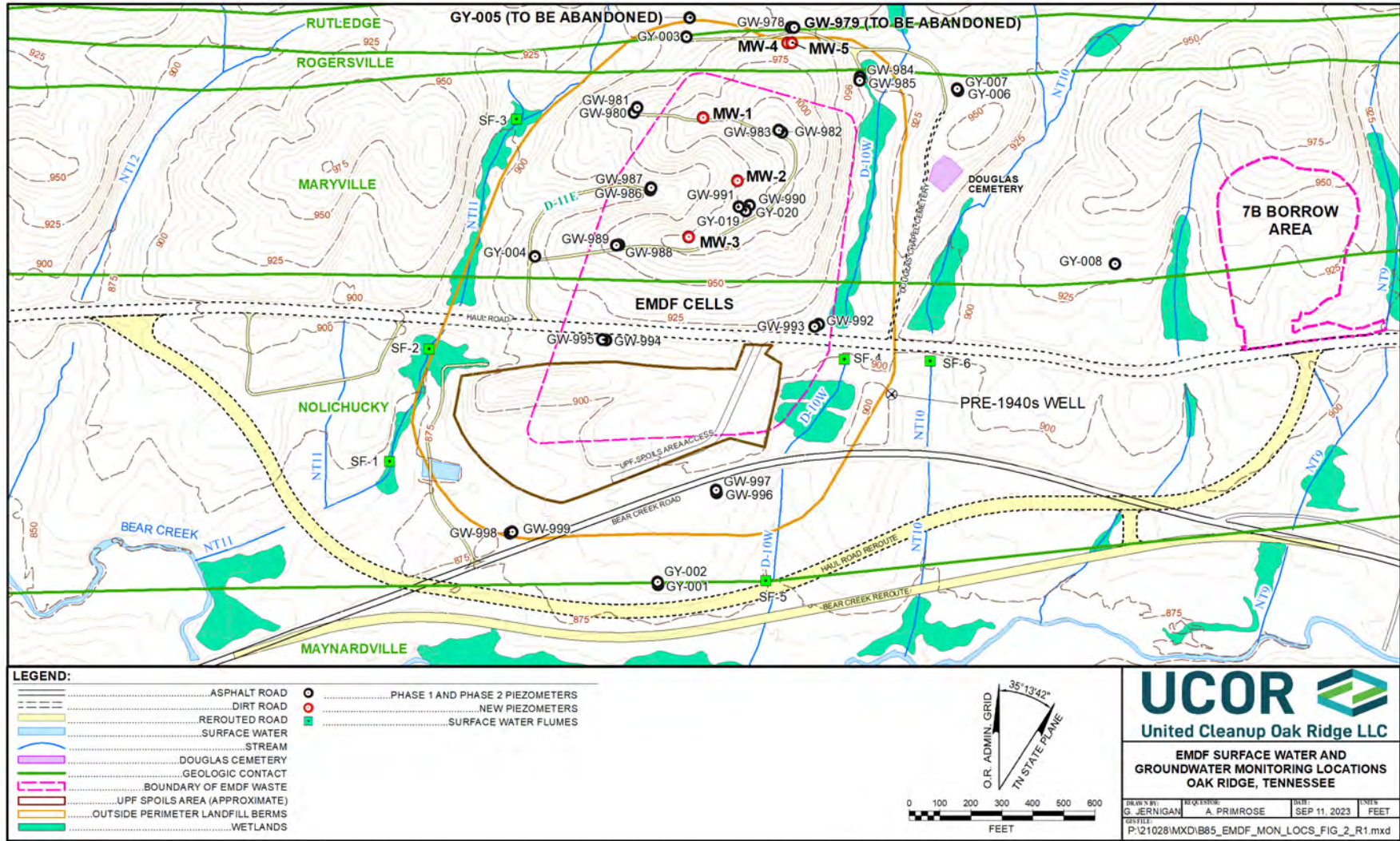

Fig. 2. EMDF area existing piezometers and other features.

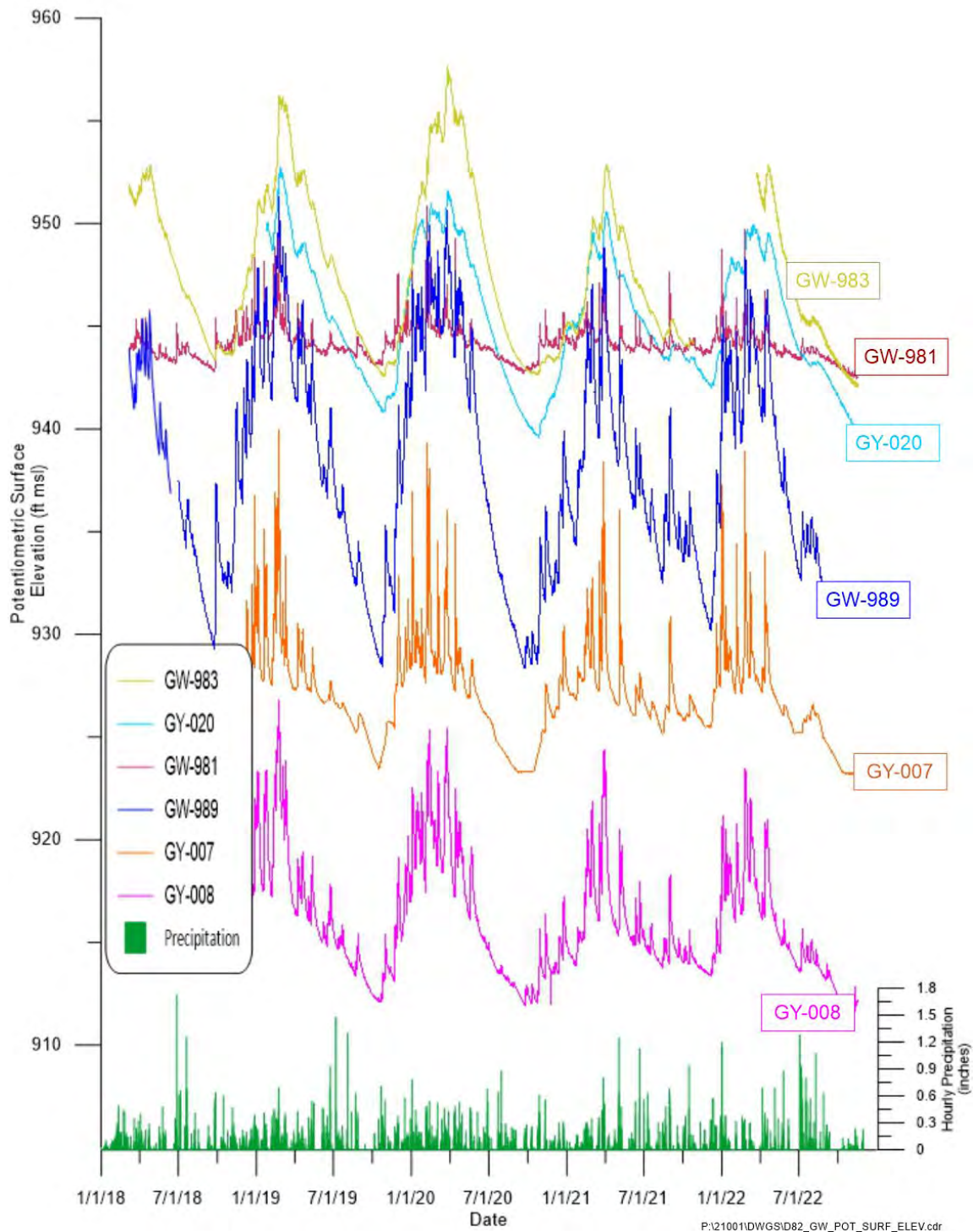

Fig. 3. Seasonal change and response to precipitation in selected shallow piezometers.

As shown in Fig. 3, piezometers respond differently to both seasonal changes and to precipitation based on the location and subsurface conditions. While most piezometers show quick responses to rainfall, GW-981 shows very little seasonal change. GW-981 is surrounded by steep slopes on three sides and infiltration is

relatively quickly drained to surface water and does not cause much of a rise in groundwater elevations. In contrast, most of the other piezometers installed at EMDF show a greater response to precipitation and greater seasonal variation (GW-983, GW-989, and GY-020).

The gradients and piezometric surface confirm that shallow groundwater at the site receives localized recharge in the higher elevations of the site during precipitation events. The tributaries have some influence on the groundwater flow in their immediate areas acting as localized discharge locations (DOE/OR/01-2819&D1, *Technical Memorandum #2, Environmental Management Disposal Facility, Phase 1 Monitoring, Oak Ridge, Tennessee*).

3.3 SURFACE WATER

Surface water drainages near the site include NT-10, NT-11, Drainage (D)-10 West (W), and D-11 East, an east–west trending feature that drains westward into NT-11 near the center of the site (Fig. 2). Surface water flow in these drainage channels flows from Pine Ridge to Bear Creek located on the valley floor. The surface water systems are fed by precipitation, surface runoff and shallow stormflow, and groundwater that discharges via springs and seeps.

Stream flow is primarily a result of precipitation events and from subsequent shallow seeps with limited flow or dry stream conditions during the summer months. Shallow soil can act as a stormflow layer when flow is present, with surface water transport through macropores that result from decaying vegetation such as fallen branches or tree roots (Fig. 4). Stormflow emerges as visible flow further downstream (DOE/OR/01-2819&D1, *Technical Memorandum #2, Environmental Management Disposal Facility, Phase 1 Monitoring, Oak Ridge, Tennessee*). Meandering stream channels filled with sediments are present upstream of the Haul Road culverts, and are not typical of other higher gradient streams found across the ORR.



Fig. 4. Macropores examples in the EMDF area.

Continuous flow monitoring data for NT-10, NT-11, and D-10W were collected for one year as part of Phase 1 site characterization (see flume locations on Fig. 2). The available U.S. Geological Survey base flow data indicate that base flow is continuous along the D-10W, NT-10, and NT-11 stream channels during the winter/spring non-growing wet season (Robinson and Johnson 1995, *Results of a Seepage Investigation at Bear Creek Valley, Oak Ridge, Tennessee, January – September 1994*). Several seeps are located adjacent

to the drainages and tributaries, indicating localized shallow groundwater discharge occurs there at least seasonally.

During the summer/fall growing season with warm and often dry conditions, base flow is negligible and limited to pulsed flow associated with significant storm rainfall events (Robinson and Johnson 1995, *Results of a Seepage Investigation at Bear Creek Valley, Oak Ridge, Tennessee, January – September 1994*). Flow monitoring for Bear Creek downstream of the EMDF site indicates continuous flow in Bear Creek (DOE/OR/01-2695&D2/R1, *Proposed Plan for the Disposal of Oak Ridge Reservation Comprehensive Environmental Response, Compensation, and Liability Act (CERCLA) Waste*).

3.4 ECOLOGICAL RESOURCES

A detailed natural resource evaluation and wetland delineation study was performed over most of the EMDF footprint (Fig. 5). The evaluation is documented in *Natural Resource Assessment for the Proposed Environmental Management Disposal Facility (EMDF), Oak Ridge, Tennessee* (ORNL/TM-2018-515). The natural resource assessment included wetland delineation and evaluation, stream surveys, timber assessments, and rare species surveys (Fig. 5). Walkdowns were also conducted in the fall/winter of 2022 to evaluate an extension of Haul Road reroute and the Spoils Area that were not covered by the initial natural resource evaluation. Additional walkdowns were performed in early 2023 to identify potential bat-roosting trees and to evaluate the ESP areas for potential tri-color bat-roosting locations.

Wetland delineations: Potential wetlands were evaluated for the entire EMDF Project site relative to the dominance of wetland vegetation, soils, and hydrological characteristics. Seventeen wetlands, including one created wetland, were identified within the entire EMDF study area, covering 11.813 acres (Fig. 5). The GWFD and balance of landfill scope was designed and will be constructed to minimize impacts to these wetlands. However, it is anticipated that approximately 6.03 acres of wetland will be disrupted and/or eliminated.

Stream surveys: Five tributary streams are present in the EMDF area: NT-9, NT-10, D-10W, NT-11, and an unnamed tributary between NT-9 and NT-10 (Fig. 5). All are considered first- or second-order streams characterized by low flows during non-rain events, shallow pools and riffles. There are multiple road crossings on these streams, including Bear Creek Road, Haul Road, and some historical roads/culverts across the streams. Many of these road crossings present physical barriers for upstream migration of aquatic fauna, in particular fish, by creating large elevation changes in the stream channel just below culverts. In addition, the upstream side of these culverts often create wetlands with meandering stream channels filled with sediments, not typical of other higher gradient streams found across the ORR.

ESP construction activities will require installation of approximately 900 ft of culverts. Existing culverts were used wherever possible, including the existing culverts and bridge used where Bear Creek Road crosses over Bear Creek. The stream channel for NT-9 is unchanged, except for replacement of an undersized culvert where NT-9 crosses under Bear Creek Road. Additional information on culvert placement is provided in Appendix A. GWFD construction will reroute the stream flow in D-10W to NT-10, impacting both of these drainages. Stream flow in the upper reach of NT-11 adjacent to the GWFD temporary cover will be modified to place the temporary cover system, although the stream will remain in its existing channel. NT-11 upper stream channel modifications may increase in this same area during construction of the berms for EMDF. Neither NT-12 nor the unnamed tributary will be modified.

The Bear Creek watershed is home to a strong population of Tennessee dace, the only fish on the ORR listed as “in need of management” by the Tennessee Wildlife Resources Agency. No Tennessee dace were observed in the tributary streams at the EMDF site during the fish surveys; however, EMDF stormwater

controls will protect Tennessee dace in streams that may be impacted by EMDF construction activities. Prior to performing construction activities, streams will be walked down and sensitive resources, including Tennessee dace, will be relocated.

Timber assessments: As described in ORNL/TM-2018-515, the GWFD area and the balance of landfill outside of the ESP activities are primarily located in hardwood forest, potentially around 60+ years old. Trees with a diameter at breast height (dbh) greater than 10 in. represent approximately 52% of the total forested area. These trees are primarily tulip poplar (~23%), white oak (~16%), red maple (~14%), and sweet gum (~9%). Trees with dbh between 2 and 10 in. are primarily six species: red maple (15.3%), sweet gum (13.9%), loblolly pine (13.5%), tulip poplar (10.7%), sourwood (8.2%), and dogwood (6.0%).

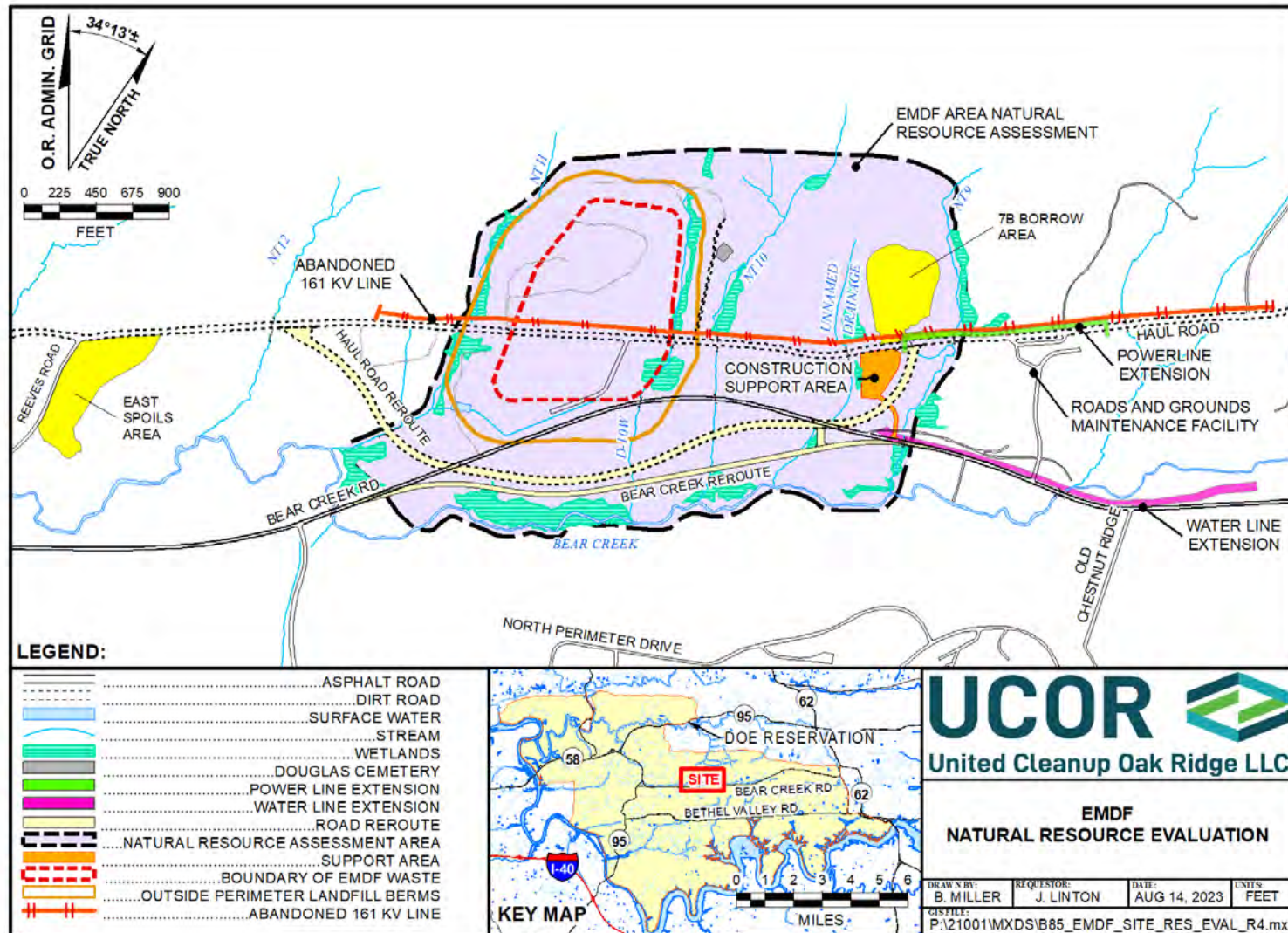

Fig. 5. EMDF natural resource evaluation and EMDF activities.

North of Bear Creek Road, the trees average 508 stems per acre of trees greater than 2 in. dbh with about 48 trees 10 in. dbh or larger per acre. In the 161 acres surveyed for the EMDF Project, 10 trees were identified with a diameter greater to or equal to 30 in. dbh measured at the sample points (tally trees). The tree identified with the greatest dbh in the area was a 38-in. dbh chestnut oak. Of the 10 tally trees identified, six were oak trees.

The EMDF area south of Bear Creek Road was almost entirely subject to timber harvesting during a southern pine beetle outbreak in 2000 and is primarily dense, loblolly pine.

Rare species surveys: Previous investigations to identify threatened and endangered species on the ORR (ORNL/TM-2015/248, *Bat Species Distribution on the Oak Ridge Reservation*), in general, have confirmed the presence of Indiana bats, gray bats, and the northern long-eared bat, all federally listed endangered species; tricolored bats, which are proposed for federal listing; and little brown bats, which are under consideration for federal listing. Results of the bat acoustic surveys indicated that forested portions of the EMDF Project area are used as summer habitat by state- and federally listed bat species. One federally listed endangered species (gray bat) may forage within the site boundaries but does not roost in these areas.

Additional rare species surveys were performed for the EMDF site in 2018. The EMDF Project surveys noted that there did not appear to be large populations of either the northern long-eared bat or the Indiana bat (ORNL/TM-2018-515). No maternity roosts for the Indiana bat were found in the EMDF area. Less than 50 potential bat-roosting trees were identified in the ESP areas, which are primarily forested with loblolly pine, as these are not the preferred roosting trees for bats. Additional evaluation was performed in 2023 to evaluate for the presence of potential roosts of tricolored bats, such as road culverts and riparian buffer zones, and potential roost areas were identified. The GWFD and balance of landfill areas are expected to have larger numbers of potential bat-roosting trees due to the larger hardwood trees present in these areas.

Other threatened and endangered species surveys were conducted by the Oak Ridge National Laboratory (ORNL) in 2018 (ORNL/TM-2018-515). The tubercled rein orchid, listed as threatened on the Tennessee Rare Plant List, was found in wetlands within the study area, particularly in wetlands along the NT-9 and D-10W streams. D-10W and NT-9 both have large populations of rein orchids. As noted previously, NT-9 will only be minimally impacted by GWFD and the remainder of EMDF activities. Two other plant species of interest found were the American ginseng and pink lady's slipper, which are considered of concern because of commercial harvest. The four-toed salamander and the Wood Thrush (state-listed as In-Need-of-Management) were also confirmed to occur throughout forested portions of the study area. Wetlands and drainages within the area were found to contain the highest densities of four-toed salamander breeding sites known on the ORR (Fig. 6).

Approximately 6.03 acres of wetlands will be eliminated by the EMDF Project. During construction of the GWFD and subsequent construction of the balance of the landfill, streamflow in D-10W will be rerouted to NT-10 and the wetlands in D-10W will be eliminated by construction of both the GWFD and balance of landfill. The disrupted wetlands include the engineered wetlands recently constructed in D-10W. The wetlands in NT-11 will also be impacted by these activities (Fig. 6).

No federally listed threatened or endangered bird species were noted during the surveys; however, certain species recorded during the surveys have other state and/or federal management designations. These include dozens of species of birds protected under the Migratory Bird Treaty Act and/or are considered Birds of Conservation Concern by the U.S. Fish and Wildlife Service (USF&WS). The site is on the southern edge of the largest area of contiguous interior forest on the ORR that supports rare bird species. These rare species are not typically found in more fragmented habitats (ORNL/TM-2018-515).

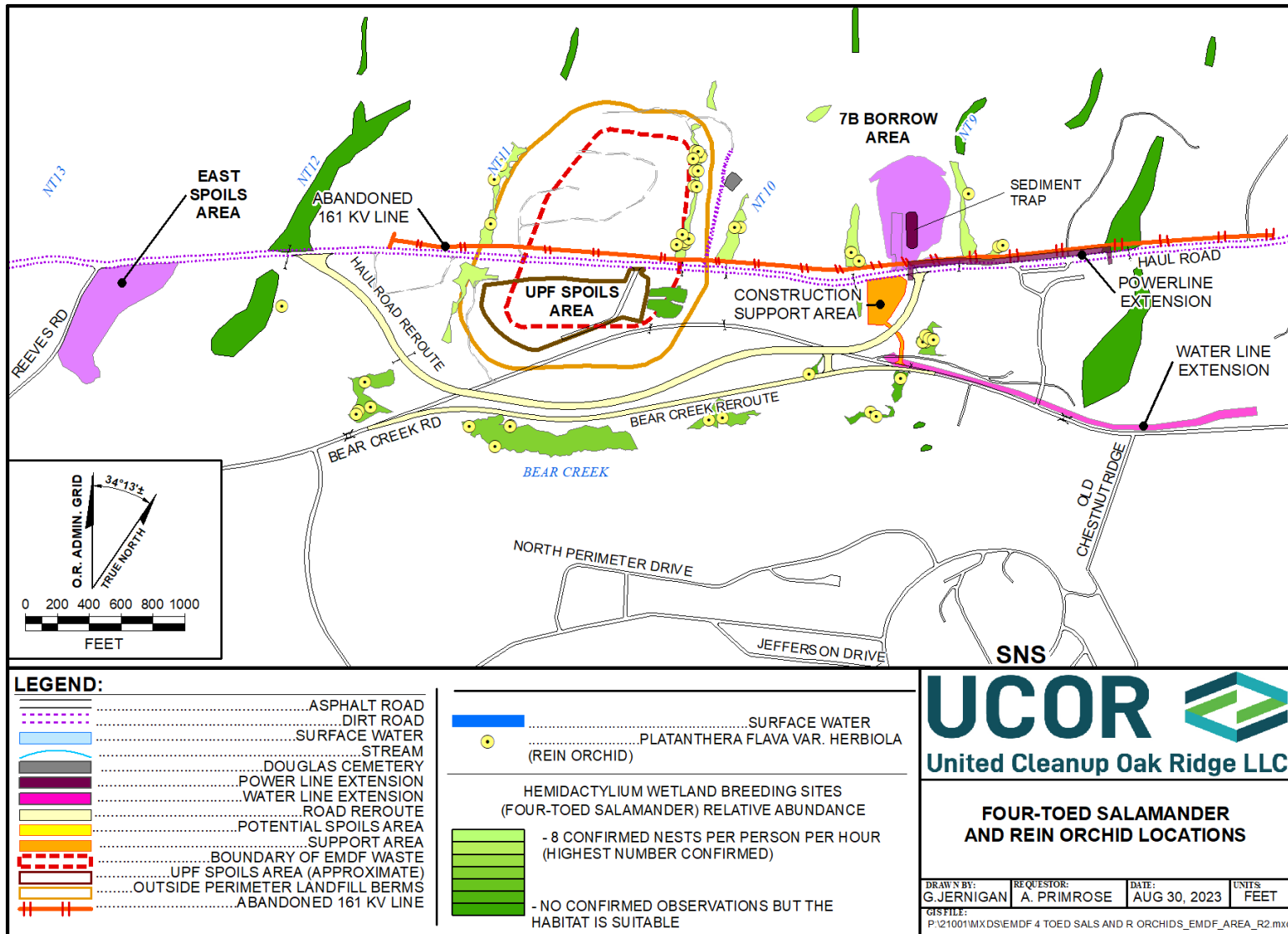

Fig. 6. Four-toed salamander and tubercled rein orchid locations—EMDF area.

The approach to minimize impacts to rare species is as follows:

- UT-Battelle Subject Matter Experts will identify potential bat-roosting trees in the GWFD and balance of landfill areas. These potential bat-roosting trees will be removed prior to start of field work and prior to the start of the foraging season.
- Potential roost areas for tri-colored bats will be identified. Prior to the start of field activities, candidate roosting sites will be fitted with one-way devices to allow bats to exit but not return.
- Fish and aquatic wildlife sweeps and removal will be conducted prior to start of construction activities, including prior to culvert grouting or replacement, given the possible presence of crayfish and four-toed salamanders in all drainages. Although Tennessee dace have not been detected in the EMDF drainages, these will be included in the sweeps and relocated if present.

As part of the approach to minimize impacts, during spring 2023, four-toed salamanders and their nests were identified in the wetlands planned to be impacted by EMDF construction (ESP, GWFD, and balance of landfill). The salamanders and nests were relocated or are planned to be relocated to other suitable habitat that will not be impacted by EMDF construction. Similarly, the tubercled rein orchids are planned to be identified and relocated to suitable habitat in 2023, prior to GWFD construction in the impacted wetlands.

Appendix A contains additional information on the sensitive resources present in the GWFD and balance of landfill areas. Mitigation identification is in progress for both the GWFD and balance of landfill areas. Any mitigation required for the ESP activities will also be performed as part of the overall EMDF GWFD/landfill construction effort. Once finalized, the required mitigation will be documented in the D2 GWFD RDWP/RAWP or as an addendum to this document.

3.5 CULTURAL RESOURCES

The Douglas Chapel Cemetery and four historical home site/structures are present near the EMDF site (*Phase I Archaeological Survey of the Proposed Environmental Management Disposal Facility in Central Bear Creek Valley, Roane County, Tennessee*, CRA 2018). Douglas Chapel Cemetery is located on the knoll between NT-10 and D-10W. DOE intends to avoid and preserve the Douglas Chapel Cemetery, as well as maintain access to the cemetery for visitors.

The four home sites were demolished when the federal government purchased the land for the Manhattan Project. A prehistoric habitation was located near Bear Creek where lithic flakes were found, an indication of prehistoric tool production. All the sites were highly disturbed and appeared to contain no buried cultural deposits. The sites were not recommended for inclusion in the National Register of Historic Places.

No historically significant sites are located within the GWFD area. The Douglas Chapel Cemetery is located nearby, but will not be disturbed by either GWFD or landfill construction activities (Fig. 6).

4. PROJECT DESCRIPTION

4.1 OVERVIEW AND DESIGN APPROACH

The objective of the GWFD is to determine the seasonal high post-construction groundwater table that will control the final design elevation of the geologic buffer in the knoll area, where the seasonal high groundwater elevations sometimes exceed the preliminary design base. As described in Sect. 3.2, current groundwater elevations vary considerably between the wet and dry seasons and respond quickly to precipitation events.

Ideally, the GWFD would excavate to the base of the geologic buffer and place the landfill liner system for the most accurate determination of post-construction groundwater levels. However, this approach is not practical as a demonstration. Therefore, the GWFD will be accomplished by placing a temporary, low-permeability cover system over the EMDF knoll area, then directly measuring seasonal high (wet season) groundwater elevations to estimate future post-construction groundwater elevations. These seasonal high groundwater elevation measurements will be used to establish the design base of the geologic buffer.

The disposal cells will be separated from Pine Ridge by a saddle formed by NT-11. This saddle reduces shallow groundwater recharge from Pine Ridge area from the north. Recharge is expected from Pine Ridge to the shallow groundwater within the stormflow layer within soil and shallow bedrock. Recharge will continue from Pine Ridge to the regional, deeper bedrock groundwater system.

The EMDF disposal cells will be located between NT-10 and NT-11 (Fig. 2). The channel of the NTs and D-10W are lower than the preliminary design base of geologic buffer. The D-10W channel is at a slightly higher elevation than the NTs, but its stream channel is still lower than the proposed base of the geologic buffer adjacent to the corresponding stream segment.

The preliminary design of the landfill liner system was based on groundwater modeling that predicted a decline in shallow groundwater elevations from placing the low-permeability liner system over the landfill area, eliminating localized recharge from precipitation. The landfill design assumed that without local recharge to the knoll, shallow groundwater elevations would decrease to levels similar to the elevations of NT-11 and NT-10, lower than the design base of the geologic buffer. The design also includes a stormflow interceptor channel upgradient of the disposal cells to intercept stormflow and eliminate this source of recharge from Pine Ridge through the stormflow layer within soil and shallow bedrock.

As previously noted, the current peak groundwater elevations in the highest areas of the knoll are occasionally higher than the elevation of the base of the geologic buffer in the preliminary design (piezometers locations are shown in Fig. 2 and discussed in Sect. 8.2). Therefore, as documented in the EMDF ROD, the GWFD is being performed in the knoll area to determine the seasonal high groundwater elevation that will control the final design elevation of the geologic buffer in the knoll area. The GWFD will provide additional characterization information and has the potential to affect the final design of the EMDF disposal cells in the knoll area.

The GWFD will require removal of the soil and weathered rock stormflow zone in the footprint area of the knoll area and covering the area with a low-permeability layer to approximate placement of the landfill liner system. The GWFD area is based on the current Phase 1 Preliminary Design layout of the landfill in the knoll area, including the associated berms.

In accordance with the EMDF ROD, the GWFD design and results of the field study will be incorporated into the EMDF landfill RDR, which will present the final landfill design; the EMDF landfill RDR is a primary document that requires approval by the FFA parties before landfill construction. The approved

EMDF landfill RDR will serve as the basis for a final landfill design that will meet the RAO to maintain a 15-ft separation between the bottom of emplaced wastes and the seasonal high water table of the uppermost unconfined aquifer, which includes 5 ft of liner system and 10 ft of geologic buffer, consistent with TDEC 0400-11-01-.04(4)(a)(2).

The study area will be modified to approximate the constructed landfill in the knoll area by installing a temporary cover system to shed rainwater that would otherwise infiltrate into the ground to minimize the effects of groundwater recharge in the project area. The temporary cover will direct stormwater into local, existing drainages, as will be done following EMDF disposal cell construction. Groundwater elevations will be measured in key shallow piezometers during two wet seasons (December through March or April). Evaluation of water levels measured during the study's first wet season will be used to support base geologic buffer elevations for the final landfill design, as described in the EMDF ROD (DOE/OR/01-2794&D2/R2).

The major assumptions and requirements used to develop the GWFD are as follows:

- Required for the knoll area where current, peak groundwater levels are higher than the preliminary design base of the geologic buffer.
- Requires excavation of soil and stormflow zone in the knoll area with sufficient excavation to provide a stable and safe working surface.
- Places a temporary low-permeability cover system over the knoll area.
- Requires surface water and stormflow cutoff and rerouting of flow from D-10W to NT-10.
- Requires stormwater controls in D-10W, NT-10, and NT-11 to address increased runoff and redistribution of surface water flow and sediment control.
- Requires Haul Road and Bear Creek Road reroute prior to construction of sediment basins as part of ESP activities. If sediment basins are not available, then alternative sediment control measures will be used until the sediment basins are operational, such as hay bales and straw wattles.
- Requires existing geophysical boreholes, piezometers within construction zones and other potential sources of surface water migration to groundwater to be abandoned prior to GWFD construction.
- Maintains select existing shallow piezometers in the GWFD area for use after demonstration construction. Existing deeper piezometers (the deeper piezometer of each pair) will be maintained as possible and practical, but will not be used for the GWFD evaluation.
- Existing piezometers outside the groundwater demonstration area will be maintained and monitored for evaluation of the GWFD groundwater elevation results.
- Additional piezometers will be installed and screened at the base of the geologic buffer to refine and increase lateral coverage so that interpretation of results between piezometers is minimal. Evaluations will use linear interpolation between piezometers.
- Groundwater elevation monitoring over a minimum of one wet season will demonstrate groundwater levels relative to the base of the geologic buffer. Final landfill design will proceed after evaluation of the data from the first wet season. Groundwater elevation monitoring will also be performed for an additional wet season to refine the design, if necessary.

4.2 KEY GWFD-RELATED FEATURES OF THE LANDFILL DESIGN

The GWFD is designed to approximate the effects from construction of the EMDF landfill in the knoll area. The EMDF landfill design includes elements that will remove local recharge from precipitation, intercept

stormflow from Pine Ridge, and divert stormwater. The key elements of the landfill design that must be approximated by the GWFD include the following:

- Upgradient stormflow interceptor channel at the northern boundary of the disposal cell that is designed to collect and reroute stormwater/storm flow from Pine Ridge.
- The liner system and the geologic buffer prevent infiltration and eliminate recharge from precipitation and eventually leachate.

The preliminary landfill liner system and geologic buffer design are above the elevation of the surrounding drainages, eliminating the potential for groundwater recharge from surface water and allowing groundwater beneath the disposal cells to stabilize to the adjacent tributary elevations. This design feature is not expected to change as a result of the GWFD. As a note, the base of the geologic buffer in the preliminary design was set 5 ft above the modeled post-construction seasonal high groundwater table to be more conservative.

4.3 GWFD DESIGN

The GWFD will approximate the design approach for the EMDF disposal cells to determine how construction of the landfill will affect groundwater elevations in the knoll area. The upgradient stormflow interceptor channel will be designed and constructed to support both the GWFD and the landfill. However, because the design of the primary and secondary liner systems may be altered as a result of the data collected by the GWFD, it is impractical to excavate and construct the geologic buffer, primary, and secondary liner systems at this time. Therefore, an alternative cover design was selected to simulate the effect of the landfill liner on groundwater in the knoll area by minimizing infiltration in the landfill disposal cell area.

The key elements of the GWFD are (1) upgradient stormflow interceptor channel and (2) a temporary cover system designed to simulate the conditions of the final landfill liner system configuration, such that infiltration and upgradient lateral recharge is cut off to the GWFD footprint. In addition, stormwater controls will be designed and incorporated into the GWFD to minimize impacts to the NTs and Bear Creek, such as construction of the sediment basins that will also be used for landfill construction and operation (Fig. 7).

4.4 GWFD AREA

The GWFD is designed to evaluate post-landfill construction groundwater elevations in the EMDF knoll area where current seasonal high shallow groundwater levels are higher than the preliminary design elevation of the geologic buffer.

Upgradient stormflow also must be diverted and infiltration must be limited across the knoll area to approximate the effects from installation of the EMDF landfill liner system, resulting in anticipated higher stormwater flows and stream flow within the adjacent drainages. Therefore, impacts to wetlands and streams must be minimized as much as possible. The cover area was selected to cover the majority of the knoll area from the saddle between the knoll and Pine Ridge to the north to approximately the existing Haul Road in the south, and from immediately adjacent to NT-11 on the west to D-10W on the east (Fig. 7). Wetlands will be avoided as much as possible along NT-11, but will be removed within D-10W due to the need to grade the eastern slope of the cover area to provide a stable subgrade for the GWFD temporary cover, and eventually to place the eastern landfill berms. The wetlands are shown on Fig. 6 with the EMDF landfill design for comparison.

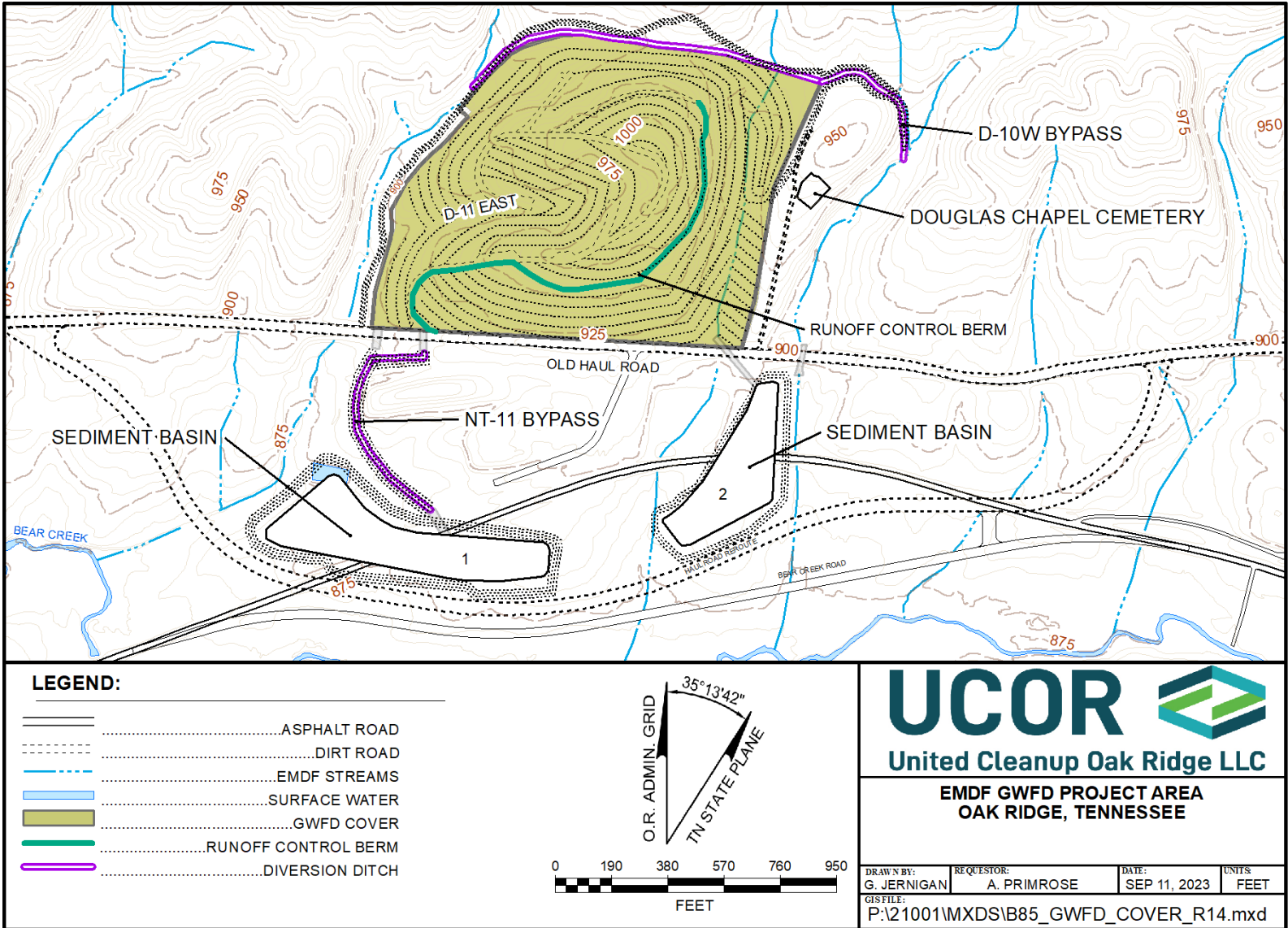

Fig. 7. GWFD Project layout.

5. APPLICABLE OR RELEVANT AND APPROPRIATE REQUIREMENTS

The applicable or relevant and appropriate requirements (ARARs) from the EMDF ROD are those required for natural and cultural resources protection and for the landfill design. Most of the design ARARs are not applicable to the GWFD, because the GWFD is a temporary covers system. The applicable ARARs are provided in Appendix B and were considered and applied during development of the GWFD design.

The approach for implementing the natural resource ARARs is provided in Fig. 8 below.

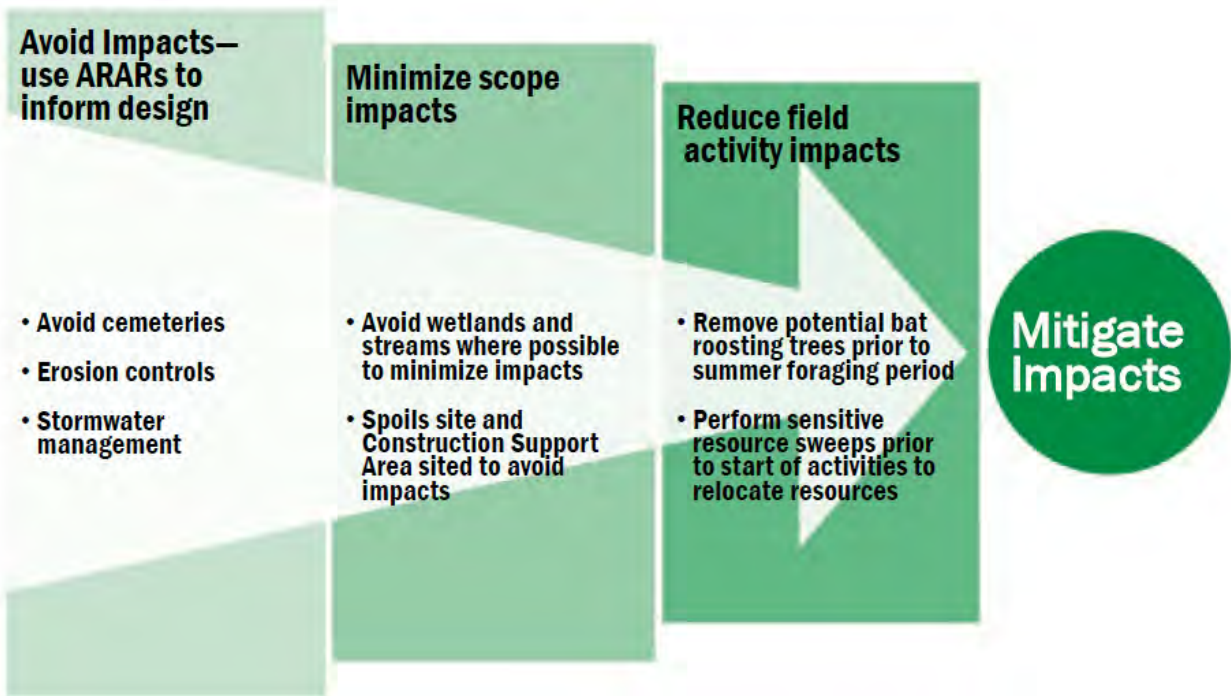

Fig. 8. EMDF GWFD approach to natural resource ARARs.

This page intentionally left blank.

6. GWFD IMPLEMENTATION AND APPROACH

Verification, monitoring and operations, and maintenance plans are not required because this action consists of new construction in an area undisturbed by activities on the ORR. GWFD activities will be performed under the purview of UCOR's existing programs and procedures, including health and safety, quality assurance (QA)/quality control (QC), and waste management. In addition, GWFD activities will comply with environmental laws and regulations identified in the EMDF ROD as ARARs.

The *Stormwater Management Requirements for Groundwater Field Demonstration for the Onsite Waste Disposal Facility, Oak Ridge, Tennessee* (UCOR-5620) supports the GWFD clearing and grading activities and presents erosion and sediment control best management practices (BMPs). Sediment and erosion control is further discussed in Sect. 6.5.

Sediment/erosion control measures will be designed in accordance with the guidance presented in the *Tennessee Erosion and Sediment Control Handbook* (TDEC 2012).

Design drawings and specifications for the key design elements are provided in Appendix C. These include site grading, the upgradient stormflow **interceptor channel**, and the temporary cover system. Field QCs are included with the specifications as appropriate.

6.1 SITE PREPARATION

Prior to construction of the GWFD design features, the initial stormwater controls will be installed. Prior to placement of the temporary cover system, the existing grade in the GWFD area will be stripped to a depth of approximately 4 ft to remove unsuitable materials and provide a safe, stable working surface. Additional cuts will be required in certain areas to develop the appropriate grades (Appendix C).

The uppermost soil unit is a mixed colluvium and residual soil unit with organics that contains unsuitable soils for GWFD subgrade; this material will be stockpiled for later use as topsoil. This upper zone also includes the majority of shallow macropores that increase transmissivity of stormwater and result in an unsafe working environment. The exact depth of stripping will be determined in the field based on the materials encountered, and could be increased in areas where organic, soft/saturated, and highly transmissive materials are present after stripping the upper 4 ft. This material is also unsuitable for subgrade and will be stockpiled for later use as nonstructural fill material. **These spoils are expected to be placed in the Spoils Area (Fig. 6).**

6.2 UPGRADE STORMFLOW INTERCEPTOR CHANNEL

Upgradient stormwater/**stormflow** from Pine Ridge will be diverted away from the GWFD area along the course of the current saddle between the knoll and Pine Ridge. The stormflow interceptor channel will be installed at the northern boundary of the GWFD. The **stormflow** interceptor channel sides will be sloped at a 2 horizontal to 1 vertical (2H:1V) grade and lined with geotextile covered with riprap to prevent erosion. **the** south side of the **stormflow** interceptor channel serves as an anchor trench for the north side of the GWFD cover system (Figs. 9 and 10).

Grading for the GWFD, and also for the future disposal cells, will cover the former D-10W channel. Therefore, the D-10W headwaters will be diverted to NT-10 **as a continuation of the stormflow interceptor channel**. These features are key to controlling run-on stormwater flows around the facility and maintaining

the integrity of the perimeter berms (Figs. 5 and 7). The stormflow interceptor channel is adequately sized to reroute run-on through the surficial soil layers north of the site, which is a key element for groundwater management. The stormflow interceptor channel will extend from NT-11 to the west, and to the D-10W diversion and NT-10 to the east. Flow through the stormflow interceptor channel will be from the central divide to NT-11 to the west, and to NT-10 to the east. The outfall to the D-10W diversion and the stormflow interceptor channel are the culverts installed as part of ESP activities that convey NT-10 flow under Haul Road. All run-on controls are designed to convey the 25-year 24-hour storm event with enough capacity to convey the 100-year 24-hour storm event without overtopping.

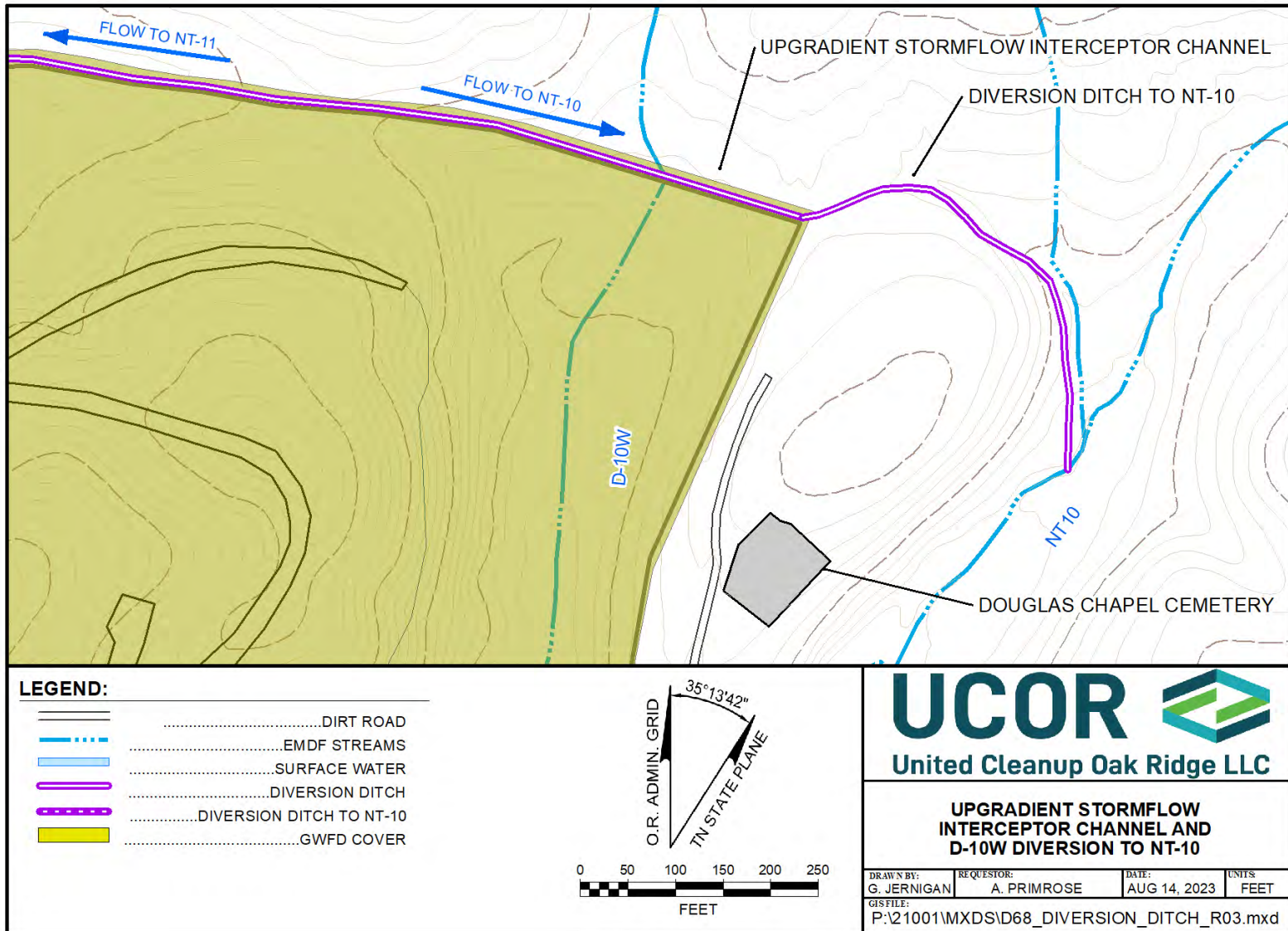

Fig. 9. Upgradient stormflow interceptor channel.

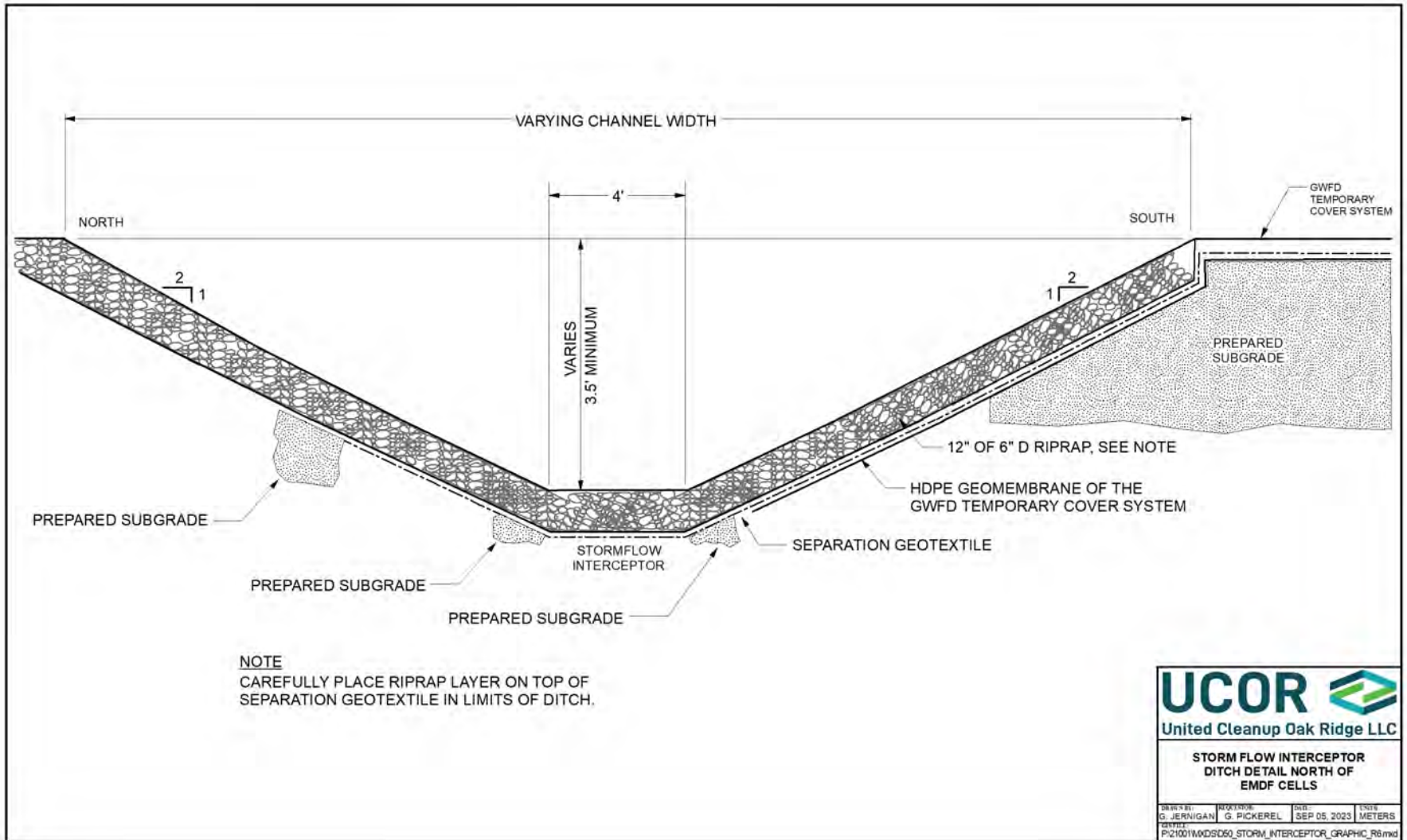

Fig. 10. Design details for the upgradient stormflow interceptor channel.

6.3 TEMPORARY COVER SYSTEM

The civil layout and grading for the temporary cover system were designed with the following requirements:

- Establish a subgrade elevation that removes the high-infiltration stormflow zone and organics layer to support effective cover infiltration control, and removal of additional material below this zone to support an efficient earthwork balance (provide embankment fill for backfill).
- Establish grades such that the final cover system, stormwater features, berms, and access roads are stable within the cover system.
- Develop support roads required to access both the existing piezometers to remain and the proposed new piezometers, as well as to support effective cover operations and maintenance.
- Establish grades sufficient to route all overland stormwater to two newly constructed sediment basins south of the old Haul Road.

Figure 11 provides a cross-section view of the cut and fill required across the knoll to develop a stable, well graded surface to place the temporary cover system. Figure 11 also shows the runoff ditches and associated berms that direct runoff off the temporary cover. The plan view of the runoff ditches and associated berms is shown on Fig. 7.

6.3.1 Design Basis and Requirements

The temporary cover system will be placed over a prepared subgrade to provide a stable working surface. The area will be graded to provide positive drainage away from the cover and to direct stormwater flow to the sediment basins. In addition, roads for piezometer access and maintenance will be developed as part of the grading. The cover system key design elements and performance objectives are provided in Sect. 6.3.5.

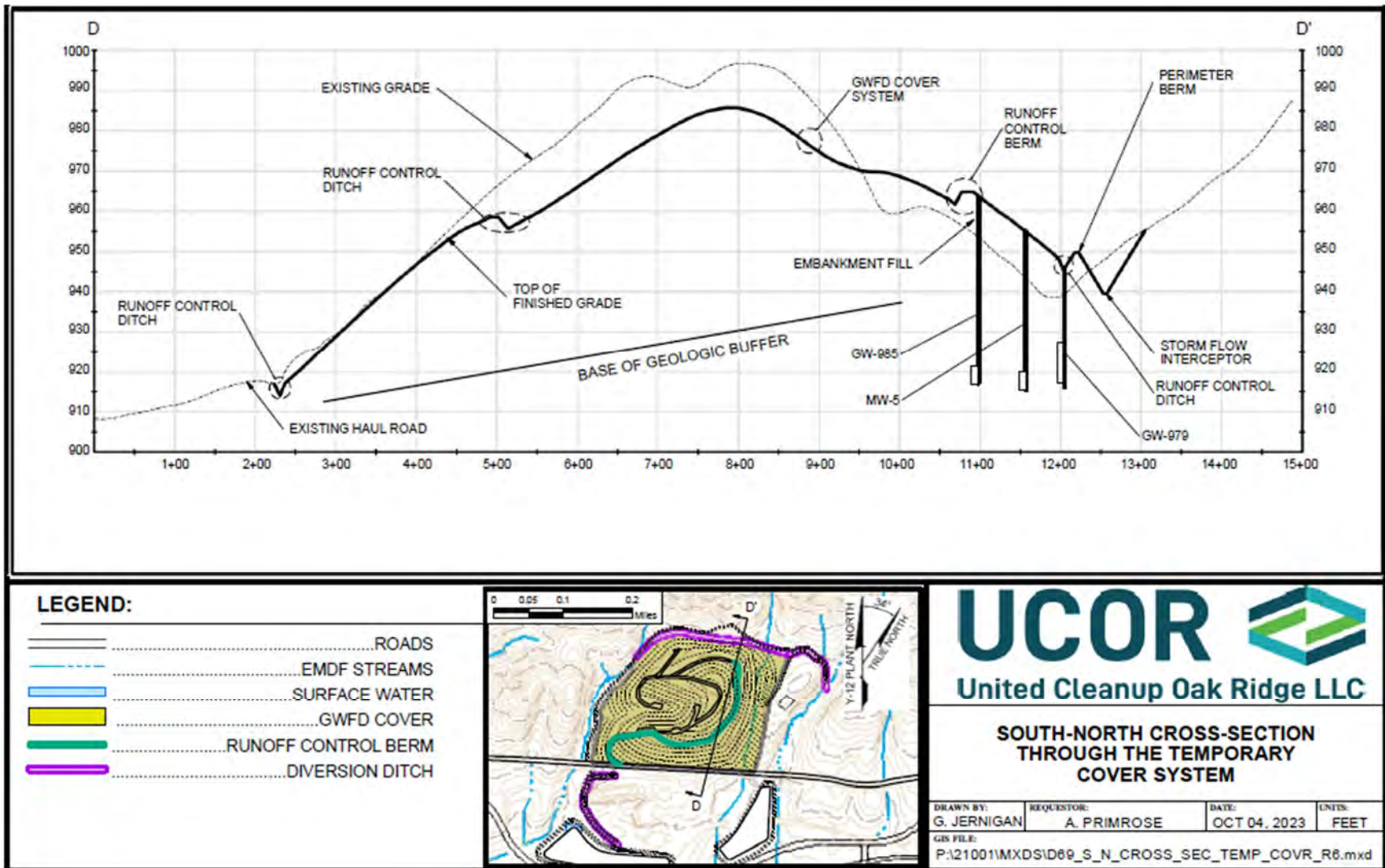

Fig. 11. GWFD south-north cross-section through temporary cover.

The following key design bases were used to develop the design for the temporary cover:

- Maintaining the Douglas Chapel Cemetery in its current state
- Ensure seismic design of the project follows TDEC *Earthquake Evaluation Guidance Document* (TDEC 1994) for design and operation of Class I and Class II solid waste landfills in Tennessee and Resource Conservation and Recovery Act of 1976 (RCRA) Subtitle C/D guidance (40 *CFR* 258.14).
- Use the seismic hazard mapping (2014) incorporated in ASCE 7-16, *Minimum Design Loads and Associated Criteria for Buildings and Other Structures*, and ICC 2018, *International Building Code (IBC)*. Use of the 2014 instead of the updated 2018 seismic hazard mapping is slightly more conservative and therefore appropriate for this design. The design seismic event for ASCE 7-16 corresponds to an event with a 2% probability of exceedance in 50 years (2500-year return period), which is similar to the recurrence interval of approximately 2373 years as required by TDEC and RCRA.
- Static global stability and veneer stability design criteria are based upon recommendations used in standards of practice for slope stability evaluations, including USACE 2003 (*Slope Stability*), USBR 2011 (*Embankment Dams*), and Koerner and Soong 2005, (“Analysis and Design of Veneer Cover Soils.” Seismic stability criteria are defined by TDEC (1994) guidelines.

6.3.2 Site Clearing and Grubbing

Initially, sweeps of the area will be conducted to relocate sensitive resources such as four-toed salamanders and tubercle rein orchids. Trees, brush, and other vegetation will be removed from the GWFD area. If possible, merchantable trees will be harvested by an ORR contractor for beneficial reuse. Potential bat-roosting trees will be removed prior to the bat foraging season. If the timing is acceptable, these will be removed at the same time as the remaining trees. Stumps, tree root balls, slash piles, and other unsuitable materials will be removed. This material will be removed and turned into wood chips for future use on the GWFD or other projects.

Topsoil will be stripped from areas that will be disturbed by excavation, filling, or compaction and will be stockpiled/staged in an area such as the Spoils Area. Topsoil will be reused for the project areas or placed into the Spoils Area. Where practical, wetlands soils will be reused for other sites and projects. Soils unsuitable for fill material will be stripped from the project site and staged in the Spoils Area for future use as possible nonstructural fill material.

6.3.3 Subgrade preparation

The civil and grading layout requirements are:

- Develop subgrade elevation that removes the high-infiltration stormflow zone and organics layer to support effective cover infiltration control, and remove additional material below this zone to support an efficient earthwork balance (provide embankment fill for backfill) and safe working surface.
- Develop grades such that the final cover system, stormwater features, berms, and access roads are stable within the cover system.
- Develop grades sufficient to route all overland stormwater to two newly constructed sediment basins south of the old Haul Road.
- Develop support roads required to access both existing and proposed new piezometers, as well as support effective cover operations and maintenance.

The maximum finished grade will be 3H:1V, except in stormwater drainage ditches as described in Sect 3.2. Access roads will be constructed as 2-lane roads with 10-ft lanes. Spur roads will be 12 ft wide with a turnaround point.

The final surface of the temporary cover is shown in Fig. 7. Figure 11 (cross-section) shows a representative cut and fill across the site that removes the highly transmissive upper 4 ft of material along with removal of additional material to achieve a stable and safe working surface that allows drainage away from the temporary cover to nearby drainage ditches, drainages and northern tributaries. Unsuitable soils will be removed, and may be staged in the Spoils Area, then the area will be backfilled with competent soil. Use of explosives for excavation is not allowed.

After reaching grade, ground surface will be uniformly compacted and prepared for placement of the cover system. Cut slopes will be designed and constructed to drain stormwater with precautions to control erosion and prevent sediment releases.

6.3.4 Cover System Anchor Trenches

The outside edge of the geomembrane will be buried in shallow anchor trenches located on the outermost edge of the temporary cover system to hold the geomembrane in place. Anchor trenches are not present along all sides of the temporary cover. In locations where the geomembrane is under an adequate length of riprap, the geomembrane is held in place with riprap. Anchor trenches will be excavated into the prepared subgrade after the perimeter embankments and prepared subgrade are complete.

6.3.5 Temporary Cover System

The GWFD temporary cover system consists of (from bottom to top) a high-density polyethylene (HDPE) geomembrane (the low-permeability layer), an engineered turf for stormwater and erosion control, and overlying sand infill of the turf layer to weigh down the temporary cover and resist wind uplift (provides ballast). The sand infill also aids in dispersing precipitation to minimize erosion, and in protecting the cover system from vehicle damage (Fig. 12). The geomembrane will be placed on the prepared subgrade described in Sect. 6.3.3 above.

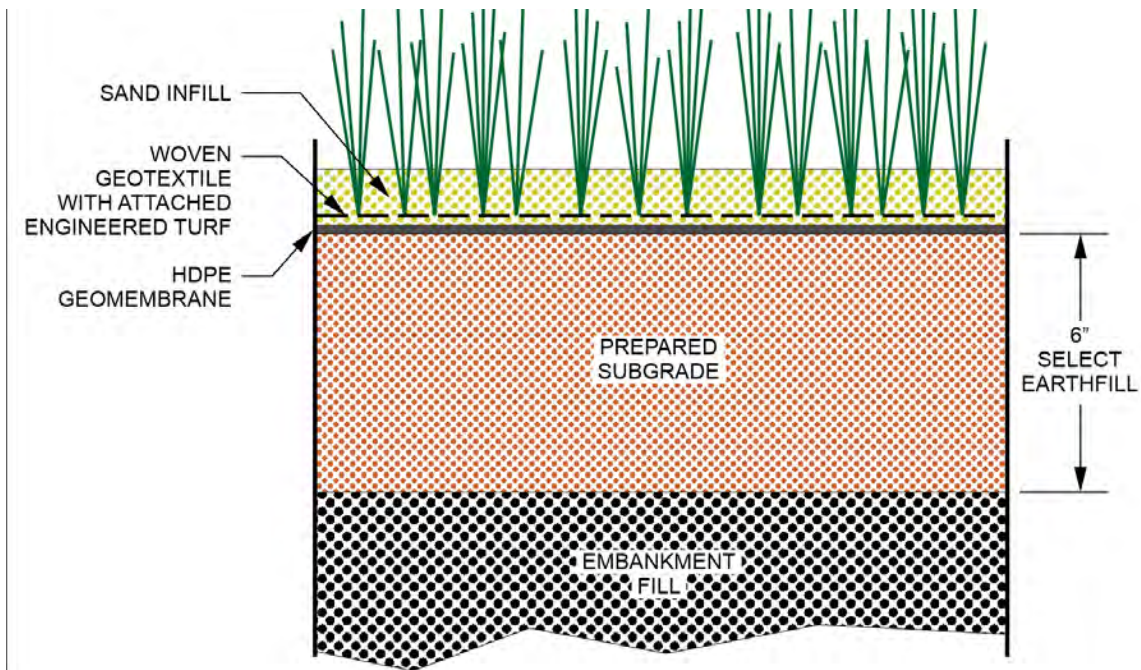

Fig. 12. Design details for the temporary cover system.

The temporary cover system will be installed from the upgradient stormflow interceptor trench southward to Haul Road and from NT-11 eastward to D-10W (Fig. 7). The HDPE geomembrane will be installed over prepared subgrade generated from earthwork activities as shown on Fig. 12.

The key design requirements for the GWFD cover system were as follows:

- Design a temporary cover system over the study area to divert precipitation and runoff to approximate the elimination of infiltration into the ground expected from the constructed landfill cells.
- Perform as designed to remain intact for a period of 2 years during the monitoring period, with inspection and repairs to reduce infiltration. However, the cover system will remain in place until construction of the landfill.
- Include a geosynthetic liner material that forms a low permeability barrier. The geosynthetic liner material is the overall term used to describe the 2-component cover system. This system consists of an HDPE geomembrane placed on a prepared soil surface and is overlain by a layer of synthetic turf. The geosynthetic liner must be capable of deployment on a prepared subgrade and must be capable of being sealed around piezometer penetrations.
- Material must be capable of being welded where panels overlap to maintain consistent engineering properties across the liner, which will minimize leakage.
- Materials must be durable and resistant to damage from environmental conditions, including ultraviolet deterioration, chemical degradation, wind, and stormwater runoff for a minimum period of 5 years.
- The cover must support construction of overlying system components for stormwater management, erosion control, and roadway access for operations, maintenance, and monitoring activities.

6.3.5.1 HDPE geomembrane

The 50-mil HDPE geomembrane selected will meet the following requirements:

- No manufacturing defects, deterioration from ozone, ultraviolet, or other exposure to elements for 20 years
- No defects in material and factory seams for 2 years
- No defects from installation for 2 years

The selected HDPE will contain no plasticizers, fillers, extenders, reclaimed polymers, or chemical additives, except 2-3% carbon black to provide ultraviolet resistance and not more than 1.5% antioxidants and heat stabilizers, as required for manufacturing. The HDPE will be smooth, with no ridges of textured geomembrane, and no factory seams.

The HDPE will come in rolls with a width of approximately 22 ft and lengths selected to reduce field seams. The minimum requirements are provided in Table 2. Seams will have a minimum 4-in. overlap and will be welded and quality tested as described in Appendix C.

Table 2. HDPE geomembrane properties

Property	Requirement (MARV)	Test Method
Thickness (min. avg.)	47.5 mil	ASTM D5199, Modified Note 1, or ASTM D5994
Asperity Height (min. avg.)		ASTM D7466
1. Drainage Stud	130	
2. Friction Spike	175	
Density	0.94 g/cc	ASTM D792, Method B
Tensile Properties (avg. both directions)		ASTM D6693, Type IV
1. Tensile Stress @ Break	110 lb./in width	
2. Tensile Stress @ Yield	110 lb./in width	
3. Elongation @ Break	200%	
4. Elongation @ Yield	12%	
Puncture Resistance	80 lb.	ASTM D4833
Tear Resistance	38 lb.	ASTM D1004, Die C
Carbon Black Content (%)	2 to 3	ASTM D4218
Oven Aging at 200°C		
Standard OIT (min. ave.) - % retained after 90 days	140	ASTM 3895
Environmental Stress Crack Resistance	500 hours	ASTM D5397 Single Point NCTL Test

6.3.5.2 Engineered turf component

Overlying the HDPE geomembrane will be a synthetic structure material consisting of geotextiles tufted with polyethylene yarns to resemble grass blades. The color of the polyethylene yarns has not been selected, but is expected to be a color that resembles partially dried grass to better blend in with the environment (expected to be brownish green).

The engineered turf is expected to come in 14-ft-wide rolls. The lengths will be selected to reduce field seams. The minimum requirements are provided in Table 3.

Table 3. Engineered turf properties

Property	Requirement (MARV)	Test Method
Total Product Weight (minimum)	20 oz/sq. yd.	ASTM D5261
CBR Puncture	1500 lb.	ASTM D6241
Tensile Strength of Product	1,600 lb./ft	ASTM D4595
Tensile Strength of Yarn	15 lb.	ASTM D2256
Interface Friction Between Engineered Turf and Textured Geomembrane (min. Peak)	35°	ASTM D5321
UV Stability (retained strength at 100 years projected)	>60%	ASTM G147

The engineered turf will be installed similarly to the geomembrane, except that seams are expected to have a minimum 5-in. overlap. Seams will be fused and quality tested as described in Appendix C.

6.3.6 Sand Infill

A fine-grained uncompacted sand infill shall be placed over the engineered turf and consist of competent washed material less than 3/8 in. in diameter. The sand infill will be 1/2 to 3/4 in. thick as measured with a digital caliper or equivalent.

6.3.7 Maintenance of the Temporary Cover System

Monthly inspections will be performed during the GWFD monitoring period, looking for areas where the cover has settled or eroded. The cover's drainage features and anchor trenches will be inspected looking for areas of erosion or other damage.

The temporary cover system is designed to withstand storm events. Therefore, inspections will be conducted if a weather event has occurred that has the potential to displace significant amounts of sand from the cover system, such as a short-duration/high-intensity storm event (30-min. storm event with 1 in. or more precipitation) or the 10-year storm event with 4.64 in. over 24 hours.

6.4 BORROW AREA 7B DEVELOPMENT

Installation of the GWFD cover system requires both additional fill material and storage for the topsoil and unsuitable material removed from the GWFD area. While excavated material will be used for fill material if suitable, additional fill material is required to bring the surface to an acceptable grade for placing the temporary cover. Therefore, the Site 7B Borrow Area (Fig. 2) will be developed to support the GWFD, and will continue to operate to support EMDF construction following completion of the GWFD.

Initial site preparation at the Site 7b Borrow Area will be performed as part of the ESP activities and will be completed prior to start of the GWFD Project. The previously constructed features include construction of an access road, a staging area, and stormwater management measures (sediment pond and ditches). The access road will extend approximately 91 ft from the existing Haul Road to the staging area. The staging area will be an area approximately 67 by 261 ft, sufficient to provide for parking of approximately 15

personal vehicles and 5 bays for heavy equipment parking, as well as room for an operations trailer, or similar, and chemical toilets.

Trees identified as potentially used for bats to roost during the summer will be removed during the period from November 15th through March 31st, per agreement with the USF&WS, prior to development of the borrow area. No aquatic resources are anticipated in this area. The initial area of the borrow area will be cleared and grubbed prior to the start of borrow operations, including removal of marketable timber. Topsoil will be removed and staged in a prepared area, either at the 7b Borrow Area or a nearby location.

A newly constructed sediment trap will be approximately 0.25 acre in size, built in an existing swale, to allow sediment control for the entire 5-acre borrow area based on a 5-year, 24-hour design storm (TDEC 2012). Construction of the sediment trap will require excavation of borrow soil due to the slopes present at the borrow area. The excavated material is expected to be used for structural fill for the GWFD. The location of the sediment trap is shown on Fig. 6.

Sediment and erosion controls will be developed for both the active borrow area and the topsoil pile, as described in Sect 6.5.

6.5 SEDIMENT AND EROSION CONTROL

The *Stormwater Management Requirements for Groundwater Field Demonstration for the Onsite Waste Disposal Facility, Oak Ridge, Tennessee* (UCOR-5620, in progress) supports the GWFD clearing and grading activities and presents erosion and sediment control BMPs. Sediment and erosion control BMPs anticipated to be incorporated include:

- Minimizing disturbed areas
- Controlling stormwater runoff
- Stabilizing disturbed soils as soon as practical
- Protecting slopes and storm inlets downgradient from the work area
- Establishing perimeter controls
- Retaining sediment onsite

Sediment/erosion control measures will be designed in accordance with the guidance presented in the *Tennessee Erosion and Sediment Control Handbook* (TDEC 2012).

GWFD construction activities are to be phased to minimize the amount to disturbed areas exposed at any given time. Perimeter runoff controls, including silt fences, straw wattles, and construction exits will be installed prior to clearing and grubbing. Clearing, grubbing, stripping, and grading will only occur in designated construction areas where improvements are planned. Natural features and vegetative soil cover outside of the construction areas will be protected to avoid disturbance to trees or vegetative cover and to minimize soil erosion.

The following erosion and sediment control BMPs will be applied for the GWFD construction activities:

- Control of stormwater flowing onto and through project area
 - Straw wattles: serve as run-on diversion, runoff filtration, water velocity dissipation
 - Check dams: installed in swales and ditches to reduce velocity in channels and thereby reduce erosion

- Diversion berm: divert rainwater away from the cut slopes and control stormwater flowing onto the project
- Stabilization of soils
 - Hydromulching: protect exposed soils. Wood chips may be used as available and effective.
 - Seeding and straw mulch: lawn areas will be seeded and stabilized with straw or similar mulching material
 - Roadway gravel/road base: placed on all areas receiving vehicular traffic (access roads and staging areas)
- Protection of slopes
 - Erosion-control blankets: used to stabilize slopes in swales, cut slopes, and sediment basin
- Protection of storm drain inlets
 - Straw wattles: protection for storm drain inlets (catch basins) until permanent vegetation has been established
- Perimeter controls and sediment barriers
 - Silt fences: installed along the toe of fill slopes and around topsoil stockpiles
- Stabilized construction exits
 - Anti-tracking pads: installed at project egress locations to minimize the offsite transport of sediment by construction vehicles
- Dust control: use of a water truck to apply water to disturbed areas to control dust

Additional BMPs not presented here may be incorporated as needed. Impacts to waterbodies will be minimized through implementation of BMPs.

Erosion and sedimentation control during construction will be through use of silt fences, inlet and outlet protection at culverts and catch basins, grass-lined and riprap-lined ditches, filter rings, and other erosion- and sedimentation-control measures. Erosion-control matting will be installed on slopes steeper than 4:1 and all ditches not lined with riprap. Straw wattles will be installed along the contour (across the slope) to intercept water running down a slope. Completed slopes, ditches, and other areas will be seeded and mulched within 15 days of completion of site grading.

Sediment basins will be placed for sediment control for the GWFD and construction/operation of the landfill disposal cells. These basins will collect stormwater and surface water runoff from the GWFD and future landfill disposal cells. These sediment basins are expected to be placed in the vicinity of the existing Haul Road, which will be rerouted as part of the ESP activities for the EMDF landfill (Fig. 7). Details on the sediment basins sizing and design are provided in Appendix C.

Run-on to the GWFD from the cemetery hill east of the GWFD will be controlled by a drainage ditch that is located over the cover in the in-filled former D-10W channel and routed to discharge into the newly constructed Pond 2 south of the old Haul Road.

Stormwater runoff control ditches and two culverts will direct runoff to a series of culverts, conveying stormwater flow under Haul Road. All runoff controls are designed to convey the 25-year, 24-hour storm with enough capacity to convey the 100-year, 24-hour storm event without overtopping.

This page intentionally left blank.

7. WASTE MANAGEMENT

This section identifies the sanitary and industrial waste streams that are expected to be generated during the GWFD activities. The GWFD activities will occur in uncontaminated areas; therefore, waste materials are expected to be disposed at the Oak Ridge Reservation Landfills (ORRLs). A summary of waste stream characterization during GWFD activities is provided in Table 4, which describes, quantifies, and defines waste streams, and identifies the expected disposal outlet(s). While contaminated waste streams are not anticipated, if discovered or generated, DOE will notify EPA and TDEC and those waste streams will be evaluated and characterized for disposal at EMWMF or other suitable disposal facility.

Vegetation removed during GWFD activities is not expected to be waste. Marketable timber will be harvested as possible and practical, segregated, and removed. The remaining vegetation is expected to be used at the EMDF site for mulch and/or erosion control (some of which may be chipped). Vegetation removal and management will be in accordance with the Stormwater Management Requirements Plan and BMPs. The remaining vegetation will be evaluated for other beneficial use as practical. Secondary waste generated during the primary waste-generating activities is expected to be disposed with the primary waste streams.

Table 4. Summary of wastes generated by GWFD activities

Waste Stream	Expected waste type	Estimated volume	Characterization basis	Planned disposition site
Construction debris, bags/containers and PPE,	Sanitary	50 cy	PK, radiological surveys	ORRL
Misc. trash and organic garbage (e.g., food waste)	Sanitary	10 cy	PK, radiological surveys	ORRL
Hydraulic line spill cleanup material	Sanitary	<5 cy	PK, radiological surveys	ORRL
Associated secondary waste (PPE, plastic sheeting, tools, rags, wipes)	Sanitary	10 cy	PK, radiological surveys	ORRL

ORRL = Oak Ridge Reservation Landfills
 PK = process knowledge
 PPE = personal protective equipment

It is assumed that unused materials (e.g., surplus materials) from the construction of the temporary cover system will be removed from the site by the subcontractor performing the work and will not be a waste stream managed during this activity. If it is disposed onsite, it will be disposed at the ORRLs.

This page intentionally left blank.

8. SAMPLING AND ANALYSIS PLAN

8.1 OBJECTIVES

The GWFD will be performed in an area undisturbed by ORR activities. As described in Chap. 1, seasonal groundwater elevations will be measured following construction of the GWFD cover system to determine the seasonal high post-construction groundwater surface that will control the final design elevation of the base of the geologic buffer. Where practical, straight line interpolation between data points will be performed to eliminate the need to interpret or model results.

Although D-11E area will drain surface water, the drainage will be partially filled in as part of placing the GWFD cover system, and covered with impermeable material. It will no longer act as a drain for the groundwater.

8.2 PIEZOMETERS

Shallow piezometers will provide the best representation of post-construction seasonal high groundwater elevations at the geologic buffer depths. Where possible, the existing shallow piezometers will be maintained during construction of the GWFD to allow ready comparison to pre-GWFD conditions.

There are three existing shallow piezometers where the seasonal high potentiometric surface is higher than the projected bottom of the geologic buffer. The shallow piezometers were selected because these most accurately reflect shallow groundwater elevations closest to the elevation of the geologic buffer. These piezometers are shown in Table 5 and in Fig. 14 and are:

- GW-983—at the top of the knoll
- GW-989—further down the knoll
- GY-020—located between GW-983 and GW-989

In addition, Fig. 11 south-north profile provides general information about the knoll area, but does not have the listed piezometers. Figure 13 (east-west profile) provides information about the knoll area and the final landfill design. This figure shows the relationship between the screened interval for GW-983 and the geologic buffer.

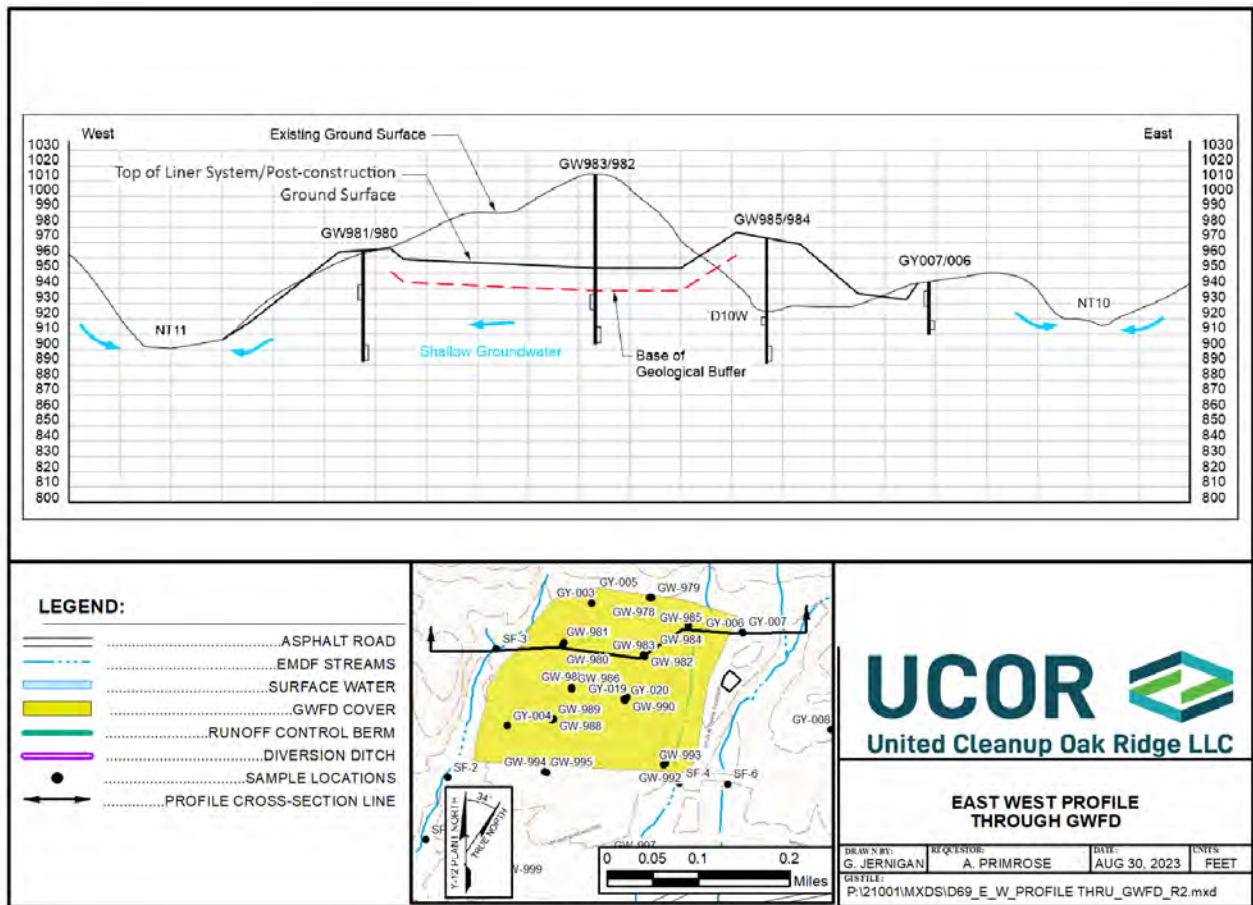

Fig. 13. EMDF east-west profile.

The shallow piezometers to be used for the GWFD are in the knoll area. These are provided in Table 5 (along with other nearby piezometers) and shown in Fig. 14. With the exception of GW-979 and GY-005, which will be abandoned, these existing piezometers will be protected during GWFD construction, with casing extended or shortened, as necessary. Following completion of GWFD construction activities, protective surface casing and well pads will be reinstated, and the piezometers will be protected, as necessary. Methods to protect piezometers will avoid penetrating the liner system.

Deeper piezometers will also be protected and maintained, as practical, but will not be used for determining the post-construction groundwater elevation at the base of the geologic buffer.

Table 5. EMDF average seasonal high and low groundwater elevations—shallow piezometers/GWFD area

Piezometer	Formation	Current seasonal high groundwater elevation higher than bottom of geologic buffer (Y/N)	GWFD monitoring status	Comments
GW-979	Rutledge/ Rogersville	N/A	To be abandoned	Outside landfill cells, within upgradient cut-off trench
GW-981	Maryville	No	To remain	Outside landfill cells, projected geologic buffer
GW-983	Maryville	Yes	To remain	Within landfill cells, screened below geologic buffer
GW-985	Maryville	N/A	To remain	Outside landfill cells
GW-987	Maryville	No	To remain	Significant fill area (D-11E)
GW-989	Maryville	Yes	To remain	Within landfill cells, screened near geologic buffer
GW-991	Maryville	N/A	To remain	Dry
GW-993	Nolichucky	No	To remain	Seasonal high water table is within 3 to 4 ft of the base of the geologic buffer.
GW-995	Nolichucky	No	To remain	
GY-003	Rutledge/ Rogersville	N/A	To remain	Outside landfill cells
GY-004	Maryville	N/A	To remain	Outside landfill cells
GY-005	Rogersville/ Rutledge		To be abandoned	Outside landfill cells, within upgradient cut-off trench
GY-007	Maryville	N/A	To remain	Outside landfill cells
GY-008	Maryville/ Nolichucky	N/A	To remain	Outside landfill cells
GY-020	Maryville	Yes	To remain	Within landfill cells, screened near geologic buffer, shallow pair to GW-990

Note: Shallow piezometers were selected as most representative of groundwater elevations closest to the elevation of the geologic buffer

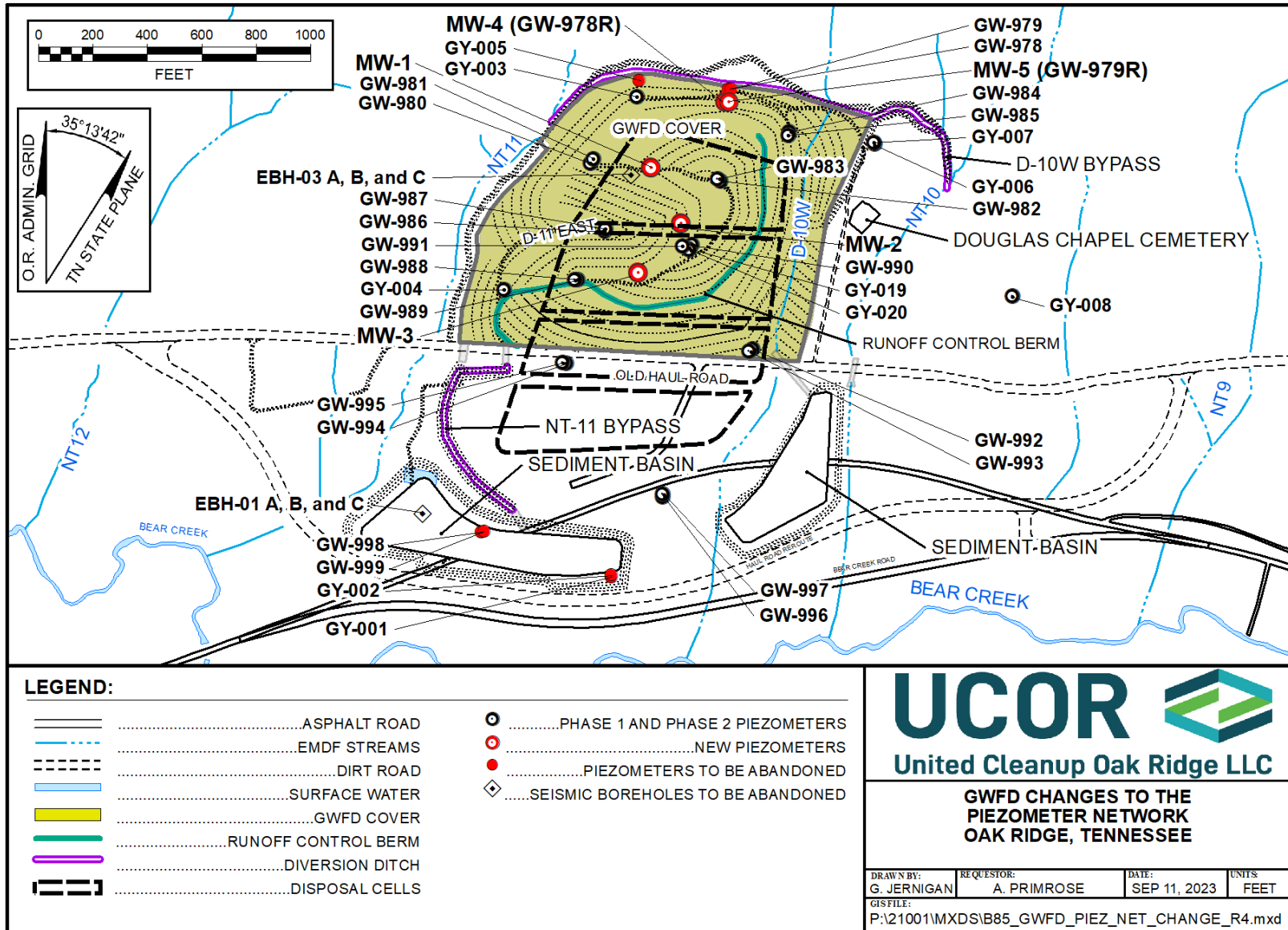

Fig. 14. Changes to piezometer network.

8.2.1 New Piezometers to be Installed

Three new shallow piezometers are expected to be installed to allow more straight-line interpolation of data between existing piezometers to define the seasonal high groundwater table (Fig. 14). An additional two piezometers are being added to replace a piezometer pair to be removed during the upgradient stormflow trench construction.

- New piezometer MW-1, lower on the knoll to the west
- New piezometer MW-2, lower on the knoll between GW-983 and GY-020
- New piezometer MW-3, lower on the knoll to the southeast
- MW-4 and -5, deep/shallow pair replacements for abandoned piezometers GW-978 and -979

The approximate piezometer locations are presented in Fig. 14. Actual investigation locations will be determined in the field, based on accessibility or site conditions encountered at the time of drilling. Locations will be surveyed by a licensed land surveyor (including horizontal position and ground surface elevation at each new piezometer within 0.1 ft and the top-of-casing elevation of each piezometer within 0.01 ft).

Lithologic information will be obtained from the boreholes at each location. The shallow piezometers will be constructed of 2-in. polyvinyl chloride pipe, with the base of the well screens at the approximate elevation of the bottom of the geologic buffer zone. Boreholes and piezometers will be constructed by Tennessee-qualified monitoring well drillers in accordance with ORR requirements, as specified in *Standard Specification for Well Drilling, Installation, and Abandonment* (SPG-00000-A005).

Selected construction details are provided in Table 6. Note, a 5-ft screen interval was selected to ensure that groundwater elevations measured were targeted to the base of the geological buffer that is critical to the design and reduce the possibility of having to interpret results.

Table 6. GWFD additional piezometer construction information

Piezometer	Formation	Projected ground surface elevation (ft amsl)	Elevation of base of geologic buffer (ft amsl)	Total depth (ft)	Screened interval	Comment
MW-1	Maryville	975.7	940.4	37.5	32 -37 ft bgs* 938.7 – 943.7 ft amsl	
MW-2	Maryville	966.5	931.2	37.5	32 -37 ft bgs* 929.5 – 934.5 ft amsl	
MW-3	Maryville	967.6	926.0	45	47-52 ft bgs* 923.1 – 928.1 ft amsl	
MW-4	Rogersville	955.0	n/a	70	59.5 - 69.5 ft bgs* 895.5 – 888.5 ft amsl	Replaces GW-978
MW-5	Rogersville	954.8	n/a	40	34.5-39.5 ft bgs* 920.3 – 915.3 ft amsl	Replaces GW-979

amsl = above mean sea level

*ft bgs = ft below projected (new) ground surface

Following construction, measures will be taken to protect the piezometers until the final configuration of the GWFD cover is reached. Bollards are not expected to be placed to avoid penetrating the cover. Other methods may be selected to protect the piezometers such as jersey barriers. Piezometers shall be developed as

specified in *Standard Specification for Well Drilling, Installation, and Abandonment*. Piezometers shall be developed no sooner than 24 hours after installation and shall continue until the piezometer responds to water-level changes and produces clear, sediment-free water to the extent possible. Following development and similar to the other EMDF piezometers, dedicated downhole monitors will be placed in each piezometer to measure pH, temperature, and groundwater elevation. Data will be collected continuously and recorded every hour.

8.2.2 Piezometer, Seismic Boreholes, and Well to be Abandoned

Three piezometers on the north side of the knoll will be abandoned. These are located within the area that will be disturbed by installation of the upgradient stormflow cutoff trench. Four additional piezometers located in the western sediment pond area will be abandoned (Table 7). Piezometers will be abandoned in accordance with the ORR requirements as specified in *Standard Specification for Well Drilling, Installation, and Abandonment*.

Table 7. GWFD piezometers to be abandoned

Piezometer	Shallow/ Deep	Reason
GY-005	Shallow	Within upgradient cut-off trench
GW-978	Deep	Within upgradient cut-off trench
GW-979	Shallow	Within upgradient cut-off trench
GW-998	Deep	Within western sediment pond area
GW-999	Shallow	Within western sediment pond area
GY-001	Deep	Within western sediment pond area
GY-002	Shallow	Within western sediment pond area

While remaining piezometers will be protected, if additional piezometers are damaged beyond repair during construction activities, these will be abandoned in accordance with *Standard Specification for Well Drilling, Installation, and Abandonment*.

Six seismic boreholes will be abandoned as part of the GWFD Project. These are located in sets of three at two different locations (Fig. 14):

- EBH-01 A, B, and C—southeast of SF-1
- EBH-03 A, B, and C—on the knoll midway between GW-981 and GW-983 in the vicinity of new piezometer MW-1

In addition, the pre-ORR settler-era water well on the EMDF footprint will be abandoned at this time. This well is approximately 32 ft deep and is located south of SF-4 (Fig. 2). The well represents a potential pathway to groundwater. A groundwater level will be collected prior to abandonment and the data will be provided to EPA and TDEC.

8.2.3 GWFD Monitoring Summary

All piezometers that will be monitored for the GWFD are provided in Table 8 and shown on Fig. 15.

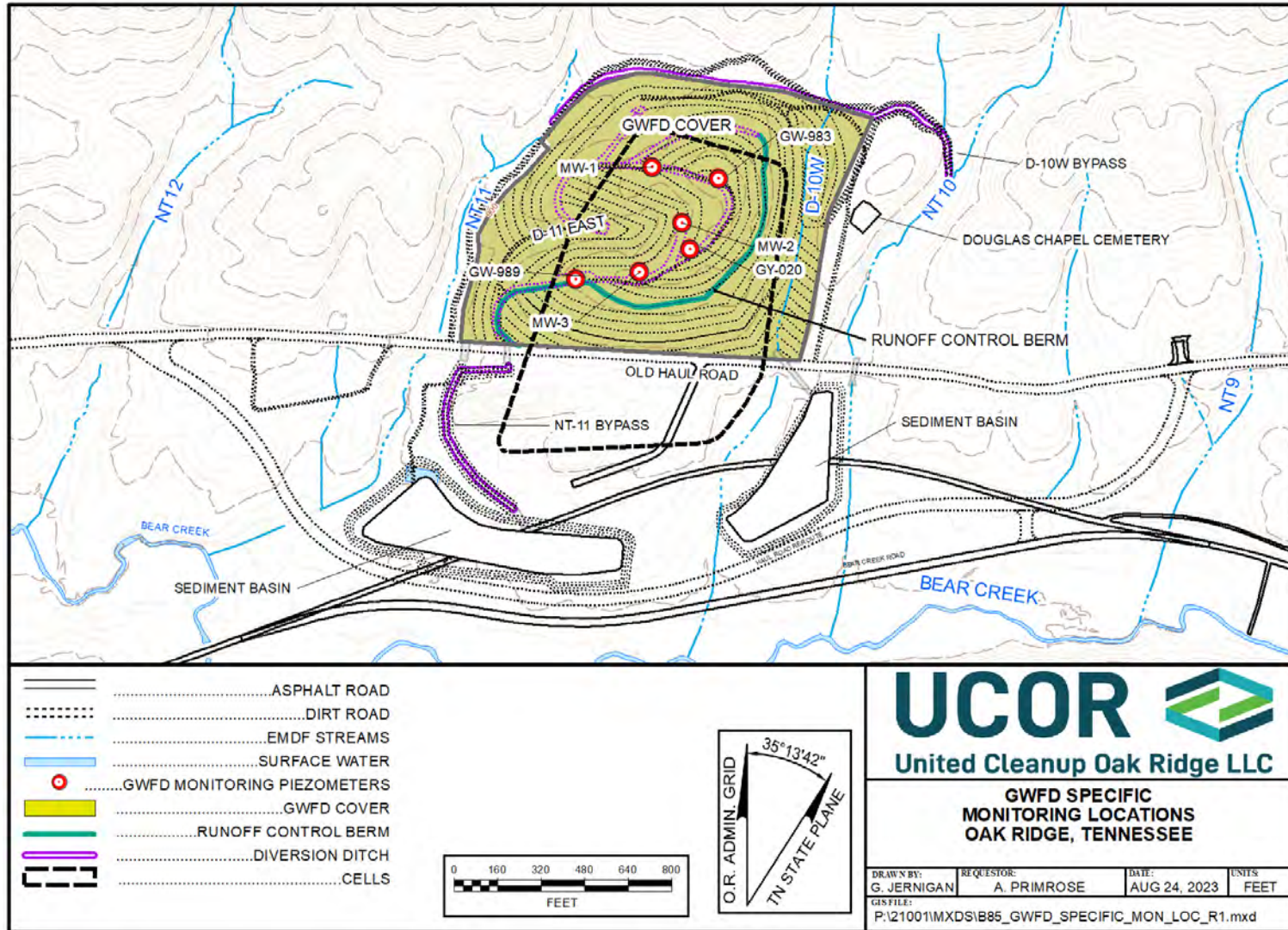

Fig. 15. GWFD monitoring locations.

Table 8. GWFD monitoring piezometers summary

GWFD monitored piezometer	Geologic Fm	Elevation base of geologic buffer (ft amsl)*	Seasonal high wet weather elevation February 2019 (ft amsl)	Modeled post-construction groundwater elevation (ft amsl)	Piezometer depth (ft bgs)	Piezometer depth (ft amsl)	Screened interval (ft bgs)	Screened interval (ft amsl)	Approximate elevation NT-11 channel along strike west of piezometer (ft amsl)	Approximate elevation NT-10 channel along strike east of piezometer (ft amsl)
GW-983	Maryville	936	953	924	92.2	923.6	79.1 – 89.2	926.6 – 936.7	902	910
GW-989	Maryville	928	946	903	45	910.6	33.6 – 43.6	912-922	889	899
GY-020	Maryville	927	950	910	64	928.4	53.8 – 62.8	929.6 – 939.6	892	902
MW-1	Maryville	940.4	tbd	920	37.5	938.2	32 -37**	938.7 – 943.7	902	918
MW-2	Maryville	931.2	tbd	912	37.5	929	32 -37**	929.5 – 934.5	895	906
MW-3	Maryville	926.0	tbd	904	45	922.6	47-52**	923.1 – 928.1	890	900

*15-ft separation between bottom of emplaced waste and the seasonal high groundwater table

**Depth below GWFD cover surface

Fm = formation

tbd = to be determined

8.3 PRECIPITATION MONITORING

The existing Y-12 meteorological tower at the Spallation Neutron Facility will continue to be used to monitor precipitation for the EMDF Project. This meteorological tower is located across Bear Creek Valley from EMDF. The precipitation data from this location will be used to determine the impact to groundwater from precipitation during the GWFD and will be used to determine if the demonstration period is or is not representative of historical rainfall.

8.4 INTERPRETATION OF MONITORING RESULTS

Based on the comparison between existing potentiometric data monitoring during wetter periods and the preliminary design elevation of the geologic buffer, piezometers demonstrate groundwater below the elevation of the geologic buffer, except in the knoll area. Piezometers in the knoll area currently demonstrate mounding in groundwater, with elevations above the bottom of the proposed geologic buffer.

The piezometers with either have current (pre-construction) wet season groundwater elevations/potentiometric surfaces higher than the base of the geologic buffer or are anticipated to have current (pre-construction) wet season groundwater elevations/potentiometric surfaces higher than the base of the geologic buffer. These piezometers are shown in Fig. 15 and will be used to determine the landfill design that will meet the RAO to maintain a 15-ft separation between the bottom of emplaced wastes and the seasonal high water table of the uppermost unconfined aquifer, which includes 5 ft of liner system and 10 ft of geologic buffer, consistent with TDEC 0400-11-01-.04(4)(a)(2), *Solid Waste Processing and Disposal*, “Specific Requirements for Class I, II, III, and IV Disposal Facilities:

- GW-983, high point of knoll
- GW-989, southern part of knoll area
- GY-020, south of GW-983 on knoll
- New piezometer MW-1, lower on the knoll to the west
- New piezometer MW-2, lower on the knoll between GW-983 and GY-020
- New piezometer MW-3, lower on the knoll to the southeast

The objective of the GWFD is to determine the seasonal high groundwater table. Therefore, the median monthly groundwater elevations measured in the wettest month (the month with the highest groundwater elevations) will be used to determine the seasonal high groundwater elevation based on the 80th percentile of groundwater elevations. While the highest groundwater levels typically occur in February, during the GWFD, the wet season month with the highest groundwater levels will be used for the median seasonal high groundwater elevation. This month may not be February.

As described in the ROD, if deemed necessary due to a demonstration period that is not representative of historical rainfall (significantly wetter or drier), an adjustment may be warranted. The determination of the method used to calculate the adjustments will be completed by an FFA triparty technical team. The adjustment process will include comparison of rainfall amount, duration, and frequency to historical measurements, and responses measured in surrounding piezometers to historical groundwater information. The representative criteria and adjustment method will be determined by the FFA triparty technical team. The agreed-upon approach will be documented as an erratum to this RDWP/RAWP.

Please note, although not required to determine impacts from EMDF construction on the knoll area water levels, the other piezometers in the EMDF area will continue to be monitored, as possible and practical. These will provide comparison data for consideration of seasonal variation outside the influence of the GWFD, if necessary.

8.5 PERFORMANCE/ACCEPTANCE CRITERIA

Groundwater elevations will be collected and analyzed per *URS / CH2M Oak Ridge LLC Quality Assurance Plan for Environmental Characterization and Monitoring, Oak Ridge, Tennessee* (UCOR-4189; QA Plan).

8.6 REPORTING OF MONITORING RESULTS

Monitoring results will be provided to the project team as these are available, and the monitoring results from each wet season and associated evaluation/interpretation will be provided in a Technical Memorandum (TM) after the first wet season monitoring period and in a follow-on TM after the second wet season monitoring period. These results will also be included in the landfill RDR. DOE will accept comments on the TMs, but because these are not primary FFA documents, revisions to the TMs are not planned.

9. SCHEDULE

As noted in Sect. 2.2, construction for the 7B Borrow Area is expected to begin in fall 2023. The GWFD construction activities are currently planned to begin in February 2024, and are planned to be completed in fall 2024, in time to monitor the 2024/2025 wet season.

Following construction of the GWFD cover, monitoring will be performed for one wet season to determine the expected post-landfill-construction seasonal high groundwater elevation in the knoll area. Following the first wet season, final landfill design will begin, based on the monitoring data. Monitoring will continue through the second wet season to obtain additional information and will refine the design, if needed.

Key activities for the GWFD are shown below in Fig. 16.

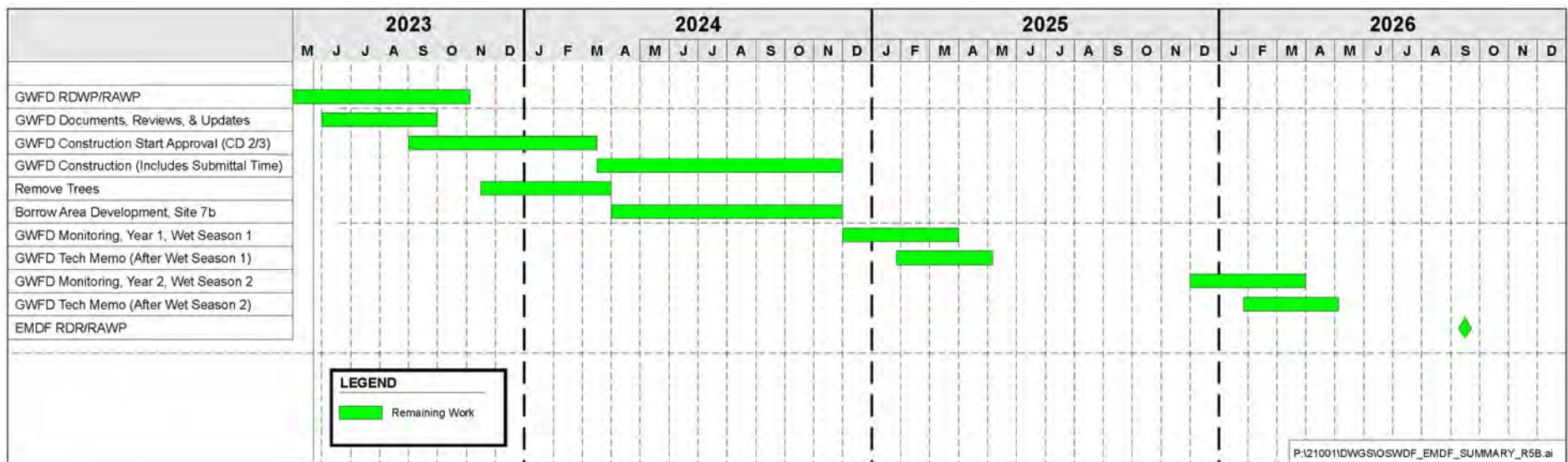

Fig. 16. GWDF key activities.

10. REFERENCES

- ASCE 7-16. *Minimum Design Loads and Associated Criteria for Buildings and Other Structures*, June 2017, American Society of Civil Engineers, Reston, VA.
- CRA 2018. *Phase I Archaeological Survey of the Proposed Environmental Management Disposal Facility in Central Bear Creek Valley, Roane County, Tennessee*, Contract Publication Series 18-139, June 2018, Cultural Resource Analysts, Inc., Lexington, KY.
- DOE/OR/01-2695&D2/R1. *Proposed Plan for the Disposal of Oak Ridge Reservation Comprehensive Environmental Response, Compensation, and Liability Act (CERCLA) Waste*, September 2018, U.S. Department of Energy, Oak Ridge Office of Environmental Management, Oak Ridge, TN.
- DOE/OR/01-2794&D2/R2. *Record of Decision for Comprehensive Environmental Response, Compensation, and Liability Act Oak Ridge Reservation Waste Disposal at the Environmental Management Disposal Facility, Oak Ridge, Tennessee*, September 2022.
- DOE/OR/01-2819&D1. *Technical Memorandum #2, Environmental Management Disposal Facility, Phase I Monitoring, Oak Ridge, Tennessee*, May 2019.
- ICC 2018. *International Building Code (IBC)*, 2018, International Code Council, Washington, D.C.
- Koerner, R. M. and T. Y. Soong 2005. “Analysis and Design of Veneer Cover Soils,” *Geosynthetics International*, Vol. 12, No. 1, p. 22, Scotland.
- ORNL/TM-2015/248. *Bat Species Distribution on the Oak Ridge Reservation*, October 2015, Oak Ridge National Laboratory, Oak Ridge, TN.
- ORNL/TM-2018-515. *Natural Resource Assessment for the Proposed Environmental Management Disposal Facility (EMDF), Oak Ridge, Tennessee*, June 2018.
- Robinson and Johnson 1995. *Results of a Seepage Investigation at Bear Creek Valley, Oak Ridge, Tennessee January – September 1994*, USGS Open-File Report 95-459, U. S. Geological Survey, Nashville, TN.
- SPG-00000-A005. *Standard Specification for Well Drilling, Installation, and Abandonment*, latest revision, United Cleanup Oak Ridge, Oak Ridge, TN
- TDEC 0400-11-01-.04. *Solid Waste Processing and Disposal*, “Specific Requirements for Class I, II, III, and IV Disposal Facilities, latest revision, Tennessee Department of Environment and Conservation, Nashville, TN.
- TDEC 1994. *Earthquake Evaluation Guidance Document*, Tennessee Department of Environment and Conservation, Nashville, TN.
- TDEC 2012. *Tennessee Erosion and Sediment Control Handbook*, latest edition, Tennessee Department of Environment and Conservation, Nashville, TN.

UCOR-4189. *URS / CH2M Oak Ridge LLC Quality Assurance Plan for Environmental Characterization and Monitoring, Oak Ridge, Tennessee*, latest revision, United Cleanup Oak Ridge LLC, Oak Ridge, TN

———UCOR-5620. *Stormwater Management Requirements for Groundwater Field Demonstration for the Onsite Waste Disposal Facility, Oak Ridge, Tennessee*, latest revision (in progress).

USACE 2003. *Slope Stability*, October 2003, Engineer Manual EM 1110-2-1902, U.S. Army Corps of Engineers, Nashville, TN.

USBR 2011. *Embankment Dams*, November 2011, Design Standards No. 13, U.S. Bureau of Reclamation, Department of the Interior, Washington, D.C.

**APPENDIX A.
SENSITIVE RESOURCES**

This page intentionally left blank.

A.1 GROUNDWATER FIELD DEMONSTRATION SCOPE

The Groundwater Field Demonstration (GWFD) is designed to approximate the elimination of recharge to groundwater from construction of the Environmental Management Disposal Facility (EMDF) landfill in the knoll area. The key elements are:

- 1) Upgradient stormflow interceptor channel to reduce lateral recharge into the area
- 2) Temporary cover system designed to approximate the conditions of the final landfill liner system configuration, such that infiltration and recharge are cut off to the GWFD footprint
- 3) Stormwater controls to divert runoff from the cover away from the GWFD area
- 4) Development of the 7B Borrow Area to provide fill material for construction of the GWFD and for the balance of landfill.

The GWFD will require clearing of the northern part of the landfill area and the support areas.

The major EMDF components are shown on Fig. A.1.

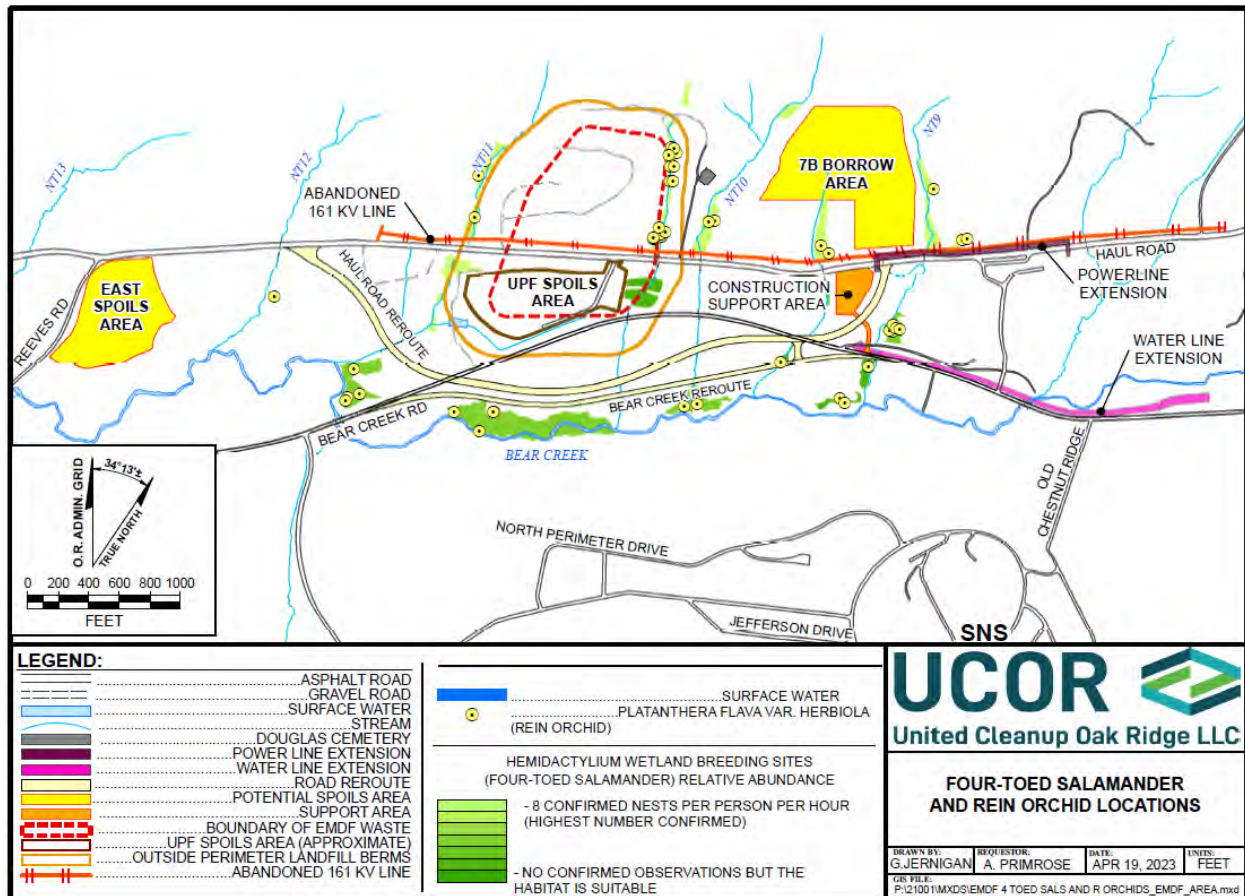

Fig. A.1. Location of EMDF activities.

This page intentionally left blank.

A.2 ECOLOGICAL RESOURCES

A detailed natural resource evaluation and wetland delineation study was performed over most of the EMDF footprint (Fig. A.2). The evaluation is documented in *Natural Resource Assessment for the Proposed Environmental Management Disposal Facility (EMDF), Oak Ridge, Tennessee* (ORNL/TM-2018-515). Additional evaluations in 2022-2023 covered the remaining small areas:

- Westernmost extension of Haul Road
- Water line extension outside of the EMDF footprint and along Bear Creek Road
- Power line extension outside of the EMDF footprint and along Haul Road
- Removal of the abandoned power line outside of the EMDF footprint along Haul Road
- Spoils Areas

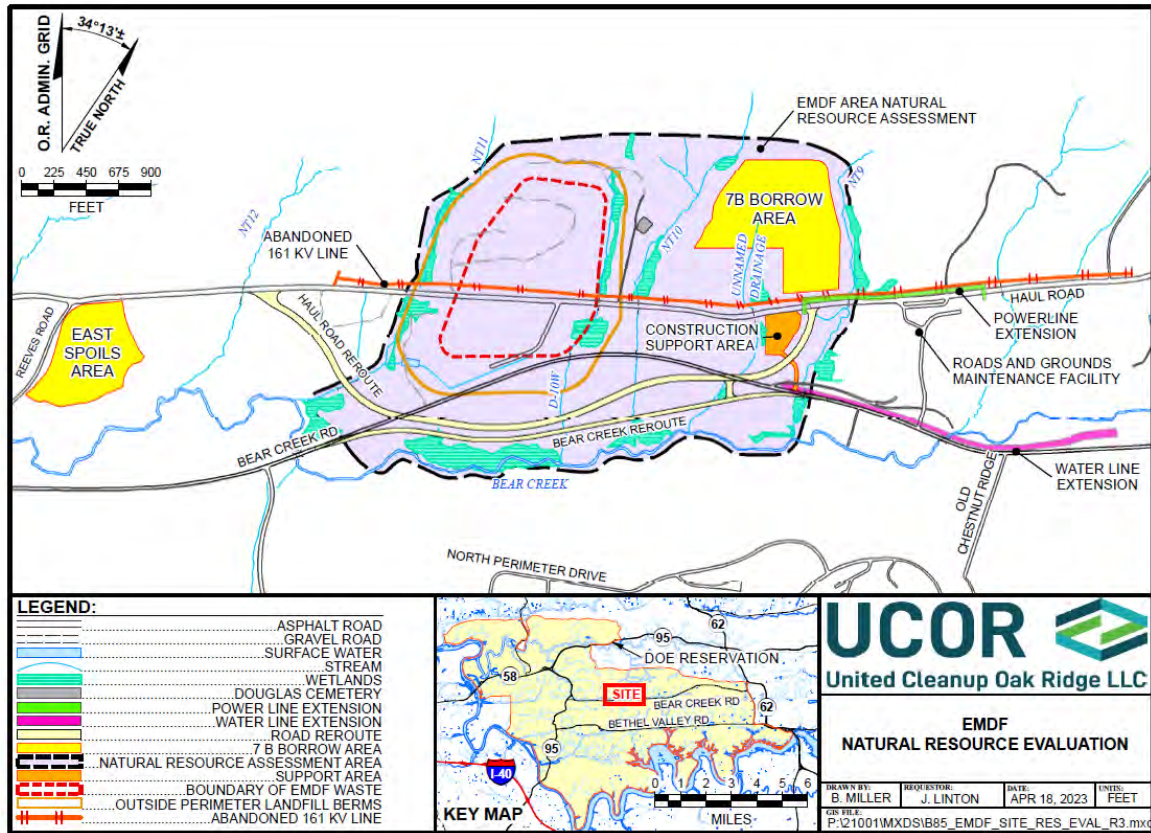

Fig. A.2. Location of natural resource evaluation and EMDF scope areas.

The natural resource assessment included wetland delineations, stream determinations, timber assessments, and rare species surveys. In addition, walkdowns were conducted in the fall/winter of 2022 to evaluate the extension of Haul Road that was not covered by the initial natural resource evaluation (Fig. A.2). The results of the natural resource evaluation are summarized below.

Wetland delineations: Potential wetlands were evaluated for the entire EMDF Project site relative to the dominance of wetland vegetation, soils, and hydrological characteristics. Seventeen wetlands, including

one created wetland, were identified within the entire EMDF study area, covering 11.813 acres. The GWFD and balance of landfill scope was designed and will be constructed to minimize impacts to these wetlands. However, based on re-evaluation of the impacts to GWFD activities based on newly provided design information, it is anticipated that approximately 5.1 acres of wetland will be directly impacted from direct overlap with construction, with a minimum expected loss of 6.03 acres from both overlap with construction and associated changes.

It is not yet certain what the maximum expected loss will be, but the impacts were estimated using the clearing limits for the EMDF project plus a buffer as a best management practice. Based on this larger area, it was estimated that 6.03 to 11.8 acres could be disrupted and/or eliminated as a result of EMDF activities. (Fig. A.1). Table A.1 provides the conservative wetland acreage in the EMDF area and the acreage impacted along with comments on the potential impacts. Direct impacts include a wetland area that is removed (filled with soil or a change in water flow). Indirect impacts are the result of changes in stream hydrology, runoff, percolation, water temperature, or vegetation cover. Note, wetlands are named first by the tributary in which they occur, and then are assigned a letter based on their relative position. The impacts will be refined over time as the EMDF design is finalized.

The most impacted wetland is in Drainage (D)-10W. The wetland from the saddle from the upgradient stormflow interceptor channel to Bear Creek Road (D10W-B) will be completely removed by GWFD and balance of landfill construction activities and will be replaced with structural fill material. This results in a loss of almost 0.8 acres of wetlands. D10W-A is located north of the upgradient stormflow interceptor channel and is expected to be impacted if the downgradient area of the wetland is disrupted or removed during GWFD construction.

Uranium Processing Facility (UPF)-11, the engineered wetlands constructed along D-10W as mitigation for the Y-12 National Security Site UPF, will remain during the GWFD activities, but will be removed by the balance of landfill construction for a loss of 0.81 acres of wetland.

The wetlands in North Tributary (NT)-11 will be impacted by the construction of GWFD and balance of landfill berms. The NT-11 course was maintained as much as possible, but the northern portion was modified slightly to maintain a stable slope for the GWFD activities and follow-on EMDF construction. The western bank of NT-11 was maintained, with neither cut nor fill required. NT11-A wetlands west of NT-11 are planned to be protected and maintained as much as practical during construction activities, but impacts are expected. Wetland NT11-B will be impacted by GWFD activities, resulting in a projected loss of between 0.68 to 0.72 acres of wetlands from construction of the NT-11 interceptor ditch to the sediment basin and the landfill's western berm. NT11-C is also impacted by construction of the landfill, with a projected loss of 0.05 to 1.065 acres.

Wetlands in NT-10 will not be directly impacted except for NT10-A, however, indirect impacts are expected because of the increased flow in this drainage.

No construction will occur in the NT-9 drainage, except for replacement of a culvert at NT-9C. The access road to the Construction Support Area was rerouted during design with guidance from the Oak Ridge National Laboratory (ORNL) Natural Resources to avoid direct impacts. However, there will be direct and indirect impacts from construction of the Site 7B Borrow Area.

Table A.1. EMDF wetlands and impacted acreage

Wetland Name	Wetland size (ac.)	Area directly impacted (ac.)			Additional indirect impacts expected to any remaining area	Comments
		Direct Overlap	Minimum Expected Loss*	Maximum Expected Loss		
BCK-A	3.363	0.233	0.233	unknown	✓	Bear Creek Rd reroute clips north side of wetland and feeders clipped and/or culverted
D10W-A	0.136	0.076	0.076	0.136	✓	Mostly removed by GWFD construction
D10W-B	0.780	0.780	0.780	0.780	NA, complete loss expected	Removed by GWFD construction
NT10-A	0.188	0.000	0.000	unknown	✓	Probable impacts from flow diversion
NT10-B	0.630	0.357	0.630	0.630	NA, complete loss expected	Partially removed with additional impacts from flow diversion; remaining area encircled by construction limits
NT10-C	0.680	0.097	0.680	unknown	✓	Direct impact from culvert placement for ESP road reroutes; upstream effects could lead to complete loss
NT11-A	0.774	0.732	0.774	0.774	NA, complete loss expected	Mostly removed by GWFD construction.
NT11-B	0.716	0.684	0.716	0.716	NA, complete loss expected	Removed by GWFD and landfill construction
NT11-C	1.065	0.052	0.052	unknown	✓	Direct impacts during initial clearing, culvert replacement, and road reroutes; upstream and downstream impacts
NT9-A	0.923	0.269	0.269	unknown	✓	Direct impacts from landfill construction
NT9-B	0.415	0.055	0.055	unknown	✓	Direct impacts during initial clearing and later culvert replacement and road reroutes
NT9-C	0.281	0.102	0.102	unknown	✓	Clipped by clearing and culvert replacement for ESP road reroutes
NT9-D	0.197	0.000	0.000	unknown	✓	Possible impacts from upstream activities
UPF W11	0.807	0.807	0.807	0.807	NA, complete loss expected	Removed by landfill
UT-A	0.661	0.660	0.661	0.661	NA, complete loss expected	Removed by landfill
UT-B	0.089	0.089	0.089	0.089	NA, complete loss expected	Removed by landfill
UT-C	0.104	0.104	0.104	0.104	NA, complete loss expected	Removed
Spoils	0.005	0.005	0.005	0.005	NA, complete loss expected	Removed; Small four-toed salamander breeding site discovered in spring 2023
Totals	11.813	5.101	6.032	6.032 – 11.813		Maximum possible direct + indirect impact equal to total wetland acreage

* Direct overlap with construction and associated changes.

D = Drainage ESP = Early Site Preparation NT = North Tributary

Stream surveys: Five tributary streams are present in the EMDF area: NT-9, NT-10, D-10W, NT-11, and an unnamed tributary between NT-9 and NT-10 (Fig. A.2). All are considered first or second order streams characterized by low flows during non-rain events, shallow pools, and riffles. There are multiple road crossings on these streams, including Bear Creek Road, Haul Road, and some historical roads/culverts across the streams. Many of these road crossings present physical barriers for upstream migration of aquatic fauna, in particular fish, by creating large elevation changes in the stream channel just below the culverts. In addition, the upstream side of these culverts often create wetlands with meandering stream channels filled with sediments, not typical of other higher gradient streams found across the Oak Ridge Reservation (ORR).

Early Site Preparation (ESP) construction activities will require installation of approximately 900 ft of culverts. Existing culverts were used wherever possible, including the existing culverts and bridge used where Bear Creek Road crosses over Bear Creek.

The stream channel for NT-9 will not be changed, except for replacement of an undersized culvert where NT-9 crosses under Bear Creek Road (Fig. A.3)

A section of the D-10W channel will be rerouted to NT-10. The upper channel of D-10W will remain intact; however, the channel segment adjacent to EMDF disposal cells will be rerouted to NT-10 (Fig. A.4). The lower portion of D-10W channel will remain, but with reduced stream flow. Culverts will be placed in the lower section of D-10W to support Haul Road and Bear Creek Road reroutes during ESP activities (Fig. A.3). This results in removal of approximately 1657 ft of the D-10W channel.

The stream channel for NT-10 will not be changed. However, rerouting a portion of D-10W flow to NT-10 increases flow in this drainage. Culverts will be placed in the lower section of NT-10 to support Haul Road and Bear Creek Road reroutes during ESP activities (Fig. A.3)

The impacts to streams in the EMDF area were calculated based on the clearing limits for the EMDF project plus a buffer as a best management practice. Overall, the minimum length of stream with direct impact/overlap with EMDF was estimated at 11,033 ft. The minimum length of stream with expected either temporary or permanent direct impacts was estimated at 29,609 ft. These impacts include temporary physiochemical impacts and includes some portions of Bear Creek immediately adjacent to EMDF. As with the wetlands, these impacts are planned to be minimized during the design and construction phases of the EMDF, with a revised number provided when the impacts are better known.

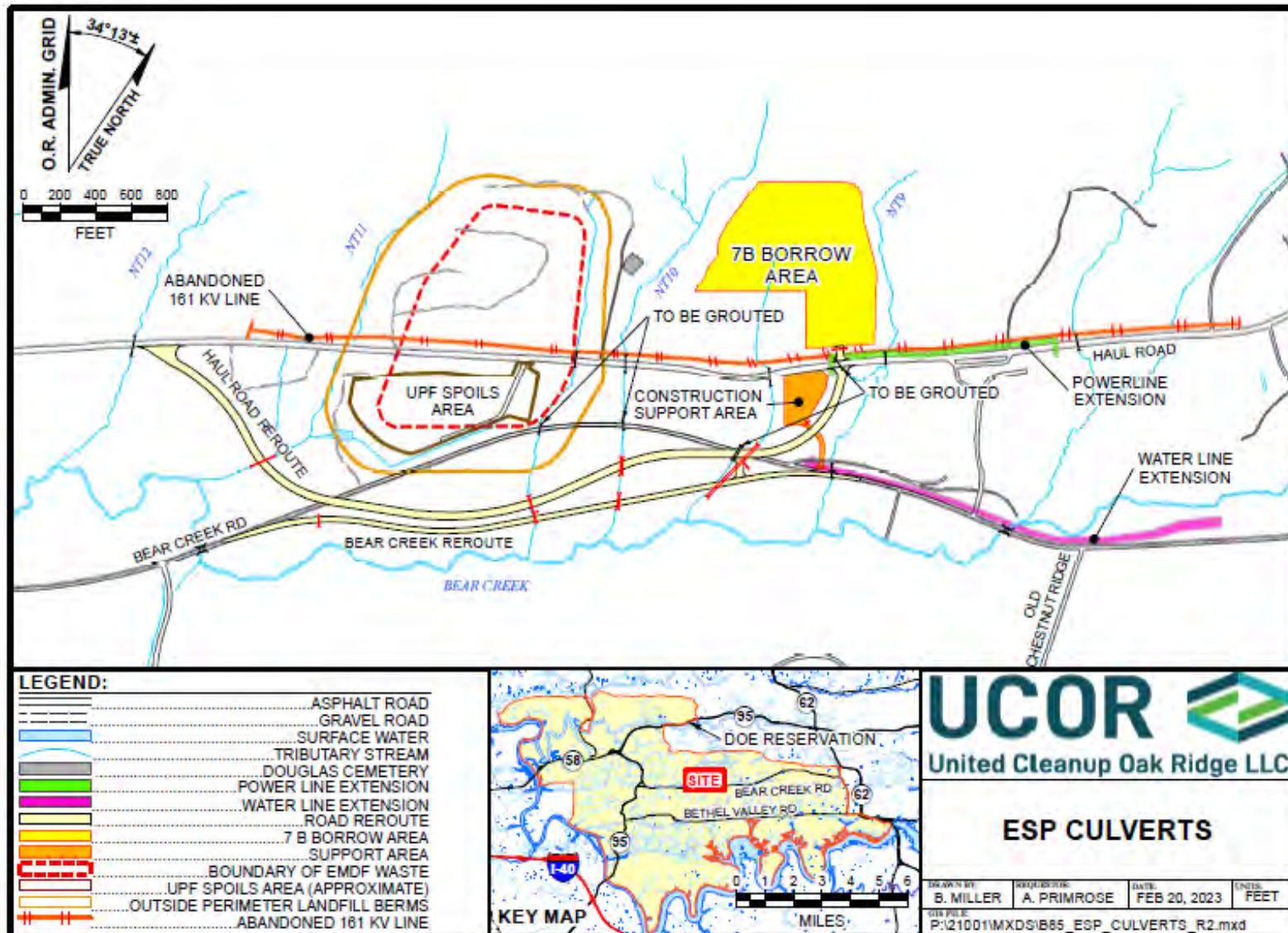

Fig. A.3. Culverts added or modified for ESP activities.

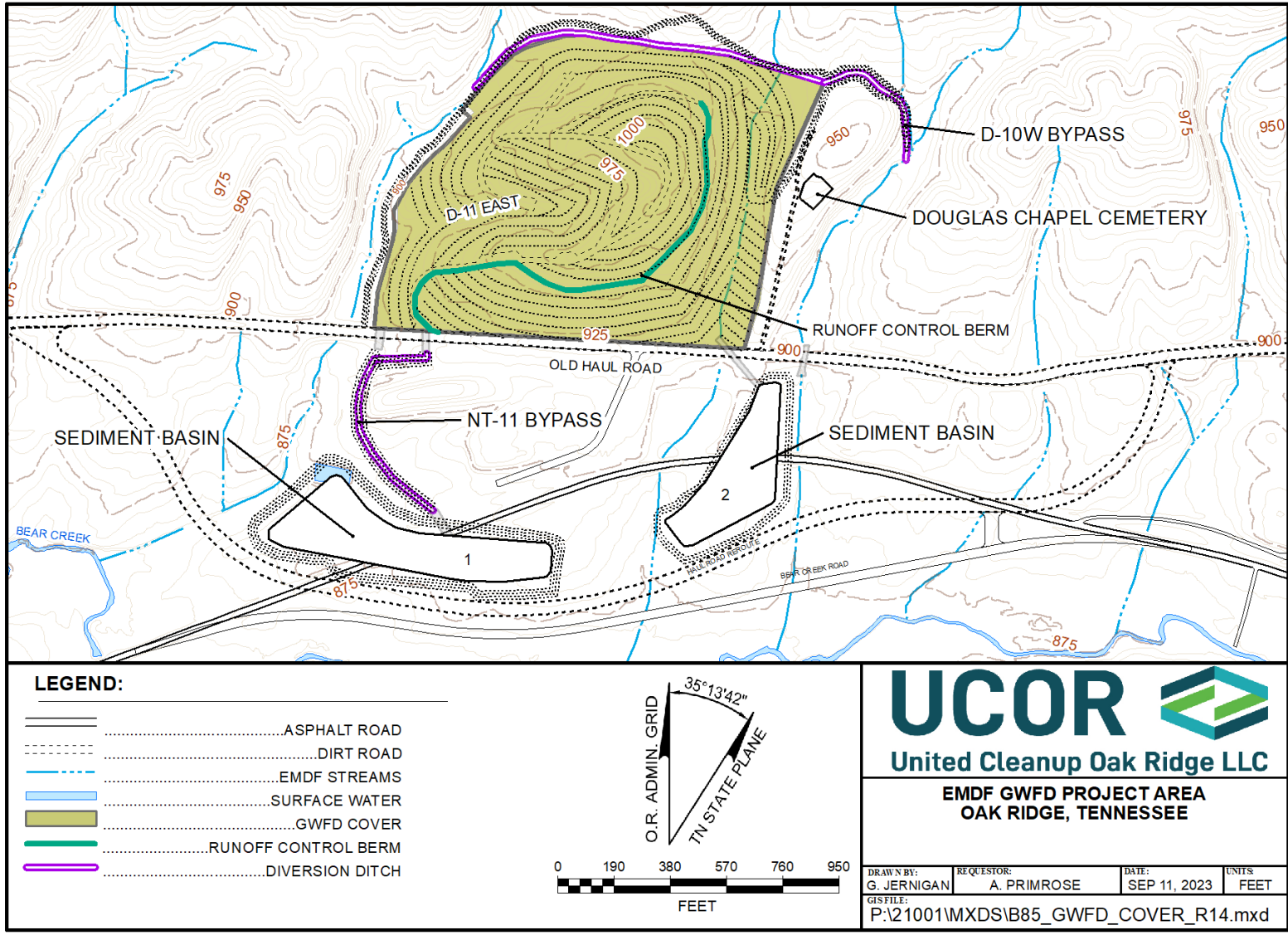

Fig. A.4. GWFD Project layout and stream modifications.

Stream flow in the upper reach of NT-11 adjacent to the GWFD area will be modified to place the temporary cover system, although the stream will remain in its existing channel as much as possible. NT-11 upper stream channel modifications may increase in this same area during construction of the berms for the EMDF. Approximately 371 ft of NT-11 channel will be removed/modified by GWFD and landfill construction.

NT-12 will not be modified by EMDF construction activities. The unnamed tributary will be modified by placing culverts along the lower stretch to support Haul Road and Bear Creek Road reroutes during ESP (Fig. A.3). Stream flow in the unnamed tributary may increase due to increased run-off from the 7b Borrow Area. Approximately 730 ft of the unnamed tributary may be removed/modified by landfill construction.

Sediment controls will be placed to prevent and control sediment release to streams, drainages, and wetlands. Erosion controls will include placing a double row of silt fences between the Construction Support Area and the drainages/wetlands. Sediment release will also be controlled by placing geotextile and aggregate over the area and controlling drainage by use of temporary culverts.

The Bear Creek watershed is home to a strong population of Tennessee dace, the only fish on the ORR listed as “in need of management” by the Tennessee Wildlife Resources Agency. No Tennessee dace were observed in the tributary streams at the EMDF site during the fish surveys; however, EMDF stormwater controls will protect Tennessee dace in streams that may be impacted by EMDF construction activities. Prior to performing construction activities, streams will be walked down and sensitive resources, including Tennessee dace, will be relocated.

Timber assessments: As described in ORNL/TM-2018-515, the GWFD area and the balance of landfill outside of the ESP activities are primarily located in hardwood forest, potentially around 60+ years old. Trees with a diameter at breast height (dbh) greater than 10 in. represent approximately 52% of the total forested area. These trees are primarily tulip poplar (~23%), white oak (~16%), red maple (~14%), and sweet gum (~9%). Trees with dbh between 2 and 10 in. are primarily six species: red maple (15.3%), sweet gum (13.9%), loblolly pine (13.5%), tulip poplar (10.7%), sourwood (8.2%), and dogwood (6.0%). Figure A.5 illustrates the canopy height for forested parts of EMDF.

North of Bear Creek Road, the trees average 508 stems per acre of trees greater than 2 in. dbh with about 48 trees 10 in. dbh or larger per acre. In the 161 acres surveyed for the EMDF Project, 10 trees were identified with a diameter greater to or equal to 30 in. dbh measured at the sample points (tally trees). The tree identified with the greatest dbh in the area was a 38-in. dbh chestnut oak. Of the 10 tally trees identified, six were oak trees.

The EMDF area south of Bear Creek Road was almost entirely subject to timber harvesting during a southern pine beetle outbreak in 2000 and is primarily dense, loblolly pine. Much of the GWFD and balance of landfill areas consists of potentially marketable timber.

Timber is a U.S. Department of Energy (DOE) real estate asset and will be dispositioned as an asset through a standing timber sale agreement. Non-marketable woody debris is anticipated to be chipped and used for mulch throughout the EMDF Project.

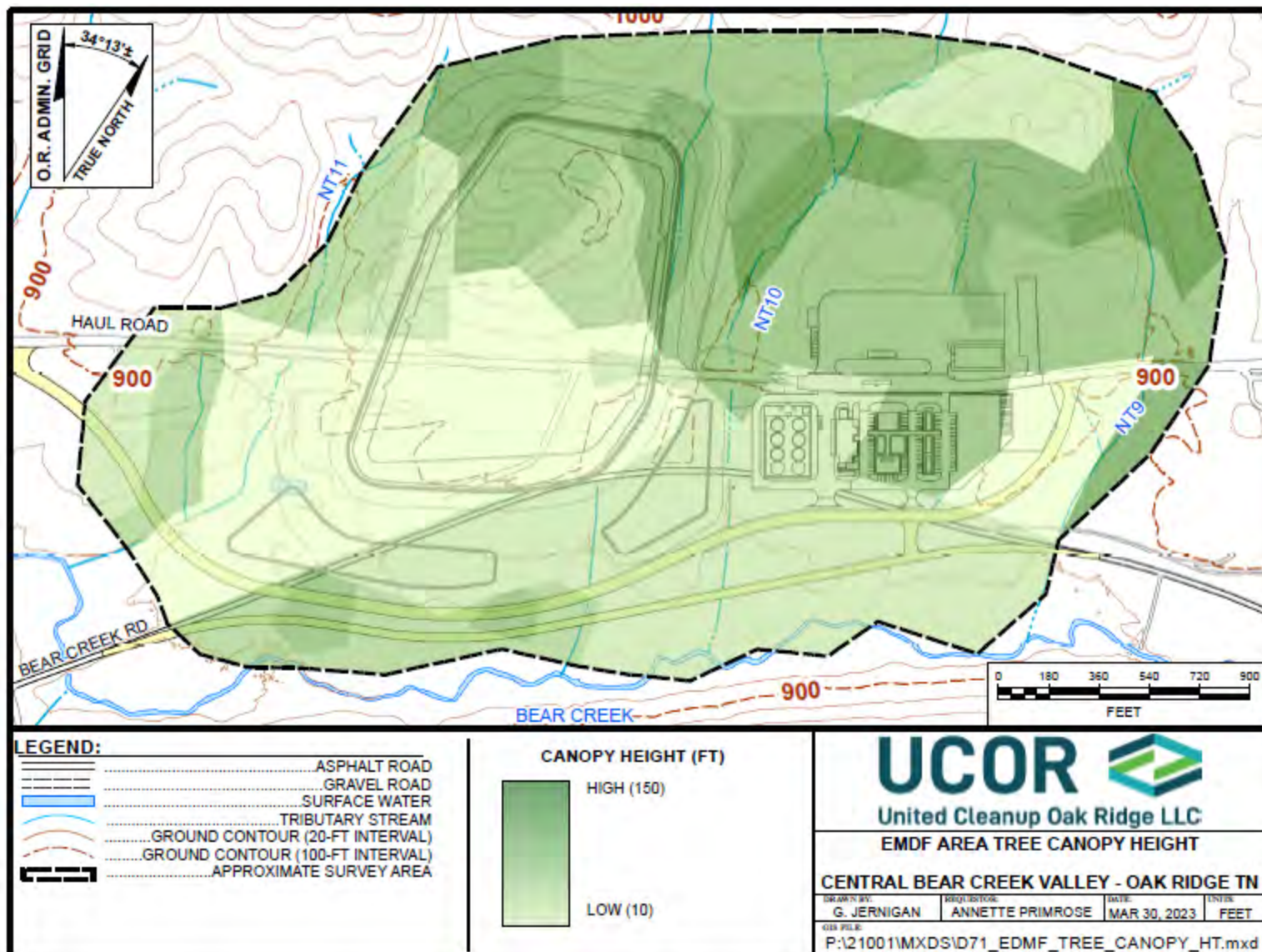

Fig. A.5. Forest canopy height of EMDF and vicinity (from ORNL/TM-2018-515).

Rare species surveys: Previous investigations to identify threatened and endangered species on the ORR (ORNL/TM-2015/248), *Bat Species Distribution on the Oak Ridge Reservation*, in general, have confirmed the presence of Indiana bats, gray bats, and the northern long-eared bat, all federally listed endangered species; tricolored bats, which are proposed for federal listing; and little brown bats, which are under consideration for federal listing. Results of the bat acoustic surveys indicated that forested portions of the EMDF Project area are used as summer habitat by state- and federally listed bat species. One federally listed endangered species (gray bat) may forage within the site boundaries, but does not roost in these areas. Consultation with the U.S. Fish and Wildlife Service (USF&WS) will be conducted in 2023 and is expected to be documented in the D2 Remedial Design Work Plan (RDWP)/Remedial Action Work Plan (RAWP) or an addendum.

Acoustic surveys conducted in 2018 also indicate the presence of two federally listed endangered bat species: Indiana bat and northern long-eared bat (ORNL/TM-2018-515). Recorded call numbers for these two species were very low; however, presence cannot be ruled out. Presence of little brown bat and tricolored bat are indicated by the high number of acoustic calls recorded throughout the EMDF Project area. A survey for potential suitable roost trees for forest-dwelling bat species was conducted in March 2023. Results show that higher elevations on the north facing slope of Pine Ridge within the EMDF Project area have abundant potential roost trees with peeling bark and snags with peeling bark and protected crevices. White oak is a dominant species in this location (ORNL/TM-2018-515).

Much of the GWFD and balance of landfill activities will take place in areas forested with mature hardwoods, including preferred roosting trees for bats. Additional evaluation will be performed in 2023 to evaluate for the presence of potential roosts for bats, including the tricolored bats that may roost in road culverts and riparian buffer zones. Potential roost areas will be identified prior to the start of GWFD activities.

Other threatened and endangered species surveys were conducted by ORNL in 2018 (ORNL/TM-2018-515). The tubercled rein orchid (*Platanthera flava* var. *herbiola*), listed as threatened on the Tennessee Rare Plant List, was found in wetlands within the study area, particularly in wetlands along the NT-9, NT-10, and D-10W streams. D-10W and NT-9 both have large populations of rein orchids (Fig. A.6). Two other plant species of interest found were the American ginseng and pink lady's slipper, which are considered of concern because of commercial harvest.

The four-toed salamander and the Wood Thrush (state-listed as In-Need-of-Management) occur throughout forested portions of the study area. Wetlands and drainages within the area were found to contain the highest densities of four-toed salamander breeding sites known on the ORR (Fig. A.6).

No federally listed threatened or endangered bird species were noted during the surveys; however, certain species recorded during the surveys have other state and/or federal management designations. These include dozens of species of birds protected under the Migratory Bird Treaty Act and/or are considered Birds of Conservation Concern by the USF&WS. The site is on the southern edge of the largest area of contiguous interior forest on the ORR that supports rare bird species. These rare species are not typically found in more fragmented habitats (ORNL/TM-2018-515).

The approach to minimize impacts to rare species is as follows:

- The GWFD and landfill designs avoided areas with rare species to the extent practical. However, impacts to four-toed salamanders and tubercled rein orchids are unavoidable (Fig. A.6). ORNL Natural Resources subject matter experts are coordinating the relocation of both salamanders and tubercled rein orchids to nearby, similar habitats in 2023 to minimize the impacts to these populations.

- ORNL Natural Resources subject matter experts will identify potential bat-roosting trees in the GWFD and balance of landfill areas. These potential bat-roosting trees will be removed prior to the start of field work, and prior to the start of the bat-foraging season, expected to be March 31, as determined in consultation with the USF&WS.
- Potential roost areas for tri-colored bats will be identified in the GWFD and balance of landfill areas. Prior to the start of field activities, candidate roosting sites will be fitted with one-way devices to allow bats to exit but not return.
- Fish and aquatic wildlife sweeps and relocations will be conducted prior to construction in D-10W and NT-11, and prior to culvert placement, grouting or replacement, given the possible presence of crayfish and four-toed salamanders in all drainages. Although Tennessee dace have not been detected in the EMDF drainages, these will be included in the sweeps and relocated if present.

In accordance with Tenn. Comp. R. & Regs. § 0400-40-07-.04(7)(a), mitigation planning for both the GWFD and balance of landfill areas is in progress. The planning process will include any mitigation required for the ESP activities as part of the overall EMDF mitigation effort. The required mitigation will be documented in an addendum.

Areas with similar stream and wetland ecosystems in lower Bear Creek Valley are being considered for preservation. Other areas on the ORR are also being evaluated for specific mitigation purposes.

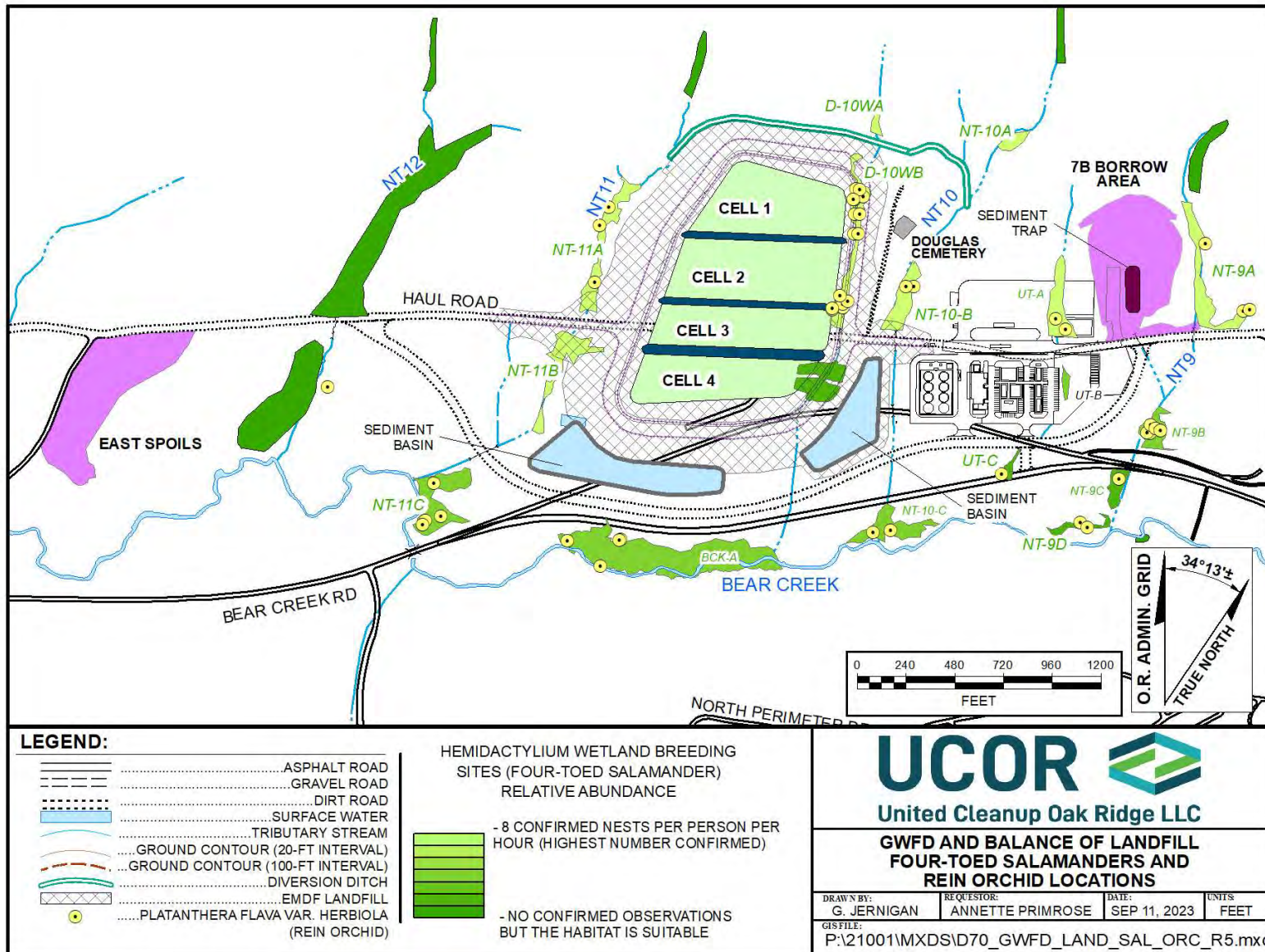

Fig. A.6. EMDF Project layout with current wetlands, locations of rein orchids and four-toed salamanders.

This page intentionally left blank.

A.3 CULTURAL RESOURCES

The Douglas Chapel Cemetery and four historical home site/structures are present near the EMDF site (Cultural Resource Analysts, Inc. 2018, *Phase I Archaeological Survey of the Proposed Environmental Management Disposal Facility in Central Bear Creek Valley, Roane County, Tennessee*). Douglas Chapel Cemetery is located on the knoll between NT-10 and D-10W. DOE intends to avoid and preserve the Douglas Chapel Cemetery, as well as maintain access to the cemetery for visitors.

The four home sites were demolished when the federal government purchased the land for the Manhattan Project. A prehistoric habitation was located near Bear Creek where lithic flakes were found, an indication of prehistoric tool production. All the sites were highly disturbed and appeared to contain no buried cultural deposits. The sites were not recommended for inclusion in the National Register of Historic Places.

No historically significant sites are located within the GWFD area. The Douglas Chapel Cemetery is located nearby, but will not be disturbed by either GWFD or landfill construction activities (Fig. A.6).

This page intentionally left blank.

A.4 GWFD/BALANCE OF LANDFILL EVALUATION OF IMPACTS TO SENSITIVE RESOURCES

While the design minimized impacts to sensitive resources as practical, construction of the GWFD and balance of landfill will impact streams, wetlands, and sensitive species (Fig. A.6). Approximately 900 ft of culvert will be placed in streams and wet weather conveyances, D-10W will be rerouted, up to 6.03 acres of wetlands will be destroyed by overlap with construction activities and associated changes, and sensitive species, primarily tubercled rein orchids and four-toed salamanders will be displaced. Roosting and foraging habitat for several species of bats will be reduced, including threatened or endangered bat species.

Measures to Reduce Impacts to Sensitive Resources

Potential bat-roosting trees will be identified and removed in advance of the foraging season. The remaining trees will be offered for timber sales through the DOE Real Estate Office. Trees that are not marketable are expected to be chipped and used as mulch throughout the project site.

ORNL Natural Resources subject matter experts are coordinating the relocation of both salamanders and tubercled rein orchids to nearby, similar habitats in 2023 to minimize the impacts to these populations.

Fish and aquatic wildlife sweeps and relocations will be conducted prior to construction in D-10W and NT-11, and prior to culvert placement, grouting, or replacement, given the possible presence of crayfish and four-toed salamanders in all drainages. Although Tennessee dace have not been detected in the EMDF drainages, these will be included in the sweeps and relocated if present.

Erosion and sediment controls will be placed to minimize impacts to streams and wetlands. The *Stormwater Management Requirements for Groundwater Field Demonstration for the Onsite Waste Disposal Facility, Oak Ridge, Tennessee* (UCOR-5620, in progress) supports the GWFD clearing and grading activities and presents erosion and sediment control best management practices (BMPs). Sediment and erosion control BMPs anticipated to be incorporated include:

- Minimizing disturbed areas
- Controlling stormwater runoff
- Stabilizing disturbed soils as soon as practical
- Protecting slopes and storm inlets downgradient from the work area
- Establishing perimeter controls
- Retaining sediment onsite

Sediment/erosion control measures will be designed in accordance with the guidance presented in the *Tennessee Erosion and Sediment Control Handbook* (Tennessee Department of Environment and Conservation 2012).

GWFD construction activities are to be phased to minimize the amount to disturbed areas exposed at any given time. Perimeter runoff controls, including silt fences, straw wattles, and construction exits will be installed prior to clearing and grubbing. Clearing, grubbing, stripping, and grading will only occur in designated construction areas where improvements are planned. Natural features and vegetative soil cover outside of the construction areas will be protected to avoid disturbance to trees or vegetative cover and to minimize soil erosion.

The following erosion and sediment control BMPs will be applied for the GWFD construction activities:

- Control of stormwater flowing onto and through project area
 - Straw wattles: serve as run-on diversion, runoff filtration, water velocity dissipation
 - Check dams: installed in swales and ditches to reduce velocity in channels and thereby reduce erosion
 - Diversion berm: divert rainwater away from the cut slopes and control stormwater flowing onto the project
- Stabilization of soils
 - Hydromulching: protect exposed soils
 - Seeding and straw mulch: lawn areas will be seeded and stabilized with straw or similar mulching material
 - Roadway gravel/road base: placed on all areas receiving vehicular traffic (access roads and staging areas)
- Protection of slopes
 - Erosion-control blankets: used to stabilize slopes in swales, cut slopes, and sediment basin
- Protection of storm drain inlets
 - Straw wattles: protection for storm drain inlets (catch basins) until permanent vegetation has been established
- Perimeter controls and sediment barriers
 - Silt fences: installed along the toe of fill slopes and around topsoil stockpiles
- Stabilized construction exits
 - Anti-tracking pads: installed at project egress locations to prevent the offsite transport of sediment by construction vehicles
- Dust control: use of a water truck to apply water to disturbed areas to control dust

Additional BMPs not presented here may be incorporated, as needed. Impacts to waterbodies will be minimized through implementation of BMPs.

Erosion and sedimentation control during construction will be through use of silt fences, inlet and outlet protection at culverts and catch basins, grass-lined and riprap-lined ditches, filter rings, and other erosion- and sedimentation-control measures. Erosion-control matting will be installed on slopes steeper than 4:1 and all ditches not lined with riprap. Straw wattles will be installed along the contour (across the slope) to intercept water running down a slope. Completed slopes, ditches, and other areas will be seeded and mulched within 15 days of completion of site grading.

Sediment basins will be placed for sediment control for both for the GWFD and the final landfill disposal cells. These sediment basins are expected to be placed in the vicinity of the existing Haul Road, which will be rerouted as part of the ESP activities for the EMDF landfill (Fig. A.6). An additional sediment trap will be placed for sediment control for the 7B Borrow Area.

Run-on to the GWFD from the cemetery hill east of the GWFD will be controlled by the stormflow interceptor channel that is located over the cover in the in-filled former D-10W channel and routed to discharge into the newly constructed Pond 2 south of the old Haul Road.

Stormwater runoff-control ditches and two culverts will direct runoff to a series of culverts, conveying stormwater flow under Haul Road. All runoff controls are designed to convey the 25-year, 24-hour storm with enough capacity to convey the 100-year, 24-hour storm event without overtopping.

Mitigation Requirements

Mitigation planning for the GWFD and balance of landfill is in progress. The planning process will include any mitigation required for the ESP activities as part of the overall EMDF mitigation effort. The required mitigation will be documented in the D2 GWFD RDWP/RAWP or addendum.

This page intentionally left blank.

A.5 SUMMARY

A natural resource survey of the EMDF site was conducted and identified sensitive resources (ORNL/TM-2018-515). While the design avoided these as much as practical, construction of the GWFD and balance of landfill will adversely and permanently impact streams, wetlands, and sensitive species as follows:

- Approximately 900 ft of culvert will be placed in streams and wet weather conveyances
- D-10W will be rerouted to NT-10
- Up to 5.1 acres of wetlands will be directly impacted from direct overlap with construction, with a minimum expected loss of 6.03 acres from both overlap with construction and associated changes.
- Sensitive species, including tubercled rein orchids and four-toed salamanders, will be displaced
- Roosting and foraging habitat for several species of bats will be reduced, including threatened or endangered bat species

The following approach will be taken to minimize damages:

Potential bat-roosting trees will be identified and removed in advance of the foraging season. The remaining trees will be offered for timber sales through the DOE Real Estate Office. Trees that are not marketable are expected to be chipped and used as mulch throughout the project site.

Salamanders and tubercled rein orchids will be relocated to nearby, similar habitats in 2023 to minimize the impacts to these populations.

Fish and aquatic wildlife sweeps and relocations will be conducted prior to construction in D-10W and NT-11, and prior to culvert placement, grouting, or replacement, given the possible presence of crayfish and four-toed salamanders in all drainages. Although Tennessee dace have not been detected in the EMDF drainages, these will be included in the sweeps and relocated if present.

Erosion and sediment controls will be placed to minimize impacts to streams and wetlands. The *Stormwater Management Requirements for Groundwater Field Demonstration for the Onsite Waste Disposal Facility, Oak Ridge, Tennessee* (UCOR-5620, in progress) supports the GWFD clearing and grading activities and presents erosion and sediment control BMPs. Sediment and erosion control BMPs anticipated to be incorporated include:

- Minimizing disturbed areas
- Controlling stormwater runoff
- Stabilizing disturbed soils as soon as practical
- Protecting slopes and storm inlets downgradient from the work area
- Establishing perimeter controls
- Retaining sediment onsite

Additional mitigation measures are in the planning stage and will be described in the D2 RDWP/RAWP or an addendum.

This page intentionally left blank.

**APPENDIX B.
GWFD APPLICABLE OR RELEVANT AND APPROPRIATE
REQUIREMENTS**

This page intentionally left blank.

Table B.1. Location-specific applicable or relevant and appropriate requirements for selected alternative

Location Resource	Requirements	Prerequisite	Citation
<i>Wetlands</i>			
<p>Presence of wetlands as defined in 10 <i>CFR</i> 1022.4</p>	<p>Incorporate wetland protection considerations into its planning, regulatory, and decision-making processes, and, to the extent practicable, minimize the destruction, loss, or degradation of wetlands; and preserve and enhance the natural and beneficial values of wetlands.</p> <p>Undertake a careful evaluation of the potential effects of any proposed wetland action.</p> <p>Avoid, to the extent possible, the long- and short-term adverse impacts associated with the destruction of and occupancy and modification of wetlands. Avoid direct and indirect development in a wetland wherever there is a practicable alternative.</p> <p>Identify, evaluate, and, as appropriate, implement alternative actions that may avoid or mitigate adverse wetland impacts.</p> <p>Project Description. This section shall describe the proposed action and shall include a map showing its location with respect to the floodplain and/or wetland. For actions located in a floodplain, the nature and extent of the flood hazard shall be described, including the nature and extent of hazards associated with any high-hazard areas.</p> <p>Floodplain or Wetland Impacts. This section shall discuss the positive and negative, direct and indirect, and long- and short-term effects of the proposed action on the floodplain and/or wetland. This section shall include impacts on the natural and beneficial floodplain and wetland values (§ 1022.4) appropriate to the location under evaluation. In addition, the effects of a proposed floodplain action on lives and property shall be evaluated. For an action proposed in a wetland, the effects on the survival, quality, and function of the wetland shall be evaluated.</p> <p>Alternatives. Consider alternatives to the proposed action that avoid adverse impacts and incompatible development in a wetland area, including alternate sites, alternate actions, and no action. DOE shall evaluate measures that mitigate the adverse effects of actions in a wetland, including but not limited to, minimum grading requirements, runoff controls, design and construction constraints, and protection of ecologically sensitive areas.</p> <p>If no practicable alternative to locating or conducting the action in the wetland is available, then before taking action design or modify the action in order to minimize potential harm to or within the wetland, consistent with the policies set forth in Executive Order 11990.</p>	<p>DOE actions that involve potential impacts to, or take place within wetlands—applicable</p>	<p>10 <i>CFR</i> 1022.3(a)(7) and (8)</p> <p>10 <i>CFR</i> 1022.3(b), (c), (d)</p> <p>10 <i>CFR</i> 1022.13(a)(1)</p> <p>10 <i>CFR</i> 1022.13(a)(2)</p> <p>10 <i>CFR</i> 1022.13(a)(3)</p> <p>10 <i>CFR</i> 1022.14(a)</p>

Table B.1. Location-specific applicable or relevant and appropriate requirements for selected alternative (cont.)

Location Resource	Requirements	Prerequisite	Citation
<p>Presence of jurisdictional wetlands as defined in 40 <i>CFR</i> 230.3, 33 <i>CFR</i> 328.3(a), and 33 <i>CFR</i> 328.4</p>	<p>No discharge of dredged or fill material into waters of the U.S., including jurisdictional wetlands, is permitted if there is a practical alternative that would have less adverse impact on the wetland or if it will cause or contribute significant degradation of waters of the U.S.</p> <p>Except as provided under CWA Sect. 404(b)(2), no discharge of dredged or fill material shall be permitted unless appropriate and practicable steps (in accordance with 40 <i>CFR</i> 230.70 <i>et seq</i>, <i>Actions to Minimize Adverse Effects</i>) have been taken, which will minimize potential adverse impacts of the discharge on the aquatic ecosystem.</p> <p>No discharge of dredged or fill material shall be permitted if it:</p> <p>Causes or contributes, after consideration of disposal site dilution and dispersion, to violations of any applicable State water quality standard;</p> <p>Violates any applicable toxic effluent standard or prohibition under Sect. 307 of the CWA:</p> <p>Jeopardizes the continued existence of species listed as endangered or threatened under the Endangered Species Act of 1973, as amended, or results in likelihood of the destruction or adverse modification of a habitat that is determined by the Secretary of Interior of Commerce, as appropriate, to be critical habitat under the Endangered Species Act of 1973, as amended. If an exemption has been granted by the Endangered Species Committee, the terms of such exemption shall apply in lieu of this subparagraph.</p> <p>Violates any requirement imposed by the Secretary of Commerce to protect any marine sanctuary designated under Title III of the Marine Protection, Research, and Sanctuaries Act of 1972.</p>	<p>Actions that involve discharge of dredged or fill material into waters of U.S., including jurisdictional wetlands—applicable</p>	<p>40 <i>CFR</i> 230.10(a), (b), (c) and (d) 40 <i>CFR</i> 230, Subpart H</p> <p>40 <i>CFR</i> 230.10(d)</p> <p>CWA Regulations – Sect. 404(b) Guidelines</p> <p>40 <i>CFR</i> 230.10(b)</p>
<p>Mitigation of impacts to state wetlands as defined under TDEC 0400-40-07-.03</p>	<p>If an activity in a wetland results in an appreciable permanent loss of resource values, mitigation must be provided that results in no overall net loss of resource values from existing conditions. To the extent practicable, any required mitigation shall be completed, excluding monitoring, prior to, or simultaneous with, any impacts. Acceptable mitigation mechanisms include any combination of in-lieu fee programs, mitigation banks, or other mechanisms that are reasonably assured to result in no overall net loss of resource values from existing conditions. Acceptable mitigation methods are prioritized in the following order: restoration, enhancement, preservation, creation, or any other measures that are reasonably assured to result in no net loss of resource values from existing conditions.</p> <p>Compensatory measures must be at a ratio of 2:1 for restoration, 4:1 for creation and enhancement, and 10:1 for preservation, or at a best professional judgment ratio agreed to by the state.</p>	<p>Activity that would cause loss of wetlands as defined in TDEC 0400-40-07-.03—applicable</p>	<p>TDEC 0400-40-07-.04(7)(a) TDEC 0400-40-07-.04(7)(c)</p>

Table B.1. Location-specific applicable or relevant and appropriate requirements for selected alternative (cont.)

Location Resource	Requirements	Prerequisite	Citation
Presence of wetlands	<p>Shall take action to minimize the destruction, loss, or degradation of wetlands and to preserve and enhance beneficial values of wetlands.</p> <p><i>NOTE:</i> Federal agencies required to comply with Executive Order 11990 requirements.</p> <p>Shall avoid undertaking construction located in wetlands unless: (1) there is no practicable alternative to such construction and (2) the proposed action includes all practicable measures to minimize harm to wetlands that may result from such use.</p>	Federal actions that involve potential impacts to, or take place within, wetlands - TBC	<p>Executive Order 11990</p> <p>Section 1.(a) <i>Protection of Wetlands</i></p> <p>Executive Order 11990, Section 2.(a) <i>Protection of Wetlands</i></p>
Presence of Wetlands (as defined in 44 <i>CFR</i> 9.4)	<p>The Agency shall minimize¹ the destruction, loss, or degradation of wetlands.</p> <p>The Agency shall preserve and enhance the natural and beneficial wetlands values.</p> <p>The Agency shall minimize:</p> <ul style="list-style-type: none"> • Potential adverse impact the action may have on wetland values. 	Federal actions affecting or affected by Wetlands as defined in 44 <i>CFR</i> 9.4 - relevant and appropriate	<p>44 <i>CFR</i> 9.11(b)(2) and (b)(4) <i>Mitigation</i></p> <p>44 <i>CFR</i> 9.11(c)(3) <i>Minimization provisions</i></p>
General Compensatory Mitigation for Wetlands	<p>Compensatory mitigation required to offset unavoidable impacts to waters of the United States authorized by DA permits.</p> <p>Compensatory mitigation requirements must be commensurate with the amount and type of impact that is associated with a particular DA permit.</p> <ul style="list-style-type: none"> • Amount of required compensatory mitigation must be, to the extent practicable, sufficient to replace lost aquatic resource functions. • Compensatory mitigation may be provided through mitigation banks or in-lieu fee programs. • Implementation of the compensatory mitigation project shall be, to the maximum extent practicable, in advance of or concurrent with the impact-causing activity. <p><i>NOTE:</i> Although permits are not required per CERCLA Section 121(e)(1), consultation with the USACE recommended to determine mitigation of any adverse impacts. Such mitigation would be performed as part of the remedial action.</p> <p>Compensatory mitigation may be performed using the methods of restoration, enhancement, establishment, and in certain circumstances preservation.</p> <p>Restoration should generally be the first option considered because the likelihood of success is greater and the impacts to potentially ecologically important uplands are reduced compared to establishment, and the potential gains in terms of aquatic resource functions are greater, compared to enhancement and preservation.</p>	<p>Alteration of wetlands requiring compensatory mitigation to replace lost aquatic resource functions – relevant and appropriate</p> <p>Alteration of wetlands requiring compensatory mitigation to replace lost aquatic resource functions – relevant and appropriate</p>	<p>40 <i>CFR</i> 230.93(a)(1) <i>General compensatory mitigation requirements</i></p> <p>40 <i>CFR</i> 230.93 (a)(2)</p>

¹ *Minimize* means to reduce to smallest amount or degree possible. 44 *CFR* 9.4, *Definitions*.

Table B.1. Location-specific applicable or relevant and appropriate requirements for selected alternative (cont.)

Location Resource	Requirements	Prerequisite	Citation
General Compensatory Mitigation for Wetlands (cont.)	<p>All compensatory mitigation projects must comply with the standards in this part (40 <i>CFR</i> Part 230), if they are to be used to provide compensatory mitigation for activities authorized by DA permits, regardless of whether they are sited on public or private lands and whether the sponsor is a governmental or private entity.</p> <p><i>NOTE:</i> Although permits are not required per CERCLA Section 121(e)(1), consultation with the USACE recommended to determine mitigation of any adverse impacts. Such mitigation would be performed as part of the remedial action.</p> <p>Required compensatory mitigation should be located within the same watershed as the impact site and should be located where it is most likely to successfully replace lost functions and services, taking into account such watershed scale features as aquatic habitat diversity, habitat connectivity, relationships to hydrologic sources (including the availability of water rights), trends in land use, ecological benefits, and compatibility with adjacent land uses.</p> <p>Project site must be ecologically suitable for providing the desired aquatic resource functions. In determining the ecological suitability of the compensatory mitigation project site, the district engineer project site, to the extent practicable, the factors in subsections (i) thru (vi).</p> <p>Applicants should propose compensation sites adjacent to existing aquatic resources or where aquatic resources previously existed.</p> <p>In general, in-kind mitigation is preferable to out-of-kind mitigation because it is most likely to compensate for the functions and services lost at the impact site.</p> <p>Except as provided in paragraph (e)(2) of this section, the required compensatory mitigation shall be of a similar type to the affected aquatic resource.</p> <p>The amount of required compensatory mitigation must be, to the extent practicable, sufficient to replace lost aquatic resource functions. Where appropriate functional or condition assessment methods or other suitable metrics are available, these methods should be used where practicable to determine how much compensatory mitigation is required. If a functional or condition assessment or other suitable metric is not used, a minimum one-to-one acreage or linear foot compensation ratio must be used.</p> <p>Implementation of the compensatory mitigation project shall be, to the maximum extent practicable, in advance of or concurrent with the activity causing the authorized impacts. The district engineer shall require, to the extent appropriate and practicable, additional compensatory mitigation to offset temporal losses of aquatic functions that will result from the permitted activity.</p>		<p>40 <i>CFR</i> 230.93 (a)(3)</p> <p>40 <i>CFR</i> 230.93 (b) <i>Type and location of mitigation</i></p> <p>40 <i>CFR</i> 230.93 (d)(1) and (3) <i>Site selection</i></p> <p>40 <i>CFR</i> 230.93 (e)(1) <i>Mitigation type</i></p> <p>40 <i>CFR</i> 230.93 (f)(1) <i>Amount of compensatory mitigation</i></p> <p>40 <i>CFR</i> 230.93 (m) <i>Timing</i></p>

Table B.1. Location-specific applicable or relevant and appropriate requirements for selected alternative (cont.)

Location Resource	Requirements	Prerequisite	Citation
Compensatory Mitigation Planning	<p>Prepare a mitigation plan addressing objectives, site selection, site protection, baseline information, determination of credits, mitigation work plan, maintenance plan, performance standards, monitoring requirements, long-term management, and adaptive management.</p> <p><i>NOTE:</i> Plan would be part of CERCLA document, such as a Remedial Action Work Plan. Plan to include items described in 40 <i>CFR</i> 230.94(c)(2) through (c)(14).²</p>	Alteration of wetlands requiring compensatory mitigation to replace lost aquatic resource functions – relevant and appropriate	40 <i>CFR</i> 230.94(c) <i>Mitigation Plan</i>
Compensatory Mitigation Performance Standards	<p>The approved mitigation plan must contain performance standards that will be used to assess whether the project is achieving its objectives. Performance standards should relate to the objectives of the compensatory mitigation project, so that the project can be objectively evaluated to determine if it is developing into the desired resource type, providing the expected functions, and attaining any other applicable metrics (e.g., acres).</p> <p>Performance standards must be based on attributes that are objective and verifiable. Ecological performance standards must be based on the best available science that can be measured or assessed in a practicable manner.</p> <p>Performance standards may be based on variables or measures of functional capacity described in functional assessment methodologies, measurements of hydrology or other aquatic resource characteristics, and/or comparisons to reference aquatic resources of similar type and landscape position. The use of reference aquatic resources to establish performance standards will help ensure that those performance standards are reasonably achievable, by reflecting the range of variability exhibited by the regional class of aquatic resources as a result of natural processes and anthropogenic disturbances. Performance standards based on measurements of hydrology should take into consideration the hydrologic variability exhibited by reference aquatic resources, especially wetlands.</p>	Alteration of wetlands requiring compensatory mitigation to replace lost aquatic resource functions – relevant and appropriate	40 <i>CFR</i> 230.95 (a) <i>Ecological Performance Standards</i> 40 <i>CFR</i> 230.95 (b) <i>Ecological Performance Standards</i>
Compensatory Mitigation Project Monitoring	<p>Monitoring the compensatory mitigation project site is necessary to determine if the project is meeting its performance standards, and to determine if measures are necessary to ensure that the compensatory mitigation project is accomplishing its objectives.</p> <p>Compensatory mitigation project monitoring period shall be sufficient to demonstrate that project has met performance standards, but not less than 5 years.</p>	Alteration of wetlands requiring compensatory mitigation to replace lost aquatic resource functions – relevant and appropriate	40 <i>CFR</i> 230.96 (a) and (b) <i>Monitoring</i>

² If mitigation obligations will be met by securing credits from approved mitigation banks or in-lieu fee programs, mitigation plan needs to include only items described in Sect. 230.94(c)(5) and (c)(6), and name of mitigation bank or in-lieu fee program. 40 *CFR* 230.94(c)(1).

Table B.1. Location-specific applicable or relevant and appropriate requirements for selected alternative (cont.)

Location Resource	Requirements	Prerequisite	Citation
<p>Compensatory Mitigation Project Management</p>	<p>The aquatic habitats, riparian areas, buffers, and uplands that comprise the overall compensatory mitigation project must be provided long-term protection through real estate instruments or other available mechanisms, as appropriate.</p> <p>For government property, long-term protection may be provided through federal facility management plans or integrated natural resources management plans.</p> <p><i>NOTE:</i> Plan would be part of CERCLA document, such as a Remedial Action Work Plan and/or Operations and Maintenance Plan.</p> <p>Projects shall be designed, to the maximum extent practicable, to be self-sustaining once performance standards have been achieved.</p> <p>This includes minimization of active engineering features (e.g., pumps) and appropriate siting to ensure that natural hydrology and landscape context will support long-term sustainability. Where active long-term management and maintenance are necessary to ensure long-term sustainability (e.g., prescribed burning, invasive species control, maintenance of water-control structures, easement enforcement), the responsible party must provide for such management and maintenance.</p>	<p>Alteration of wetlands on <i>government property</i> requiring compensatory mitigation to replace lost aquatic resource functions – relevant and appropriate</p>	<p>40 <i>CFR</i> 230.97 (a)(1) <i>Site Protection</i></p> <p>40 <i>CFR</i> 230.97 (b) <i>Sustainability</i></p>
<p>Minor alterations to wetlands</p>	<p>Minor alteration to wetlands must be conducted in accordance with the requirements of the ARAP Program (TDEC 0400-40-07). The substantive general permit requirements for minor alteration to wetlands include the following:</p> <ul style="list-style-type: none"> • Excavation and fill activities associated with wetland alteration shall be kept to a minimum • Wetlands outside of the impact areas shall be clearly marked with signs, high visibility fencing, or similar structures so that all the work performed by the contractor is solely within the permitted impact area. • Wetland alterations shall not cause measurable degradation to resource values and classified uses of hydraulically connected wetlands or other waters of the state, including disruption of sustaining surface or groundwater hydrology. • Temporary impacts to wetlands shall be mitigated by the removal and stockpiling of the first 12 in. of topsoil, prior to construction. Temporary wetland crossings or haul roads shall utilize timber matting. Gravel, riprap, or other rock is not approved for construction of temporary crossings or haul roads across wetlands. Upon completion of construction activities, all temporary wetland impact areas are to be restored to pre-construction contours, and the stockpiled topsoil spread to restore these areas to pre-construction elevation. Other side-cast material shall not be placed within the temporary impact locations. Permanent vegetative stabilization using native species of all disturbed areas in or near the wetland must be initiated within 14 days of project completion. Non-native, non-invasive annuals may be used as cover crops until native species can be established. 	<p>Minor alterations of up to 0.10 acre of moderate resource value wetlands or of up to 0.25 acre of degraded and of low resource value wetlands — applicable</p>	<p>TCA 69-3-108(1) TDEC 0400-40-07-.01 TDEC ARAP General Permit for Minor Alterations to Wetlands (effective April 7, 2020) (TBC)</p>

Table B.1. Location-specific applicable or relevant and appropriate requirements for selected alternative (cont.)

Location Resource	Requirements	Prerequisite	Citation
Minor alterations to wetlands (cont.)	<ul style="list-style-type: none"> • Erosion prevention and sediment-control measures such as fences shall be removed following completion of construction. • The amount of fill, stream channel and bank modifications, or other impacts associated with the activity shall be limited to the minimum necessary to accomplish the project purpose. Shall utilize the least impactful practicable method of construction. • Clearing, grubbing, or other disturbance to wetland vegetation shall be kept at the minimum. Unnecessary native vegetation removal, including tree removal, and soil disturbance is prohibited. Native wetland vegetation must be reestablished in all areas of disturbance outside of any permanent structure after work is completed. • Activity may not result in a disruption or barrier to the movement of fish or other aquatic life and wetland dependent species upon project completion. • Blasting within 50 ft of any jurisdictional stream or wetland is prohibited. • Where practicable, all activities shall be accomplished during drier times of the year or when recent conditions have been dry at the impact location. All surface water flowing towards or from the construction activity shall be diverted using cofferdams and/or berms constructed of sandbags, steel sheeting, or other non-erodible, non-toxic material. All such diversion materials shall be located outside the wetland and removed upon completion of the work. Activities may be conducted in the water if working in the dry will likely cause additional degradation. If work is conducted in the water, it must be of a short duration and with minimal impact. • All activities must be carried out in such a manner as will prevent violations of water quality criteria or impairment of the designated uses of the waters of the state • Erosion and sedimentation control shall be in place and functional before earthmoving operations begin and shall be designed according to the department’s Erosion and Sediment Control Handbook. Permanent vegetation stabilization using native species of all disturbed areas in or near the stream channel must be initiated within 14 days of the project completion. Non-native, non-invasive annuals may be used as cover crops until native species can be established. • The use of monofilament-type erosion-control netting or blanket is prohibited in the stream channel, stream banks, or any disturbed riparian areas within 30 ft of top of bank. 		

Table B.1. Location-specific applicable or relevant and appropriate requirements for selected alternative (cont.)

Location Resource	Requirements	Prerequisite	Citation
<i>Aquatic Resources</i>			
<p>Waters of the state as defined in TCA 69-3-103(45) – Bank stabilization</p>	<p>Bank-stabilization activities along state waters must be conducted in accordance with the requirements of the ARAP Program (TDEC 0400-40-07). The substantive general permit requirements for stream-bank stabilization include the following:</p> <ul style="list-style-type: none"> • Any spraying, mowing, or other disturbance of the stabilization treatment that interferes with its ability to naturalize is prohibited. • Work performed by vehicles and other related heavy equipment may not be staged within the stream channel. Work performed by hand and related hand-operated equipment is allowed within the stream channel. • Materials used for bank stabilization shall consist of rock, wood, or products made specifically for use in earthen slope stabilization. Other salvaged materials not found in the natural environment cannot be used for bank stabilization. • The amount of fill, stream channel and bank modifications, or other impacts associated with the activity shall be limited to the minimum necessary to accomplish the project purpose. Shall utilize the least impactful practicable method of construction. • Clearing, grubbing, or other disturbance to riparian vegetation shall be kept at the minimum necessary for slope construction and equipment operation. Unnecessary native riparian vegetation removal, including tree removal, is prohibited. Native riparian vegetation must be reestablished in all areas of disturbance outside of any permanent structure after work is completed. • Activity may not result in the permanent disruption to the movement of fish or other aquatic life upon project completion. • Blasting within 50 ft of any jurisdictional stream or wetland is prohibited. • Backfill activities must be accomplished in the least impactful manner possible that stabilizes the streambed and banks to prevent erosion. The completed activities may not disrupt or impound stream flow. • The use of monofilament-type erosion-control netting or blanket is prohibited in the stream channel, stream banks, or any disturbed riparian areas within 30 ft of top of bank. 	<p>Bank-stabilization activities affecting waters of the state—applicable</p>	<p>TCA 69-3-108(1) TDEC 0400-40-07-.01 TDEC ARAP General Permit for Bank Armoring and Vegetative Stabilization Activities (effective January 6, 2021) (TBC)</p>

Table B.1. Location-specific applicable or relevant and appropriate requirements for selected alternative (cont.)

Location Resource	Requirements	Prerequisite	Citation
Waters of the state as defined in TCA 69-3-103(45) – Bank stabilization (cont.)	<ul style="list-style-type: none"> • Where practicable, all activities shall be accomplished in the dry. All surface water flowing towards the work shall be diverted using cofferdams and/or berms constructed of sandbags, clean rock (no fines or soils), steel sheeting, or other non-erodible, non-toxic material. All such diversion materials shall be removed upon completion of the work. Any disturbance to the stream bed or banks must be restored to its original condition. Activities may be conducted in the water if working in the dry will likely cause additional degradation. If work is conducted in the water it must be of a short duration and with minimal impact and conform to the Division-approved methodology. • All activities must be carried out in such a manner as to prevent violations of water quality criteria or impairment of the designated uses of the waters of the state • Erosion and sedimentation control shall be in place and functional before earthmoving operations begin and shall be designed according to the department’s Erosion and Sediment Control Handbook. Permanent vegetation stabilization using native species of all disturbed areas in or near the stream channel must be initiated within 14 days of the project completion. Non-native, non-invasive annuals may be used as cover crops until native species can be established. • Temporary stream crossings shall be limited to one point in the construction area and erosion-control measures shall be utilized where stream bank vegetation is disturbed. Stream beds shall not be used as linear transportation routes for mechanized equipment, rather, the stream channel may be crossed perpendicularly with equipment provided no additional fill or excavation is necessary. • Hard armoring bank stabilization treatment shall not exceed 300 linear ft for the treatment of one bank, or 200 linear ft per bank if the treatment includes both banks. 		
Waters of the state as defined in TCA 69-3-103(45) – Culvert maintenance activities	<p>The maintenance of existing serviceable structures or fills along waters of the state must be conducted in accordance with the requirements of the ARAP Program (TDEC 0400-40-07). The substantive general permit requirements for maintenance activities include the following:</p> <ul style="list-style-type: none"> • The length of the pipe or culvert structure may not be increased in a manner that encapsulates any additional length of open stream or wetland. • The capacity or diameter of the culvert may be increased during replacement, providing it does not result in channel widening or other channel destabilization. • Dewatering of impoundments to conduct dam maintenance must be performed in a controlled manner designed to prevent the release of accumulated sediments into downstream waters. 	Maintenance activities affecting waters of the state— applicable	TCA 69-3-108(1) TDEC 0400-40-07-.01 TDEC ARAP General Permit for Maintenance Activities (effective April 7, 2020) (TBC)

Table B.1. Location-specific applicable or relevant and appropriate requirements for selected alternative (cont.)

Location Resource	Requirements	Prerequisite	Citation
<p>Waters of the state as defined in TCA 69-3-103(45) – Culvert maintenance activities (cont.)</p>	<ul style="list-style-type: none"> • All riprap associated with maintenance activities shall be placed to mimic the existing contours of the stream channel. Riprap shall be countersunk and placed at grade with the existing stream substrate. Voids in the riprap shall be filled with suitable bedload substrate to prevent stream flow loss within riprap areas. Suitable substrate does not include soil. • Work performed by vehicles and other heavy equipment may not be staged within the stream channel. Work performed by hand and related hand-operated equipment is allowed within the stream channel. • The amount of fill, stream channel and bank modifications, or other impacts associated with the activity shall be limited to the minimum necessary to accomplish the project purpose. Shall utilize the least impactful practicable method of construction. • Clearing, grubbing, or other disturbance to riparian vegetation shall be kept at the minimum necessary for slope construction and equipment operations. Unnecessary native riparian vegetation removal, including tree removal is prohibited. Native riparian vegetation must be reestablished in all areas of disturbance outside of any permanent structure after work is completed. • Widening of the stream channel is prohibited. • Activity may not result in a permanent disruption to the movement of fish or other aquatic life upon project completion. • Blasting within 50 ft of any jurisdictional stream or wetland is prohibited. • Backfill activities must be accomplished in the least impactful manner possible that stabilizes the streambed and banks to prevent erosion. The completed activities may not disrupt or impound stream flow. • The use of monofilament-type erosion-control netting or blanket is prohibited in the stream channel, stream banks, or any disturbed riparian areas within 30 ft of top of bank. • Where practicable, all activities shall be accomplished in the dry. All surface water flowing towards the work shall be diverted using cofferdams and/or berms constructed of sandbags, clean rock (no fines or soils), steel sheeting, or other non-erodible, non-toxic material. All such diversion materials shall be removed upon completion of the work. Any disturbance to the stream bed or banks must be restored to its original condition. Activities may be conducted in the flowing water if working in the dry will likely cause additional degradation. If work is conducted in the flowing water it must be of a short duration and with minimal impact and conform to the Division-approved methodology. • All activities must be carried out in such a manner as to prevent violations of water quality criteria or impairment of the designated uses of the waters of the state 		

Table B.1. Location-specific applicable or relevant and appropriate requirements for selected alternative (cont.)

Location Resource	Requirements	Prerequisite	Citation
Waters of the state as defined in TCA 69-3-103(45) – Culvert maintenance activities (cont.)	<ul style="list-style-type: none"> • Erosion and sedimentation control shall be in place and functional before earthmoving operations begin and shall be designed according to the department’s Erosion and Sediment Control Handbook. Permanent vegetation stabilization using native species of all disturbed areas in or near the stream channel must be initiated within 14 days of the project completion. Non-native, non-invasive annuals may be used as cover crops until native species can be established. • Temporary stream crossings shall be limited to one point in the construction area and erosion-control measures shall be utilized where stream bank vegetation is disturbed. Stream beds shall not be used as linear transportation routes for mechanized equipment, rather, the stream channel may be crossed perpendicularly with equipment provided no additional fill or excavation is necessary. 		
Alteration of a Wet Weather Conveyance	<p>Wet-weather conveyances may be altered provided the following conditions are met:</p> <ul style="list-style-type: none"> • The activity must not result in the discharge of waste or other substances that may be harmful to humans or wildlife. • Material must not be placed in a location or manner so as to impair surface water flow into or out of any wetland area. • Sediment shall be prevented from entering other waters of the state. • Erosion/sediment controls shall be designed according to size and slope of disturbed or drainage areas to detain runoff and trap sediment and shall be properly selected, installed, and maintained in accordance with manufacturer’s specifications and good engineering practices. • Erosion/sediment-control measures must be in place and functional before earthmoving operations begin, and must be constructed and maintained throughout the construction period. Temporary measures may be removed at the beginning of the work day, but shall be replaced at end of the work day. • Checkdams must be utilized where runoff is concentrated. Clean rock, log, sandbag, or straw bale checkdams shall be properly constructed to detain runoff and trap sediment. Checkdams or other erosion-control devices are not to be constructed in stream. Clean rock can be of various type and size depending on the application and must not contain fines, soils, or other wastes or contaminants. • Appropriate steps must be taken to ensure that petroleum products or other chemical pollutants are prevented from entering waters of the state. All spills shall be reported to the appropriate emergency management agency and TDEC. In event of a spill, measures shall be taken immediately to prevent pollution of waters of the state, including groundwater. 	Activities that alter wet-weather conveyances— applicable	TCA 69-3-108(q)

Table B.1. Location-specific applicable or relevant and appropriate requirements for selected alternative (cont.)

Location Resource	Requirements	Prerequisite	Citation
<p>Location encompassing aquatic ecosystem as defined as 40 <i>CFR</i> 230.3(c)</p>	<p>No discharge of dredged or fill material into an aquatic ecosystem is permitted if there is a practical alternative that would have less adverse impact on the aquatic ecosystem or if it will cause or contribute significant degradation of waters of the U.S.</p> <p>Except as provided under CWA Sect. 404(b)(2), no discharge of dredged or fill material shall be permitted unless appropriate and practicable steps (in accordance with 40 <i>CFR</i> 230.70 <i>et seq.</i>, <i>Actions to Minimize Adverse Effects</i>) have been taken that will minimize potential adverse impacts of the discharge on the aquatic ecosystem.</p> <p>No discharge of dredged or fill material shall be permitted if it:</p> <p>Causes or contributes, after consideration of disposal site dilution and dispersion, to violations of any applicable State water quality standard.</p> <p>Violates any applicable toxic effluent standard or prohibition under Sect. 307 of the CWA:</p> <ul style="list-style-type: none"> • Jeopardizes the continued existence of species listed as endangered or threatened under the Endangered Species Act of 1973, as amended, or results in likelihood of the destruction or adverse modification of a habitat that is determined by the Secretary of Interior of Commerce, as appropriate, to be critical habitat under the Endangered Species Act of 1973, as amended. If an exemption has been granted by the Endangered Species Committee, the terms of such exemption shall apply in lieu of this subparagraph. • Violates any requirement imposed by the Secretary of Commerce to protect any marine sanctuary designated under Title III of the Marine Protection, Research, and Sanctuaries Act of 1972. 	<p>Action that involves the discharge of dredged or fill material into “waters of the U.S.,” including jurisdictional wetlands—applicable</p>	<p>40 <i>CFR</i> 230.10(a), and (c) CWA Regulations – Sect. 404(b) Guidelines</p> <p>40 <i>CFR</i> 230.10(d)</p> <p>CWA Regulations – Sect. 404(b) Guidelines</p> <p>40 <i>CFR</i> 230.10(b)</p>
<p>Mitigation of impacts to a stream as defined in TDEC 0400-40-07-.03, which includes all surface water except wetlands and wet weather conveyances</p>	<p>If an activity in a stream results in an appreciable permanent loss of resource values, the applicant must provide mitigation that results in no overall net loss of resource values from existing conditions. To the extent practicable, any required mitigation shall be completed, excluding monitoring, prior to, or simultaneous with, any impacts. Acceptable mitigation mechanisms include any combination of in-lieu fee programs, mitigation banks, or other mechanisms that are reasonably assured to result in no overall net loss of resource values from existing conditions. Acceptable mitigation methods are prioritized in the following order: restoration, enhancement, preservation, creation, or any other measures that are reasonably assured to result in no net loss of resource values from existing conditions.</p> <p>Mitigation for impacts to streams must be developed in a scientifically defensible manner that demonstrates a sufficient increase in resource values to compensate for impacts. At a minimum, all new or relocated streams must include a vegetated riparian zone, demonstrate lateral and vertical channel stability, and have a natural channel bottom. All mitigation watercourses must maintain or improve flow and classified uses after mitigation is complete.</p>	<p>Activity that would result in an appreciable permanent loss of resource value of a stream as defined in TDEC 0400-40-07-.03 —applicable</p>	<p>TDEC 0400-40-07-.04(7)(a) TDEC 0400-40-07-.04(7)(b) 2019 Tennessee Stream Mitigation Guidelines (TBC) TDEC Stream Quantitative Tool Workbook (TBC)</p>

Table B.1. Location-specific applicable or relevant and appropriate requirements for selected alternative (cont.)

Location Resource	Requirements	Prerequisite	Citation
Within area impacting stream or any other body of water <i>-and-</i> presence of wildlife resources (e.g., fish)	The effects of water-related projects on fish and wildlife resources and their habitat should be considered with a view to the conservation of fish and wildlife resources by preventing loss of and damage to such resources.	Action that impounds, modifies, diverts, or controls waters, including navigation and drainage activities— relevant and appropriate	Fish and Wildlife Coordination Act [16 <i>USC</i> 662(a)]
<i>Cultural Resources</i>			
Presence of historical resources on public land	<p>Federal agencies must take into account the effects of their undertakings on historic properties.</p> <p>Determine whether the proposed federal action is an undertaking as defined in §800.16(y) and, if so, whether it is a type of activity that has the potential to cause effects on historic properties.</p> <p>Determine and document the area of potential effects, as defined in §800.16(d).</p> <p>Review existing information on historic properties within the area of potential effects, including any data concerning possible historic properties not yet identified.</p> <p>Take the steps necessary to identify historic properties within the area of potential effects.</p> <p>Apply the National Register criteria (36 <i>CFR</i> 63) to properties identified within the area of potential effects that have not been previously evaluated for National Register eligibility. If the agency official determines any of the National Register criteria are met and the SHPO/THPO agrees, the property shall be considered eligible for the National Register for Sect. 106 purposes.</p> <p>Shall apply the criteria of adverse effect to historic properties within the area of potential effects.</p> <p>Shall ensure that a determination, finding, or agreement under the procedures in this subpart is supported by sufficient documentation to enable any reviewing parties to understand its basis.</p>	Federal agency undertaking that may impact historical properties listed or eligible for inclusion on the National Register of Historic Places— applicable	<p>36 <i>CFR</i> 800.1(a)</p> <p>36 <i>CFR</i> 800.3(a)</p> <p>36 <i>CFR</i> 800.4(a)(1)–(2)</p> <p>36 <i>CFR</i> 800.4(b)</p> <p>36 <i>CFR</i> 800.4(c)(1)–(2)</p> <p>36 <i>CFR</i> 800.5(a)</p> <p>36 <i>CFR</i> 800.11(a)</p>
Presence of archaeological resources on public land	No person may excavate, remove, damage, or otherwise alter or deface, or attempt to excavate, remove, damage, or otherwise alter or deface any archaeological resource located on public lands or Indian lands unless such activity is pursuant to a permit issued under §7.8 or exempted by §7.5(b) of this part.	Action that would cause the irreparable loss or destruction of significant historic or archaeological resources or data on public land— applicable	43 <i>CFR</i> 7.4(a)

Table B.1. Location-specific applicable or relevant and appropriate requirements for selected alternative (cont.)

Location Resource	Requirements	Prerequisite	Citation
<p>Presence of human remains, funerary objects, sacred objects, or objects of cultural patrimony</p>	<p>Intentional excavation of human remains, funerary objects, sacred objects, or objects of cultural patrimony from federal or tribal lands may be conducted only if:</p> <ul style="list-style-type: none"> • The objects are excavated or removed following the requirements of the ARPA (16 USC 470aa et seq.) and its implementing regulations, and • The disposition of the objects is consistent with their custody as described in §10.6. <p>Must take reasonable steps to determine whether a planned activity may result in the excavation of human remains, funerary objects, sacred objects, or objects of cultural patrimony from federal lands.</p> <p>If inadvertent discovery occurred in connection with an on-going activity on federal or tribal lands, in addition to providing the notice described above, must stop activities in the area of the inadvertent discovery and make a reasonable effort to protect the human remains, funerary objects, sacred objects, or objects of cultural patrimony discovered inadvertently.</p> <p>Must take immediate steps, if necessary, to further secure and protect inadvertently discovered human remains, funerary objects, sacred objects, or objects of cultural patrimony, including, as appropriate, stabilization or covering.</p>	<p>Action involving alteration of terrain that might cause irreparable loss or destruction of any discovered significant scientific, prehistoric, historic, or archaeological resources—applicable</p> <p>Excavation activities that inadvertently discover such resources on federal lands or under federal control—applicable</p>	<p>43 CFR 10.3(b)(1) and (3)</p> <p>43 CFR 10.3(c)</p> <p>43 CFR 10.4(c)</p> <p>43 CFR 10.4(d)(ii)</p>
<p>Presence of a cemetery</p>	<p>Intentional desecration of a place of burial without legal privilege or authority to do so is prohibited.</p> <p>Disinterment of a corpse that has been buried or otherwise interred, without legal privilege or authority to do so, is prohibited.</p>	<p>Action that would alter or destroy property in a cemetery—applicable</p>	<p>TCA 39-17-311(a)(1)</p> <p>TCA 39-17-312(a)(2)</p>
<i>Endangered, Threatened, or Rare Species</i>			
<p>Presence of federally endangered or threatened species, as designated in 50 CFR 17.11 and 17.12 or critical habitat of such species</p>	<p>Actions that jeopardize the existence of a listed species or results in the destruction or adverse modification of critical habitat must be avoided or reasonable and prudent mitigation measures taken.</p>	<p>Action that is likely to jeopardize fish, wildlife, or plant species or destroy or adversely modify critical habitat—applicable</p>	<p>16 USC 1531 et seq., Endangered Species Act Sect. 7(a)(2)</p>
<p>Presence of Tennessee-listed endangered or rare plant species as listed in TDEC 0400-06-02-.04</p>	<p>May not knowingly uproot, dig, take, remove, damage, destroy, possess, or otherwise disturb for any purposes any endangered species.</p>	<p>Action impacting rare plant species, including, but not limited to federally listed endangered species—applicable</p>	<p>16 USC 1531 et seq. TCA 70-8-309(a) TDEC 0400-06-02-.04 Tennessee Natural Heritage Program Rare Plant List (2016) (TBC)</p>

Table B.1. Location-specific applicable or relevant and appropriate requirements for selected alternative (cont.)

Location Resource	Requirements	Prerequisite	Citation
Presence of Tennessee non-game species as defined in <i>TCA</i> 70-8-103 and listed in TWRA Proclamations 00-14 and 00-15	<p>May not take (i.e., harass, hunt, capture, kill or attempt to kill), possess, transport, export, or process wildlife species.</p> <p>May not knowingly destroy the habitat of such species. Certain exceptions may be allowed for reasons such as education, science, etc., or where necessary to alleviate property damage or protect human health or safety.</p> <p>Upon good cause shown and where necessary to protect human health or safety, endangered or threatened species or “in need of management” species may be removed, captured, or destroyed.</p>	Action impacting Tennessee non-game species, including wildlife species which are "in need of management" (as listed in TWRA Proclamations 00-14 and 00-15 as amended by 00-21)— applicable	<i>TCA</i> 70-8-104(b) and (c) <i>TCA</i> 70-8-106(e) TWRA Proclamations 00-14, Sect. II and 00-15, Sect. II, as amended by Proclamation 00-21 (TBC)
Presence of migratory birds as defined in 50 <i>CFR</i> 10.13, and their habitats	<p>Unlawful killing, possession, and sale of migratory bird species, as defined in 50 <i>CFR</i> 10.13, native to the U.S. or its territories is prohibited.</p> <p>Requirements are as follows:</p> <ul style="list-style-type: none"> • Avoid or minimize, to the extent practicable, adverse impacts on migratory bird resources when conducting agency action • Restore and enhance the habitats of migratory birds, as practicable • Prevent or abate the pollution or detrimental alteration of the environment for the benefit of migratory birds, as practicable. 	<p>Action that is likely to impact migratory birds—applicable</p> <p>Federal agency action that is likely to impact migratory birds—TBC</p>	<p>16 <i>USC</i> 703-704</p> <p>Executive Order 13186</p>

ARAP = aquatic resource alteration permit
 ARPA = Archaeological Resources Protection Act
 CERCLA = Comprehensive Environmental Response, Compensation, and Liability Act of 1980
CFR = Code of Federal Regulations
 CWA = Clean Water Act of 1972
 DA = Department of the Army
 DOE = U.S. Department of Energy
 SHPO = State Historic Preservation Officer

TBC = to-be-considered (guidance)
TCA = Tennessee Code Annotated
 TDEC = Tennessee Department of Environment and Conservation
 THPO = Tennessee Historic Preservation Officer
 TWRA = Tennessee Wildlife Resources Agency
 U.S. = United States
 USACE = U.S. Army Corps of Engineers
USC = United States Code

Table B.2. Action-specific applicable or relevant and appropriate requirements for selected alternative

Action	Requirements	Prerequisite	Citation
<i>General Landfill Design</i>			
Site design for a LLW disposal facility	Surface features must direct surface water drainage away from disposal units at velocities and gradients that will not result in erosion that will require ongoing active maintenance in the future.	Design of a LLW disposal facility— relevant and appropriate	TDEC 0400-20-11-.17(2)(e)
<i>Construction Requirements</i>			
Activities causing fugitive dust emissions	<p>Shall take reasonable precautions to prevent particulate matter from becoming airborne. Reasonable precautions shall include, but are not limited to, the following:</p> <ul style="list-style-type: none"> • Use, where possible, of water or chemicals for control of dust in demolition of existing buildings or structures, construction operations, grading of roads, or the clearing of land. • Application of asphalt, water, or suitable chemicals on dirt roads, materials stockpiles, and other surfaces that can create airborne dusts. • Shall not cause or allow fugitive dust to be emitted in such a manner to exceed 5 minute/hour or 20 minute/day beyond property boundary lines on which emission originates. 	Use, construction, alteration, repair, or demolition of a building, or appurtenances or a road or the handling, transport, or storage of material— applicable	<p>TDEC 1200-3-8-.01(1)</p> <p>TDEC 1200-3-8-.01(1)(a)</p> <p>TDEC 1200-3-8-.01(1)(b)</p> <p>TDEC 1200-3-8-.01(2)</p>
Activities causing stormwater runoff	<p>Shall develop and implement stormwater-management controls to ensure compliance with the terms and conditions of <i>General Permit No. TNR050000</i> (“Stormwater Multi-Sector General Permit for Industrial Activities”) or any applicable site-specific permit.</p> <p>Shall develop and maintain a stormwater pollution prevention/control plan prepared in accordance with good engineering practices and with the factors outlined in 40 <i>CFR</i> 125.3(d)(2) or (3), as appropriate, and any additional requirements listed in Part 11 for the particular sector of industrial activity. The plan shall identify potential sources of pollution that may reasonably be expected to affect the quality of stormwater discharges associated with industrial activity.</p> <p>Stormwater pollution prevention plans shall include, at a minimum, the items identified in <i>General Permit No. TNR050000 Sector K.3</i>, including a description of potential pollution sources, stormwater-management measures and controls, preventive maintenance, spill prevention and response procedures, and sediment and erosion controls.</p>	<p>Existing and new stormwater discharges associated with industrial activity—applicable</p> <p>Stormwater discharges associated with industrial activity at hazardous waste treatment, storage or disposal facilities—TBC</p>	<p><i>TCA</i> 69-3-108(e) through (j)</p> <p><i>TCA</i> 69-3-108(l)</p> <p>TDEC 0400-40-10-.03(2)(a)</p> <p><i>General Permit No. TNR05-0000</i>, Sector K (effective July 20, 2020) (TBC)</p> <p><i>General Permit No. TNR050000</i>, Sect. 4 (TBC)</p> <p><i>General Permit No. TNR050000 Sector K.3</i> (TBC)</p>

Table B.2. Action-specific applicable or relevant and appropriate requirements for selected alternative (cont.)

Action	Requirements	Prerequisite	Citation
<p>Activities causing stormwater runoff (e.g., clearing, grading, excavation)</p>	<p>Implement good construction management techniques (including sediment and erosion, vegetative controls, and structural controls) in accordance with the substantive requirements of <i>General Permit No. TNR10-0000</i> and <i>TNR05-0000</i>, to ensure stormwater discharge is properly managed and:</p> <ul style="list-style-type: none"> • Does not violate water quality criteria as stated in TDEC 0400-40-03-.03, including, but not limited to, prevention of discharge that cause a condition in which visible solids, bottom deposits, or turbidity impairs the usefulness of waters of the state for any designated uses for that water body by TDEC 0400-40-04. • Does not contain distinctly visible floating scum, oil, or other matter. • Does not cause an objectionable color contrast in the receiving stream. • Results in no materials in concentrations sufficient to be hazardous or otherwise detrimental to humans, livestock, wildlife, plant life, or fish and aquatic life in the receiving stream. • Discharges that would cause measurable degradation of waters with unavailable parameters are not authorized. To be eligible to obtain and maintain coverage, must satisfy, at a minimum, the following additional requirements for discharges into waters with unavailable parameters for siltation and habitat alterations due to in-channel erosion: <ul style="list-style-type: none"> ○ Measures used at the site must be designed to control stormwater runoff generated by a 5-year, 24-hour storm event at a minimum. <p>Additional physical or chemical treatment of stormwater runoff, such as use of treatment chemicals, may be necessary to minimize the amount of sediment being discharged when clay and other fine particle soils are found on sites.</p>	<p>Stormwater discharges associated with construction activities that disturb ≥ 1 acre total—relevant and appropriate</p>	<p><i>TCA 69-3-108(1)</i> Tennessee General Permit No. TNR10-0000, Sects. 5.3.2 and 5.4.1 (effective October 1, 2016) (TBC)</p>
<i>Emissions and Effluents</i>			
<p>Activities causing stormwater runoff (e.g., during operations)</p>	<p>Shall develop and implement stormwater management controls to insure [sic] compliance with the terms and conditions of <i>General Permit No. TNR050000</i> (“Stormwater Multi-Sector General Permit for Industrial Activities”) or any applicable site-specific permit and with TDEC 0400-40-10-.03(2)(c).</p> <p>Shall develop and maintain a stormwater pollution prevention/control plan prepared in accordance with good engineering practices and with the factors outlined in 40 <i>CFR</i> 125.3(d)(2) or (3), as appropriate, and any additional requirements listed in Part 11 for the particular sector of industrial activity. The plan shall identify potential sources of pollution that may reasonably be expected to affect the quality of stormwater discharges associated with industrial activity.</p>	<p>Stormwater discharges associated with industrial activity—applicable</p>	<p><i>TCA 69-3-108(e)</i> through (j) <i>TCA 69-3-108(1)</i> TDEC 0400-40-10-.03(2)(a) TDEC 0400-40-10-.03(2)(c)</p> <p><i>General Permit No. TNR050000</i>, Sector K (effective July 20, 2020) (TBC guidance)</p> <p><i>General Permit No. TNR050000</i>, Sect. 4</p>

Table B.2. Action-specific applicable or relevant and appropriate requirements for selected alternative (cont.)

Action	Requirements	Prerequisite	Citation
	Stormwater pollution prevention plans shall include, at a minimum, the items identified in <i>General Permit No. TNR050000 Sector K.3</i> , including a description of potential pollution sources, stormwater management measures and controls, preventive maintenance, spill prevention and response procedures, and sediment and erosion controls.	Stormwater discharges associated with industrial activity at hazardous waste treatment, storage, or disposal facilities— TBC	<i>General Permit No. TNR050000 Sector K.3</i>
<i>Secondary Waste and Waste Acceptance Criteria Attainment</i>			
Management and storage of used oil	<p>Used oil generators shall not store used oil in units other than tanks, containers, or units subject to regulation under TDEC 0400-12-01-.05 or -.06.</p> <p>Containers and aboveground tanks used to store used oil at generator facilities must be in good condition (no severe rusting, apparent structural defects, or deterioration) and not leaking (no visible leaks).</p> <p>Containers and aboveground tanks used to store used oil at generator facilities must be labeled or marked clearly with the words “Used Oil.”</p> <p>Upon detection of a release of used oil to the environment, a generator must stop the release; contain, clean up, and properly manage the released used oil; and, if necessary, repair or replace any leaking used oil storage containers or tanks prior to returning them to service.</p>	Generation and storage of used oil [as defined in TDEC 0400-12-01-.11(1)(a)] and possible release— applicable	<p>40 <i>CFR</i> 279.22(a) TDEC 0400-12-01-.11(3)(c)(1)</p> <p>40 <i>CFR</i> 279.22(b)(1) and (2) TDEC 0400-12-01-.11(3)(c)(2)(i) and (ii)</p> <p>40 <i>CFR</i> 279.22(c)(1) and (2) TDEC 0400-12-01-.11(3)(c)(3)(i) and (ii)</p> <p>40 <i>CFR</i> 279.22(d) TDEC 0400-12-01-.11(3)(c)(4)</p>
Pre-construction activities	Prior to excavation, all bore holes drilled or dug during subsurface investigation of the site, piezometers, and abandoned wells that are either in or within 100 ft of the areas to be filled must be backfilled with a bentonite slurry or other sealant approved by the Commissioner to an elevation at least 10 ft greater than the elevation of the lowest point of the landfill base (including any liner), or to the ground surface if the site will be excavated less than 10 ft below grade.	Construction of a solid waste disposal facility— relevant and appropriate	TDEC 0400-11-01-.04(2)(l)

CFR = Code of Federal Regulations

LLW = low level (radioactive) waste

TBC = to-be-considered (guidance)

TCA = Tennessee Code Annotated

TDEC = Tennessee Department of Environment and Conservation

APPENDIX C.
KEY GWFD DESIGN DRAWINGS AND SPECIFICATIONS

This page intentionally left blank.

KEY DESIGN DRAWINGS

This page intentionally left blank.

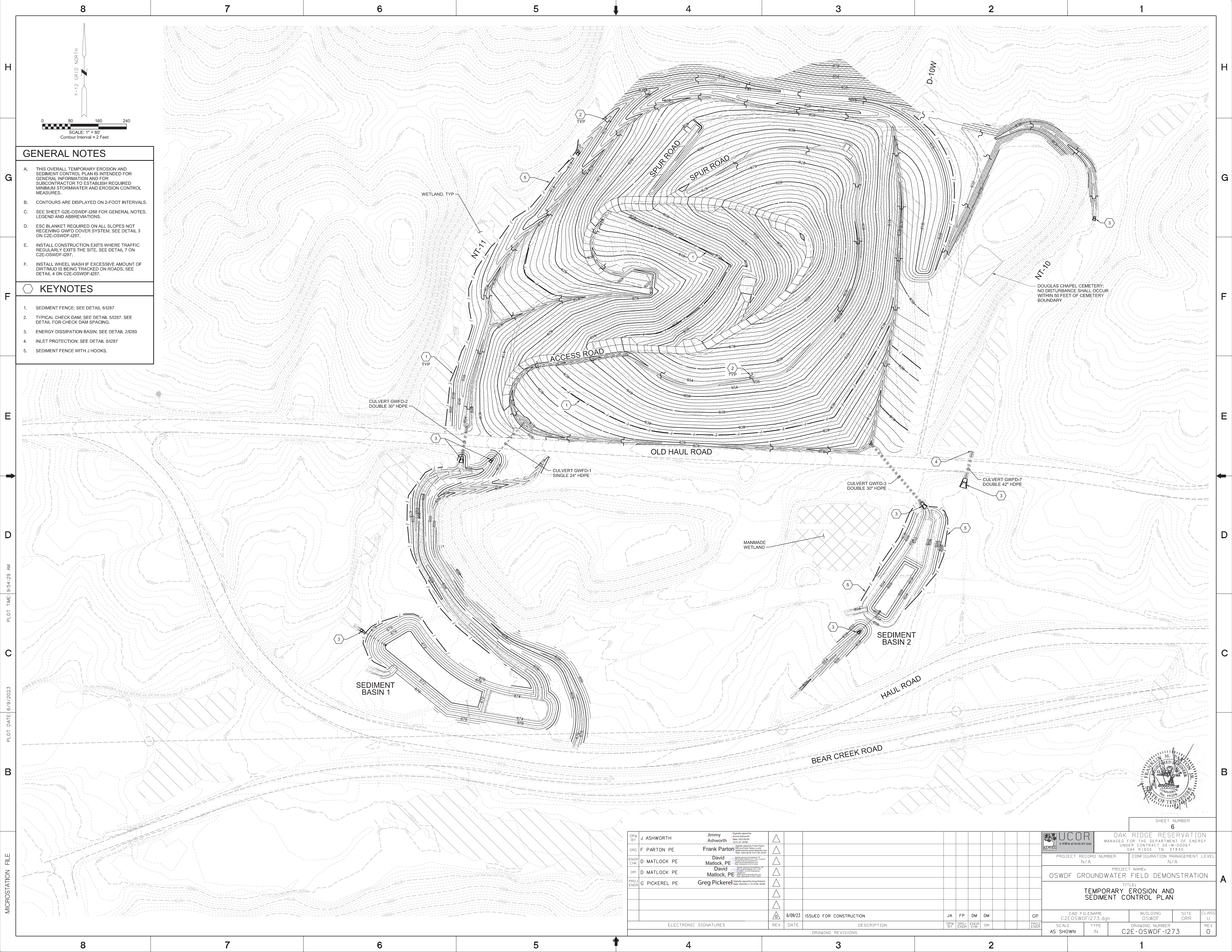

GENERAL NOTES

- A. THIS OVERALL TEMPORARY EROSION AND SEDIMENT CONTROL PLAN IS INTENDED FOR GENERAL INFORMATION AND FOR SUBCONTRACTOR TO ESTABLISH REQUIRED MINIMUM STORMWATER AND EROSION CONTROL MEASURES.
- B. CONTOURS ARE DISPLAYED ON 2-FOOT INTERVALS.
- C. SEE SHEET G2E-OSWDF-I268 FOR GENERAL NOTES, LEGEND AND ABBREVIATIONS.
- D. ESC BLANKET REQUIRED ON ALL SLOPES NOT RECEIVING GWFD COVER SYSTEM, SEE DETAIL 3 ON C2E-OSWDF-I287.
- E. INSTALL CONSTRUCTION EXITS WHERE TRAFFIC REGULARLY EXITS THE SITE, SEE DETAIL 7 ON C2E-OSWDF-I287.
- F. INSTALL WHEEL WASH IF EXCESSIVE AMOUNT OF DIRT/MUD IS BEING TRACKED ON ROADS, SEE DETAIL 4 ON C2E-OSWDF-I287.

KEYNOTES

- 1. SEDIMENT FENCE; SEE DETAIL 6I287
- 2. TYPICAL CHECK DAM; SEE DETAIL 5I287. SEE DETAIL FOR CHECK DAM SPACING.
- 3. ENERGY DISSIPATION BASIN; SEE DETAIL 2I289
- 4. INLET PROTECTION; SEE DETAIL 8I287
- 5. SEDIMENT FENCE WITH J HOOKS.

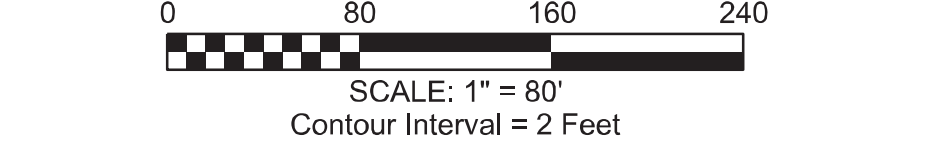

DRW BY: J ASHWORTH		Checked/Approved by: Jimmy Ashworth		DATE: 6/09/23		REV: 1		DATE: 6/09/23		DESCRIPTION: ISSUED FOR CONSTRUCTION		JA		FP		DM		DM		GP	
DRG: F PARTON PE		Frank Parton		Checked/Approved by: Frank Parton		DATE: 03/21/23		REV: 1		DESCRIPTION: ISSUED FOR CONSTRUCTION		JA		FP		DM		DM		GP	
ENGR CHK: D MATLOCK PE		David Matlock, PE		Checked/Approved by: David Matlock		DATE: 03/21/23		REV: 1		DESCRIPTION: ISSUED FOR CONSTRUCTION		JA		FP		DM		DM		GP	
DM: D MATLOCK PE		David Matlock, PE		Checked/Approved by: David Matlock		DATE: 03/21/23		REV: 1		DESCRIPTION: ISSUED FOR CONSTRUCTION		JA		FP		DM		DM		GP	
PRJ ENGR: G PICKEREL PE		Greg Pickerel		Checked/Approved by: Greg Pickerel		DATE: 03/21/23		REV: 1		DESCRIPTION: ISSUED FOR CONSTRUCTION		JA		FP		DM		DM		GP	
ELECTRONIC SIGNATURES		REV		DATE		DESCRIPTION		DRAWN BY		ENGR		ENGR		CHK		DM		PROJ ENGR		SCALE	
								AS SHOWN		TYPE		IN		DRAWING NUMBER		C2E-OSWDF-I273		REV		0	

UCOR OAK RIDGE RESERVATION
 MANAGED FOR THE DEPARTMENT OF ENERGY
 UNDER CONTRACT DE-AC05-04OR21400
 OAK RIDGE, TN 37830

PROJECT RECORD NUMBER: N/A
 CONFIGURATION MANAGEMENT LEVEL: N/A

PROJECT NAME: OSWDF GROUNDWATER FIELD DEMONSTRATION

TITLE: TEMPORARY EROSION AND SEDIMENT CONTROL PLAN

CAD FILENAME: C2E-OSWDF-I273.dgn
 BUILDING: OSWDF
 SITE: ORR
 CLASS: U

SHEET NUMBER 6

MICROSTATION FILE

A

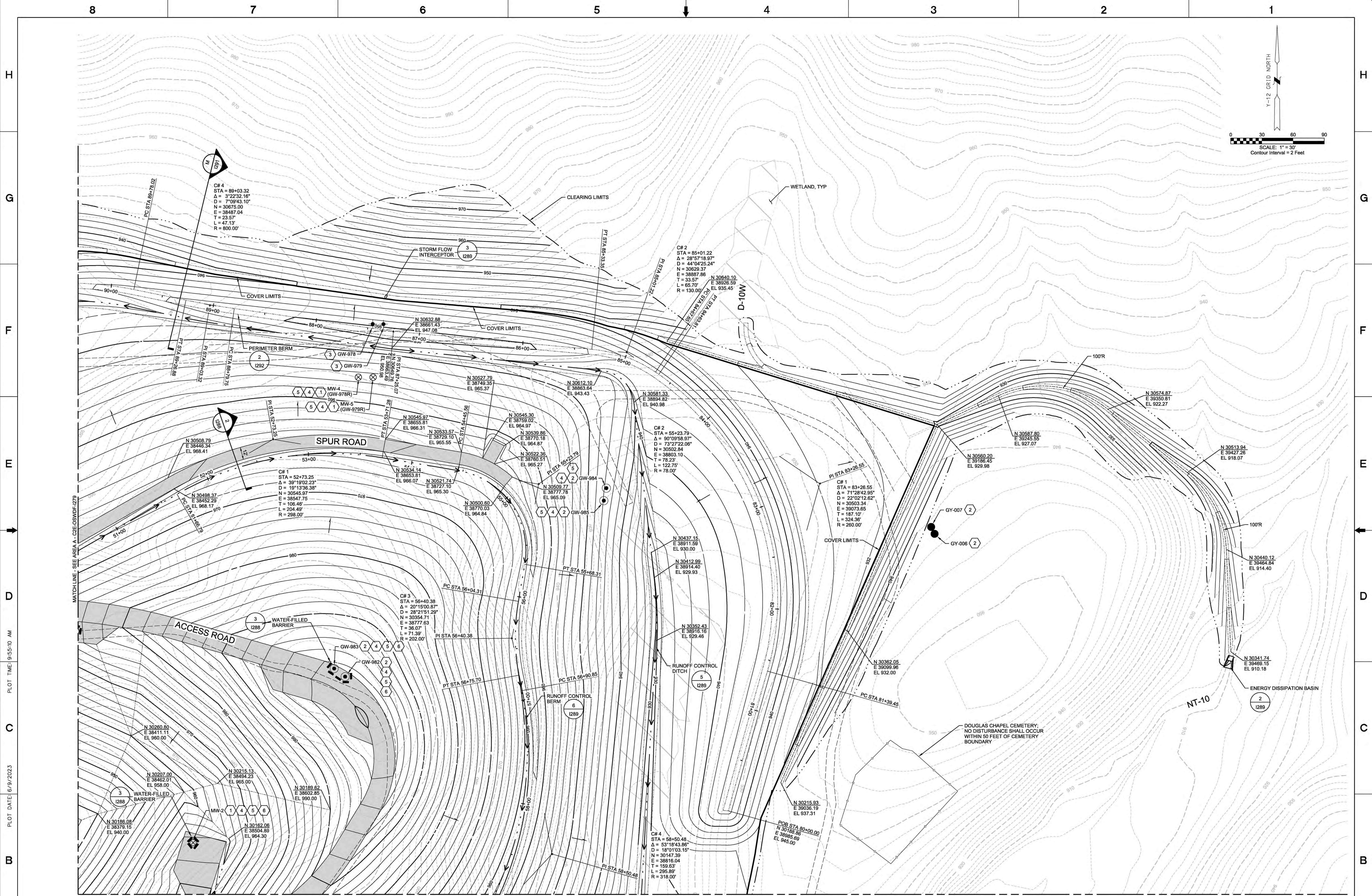

GENERAL NOTES		KEYNOTES	
A.	REFER TO TEMPORARY EROSION & SEDIMENT CONTROL PLAN, I273, FOR STORMWATER AND EROSION CONTROL MEASURES.	1.	NEW GROUNDWATER MONITORING WELL BY OTHERS
B.	ABANDONMENT, MODIFICATION OR INSTALLATION OF MONITORING WELLS, INCLUDING THE CONCRETE PAD AROUND EACH MONITORING WELL, TO BE COMPLETED PER UCOR SPECIFICATION SPG-0000-A05.	2.	SUBCONTRACTOR SHALL PRESERVE AND PROTECT ALL GROUNDWATER MONITORING WELLS TO REMAIN; EXTEND OR SHORTEN AS NECESSARY
		3.	ABANDONMENT OF GROUNDWATER MONITORING WELL BY OTHERS
		4.	ALL PROPOSED AND EXISTING MONITORING WELLS TO REMAIN WITHIN GWFD FOOTPRINT SHALL HAVE LINER PENETRATION INSTALLED PER DETAIL 4, DWG C2E-OSWDF-I288
		5.	DURING CONSTRUCTION, SUBCONTRACTOR SHALL PROVIDE WATER-FILLED BARRIERS AS TEMPORARY PROTECTION AROUND ALL NEW AND EXISTING MONITORING WELLS TO REMAIN
		6.	PERMANENT WATER-FILLED BARRIERS ARE REQUIRED AROUND THE NEW AND EXISTING MONITORING WELLS TO REMAIN ONLY WITHIN ACCESS ROADS AND TRAVELWAYS, AS SHOWN



DRW BY	DRG/ENGR	CHK	DM	PROJ ENGR	REV	DATE	DESCRIPTION	JA	FP	DM	DM	GP
J ASHWORTH												
F PARTON PE												
D MATLOCK PE												
D MATLOCK PE												
G PICKERLE PE												
ELECTRONIC SIGNATURES								6/09/23	ISSUED FOR CONSTRUCTION			
DRAWING REVISIONS												

SHEET NUMBER 13	
UCOR OAK RIDGE RESERVATION MANAGED FOR THE DEPARTMENT OF ENERGY UNDER CONTRACT DE-W-00087 OAK RIDGE TN 37830	
PROJECT RECORD NUMBER N/A	CONFIGURATION MANAGEMENT LEVEL N/A
PROJECT NAME: OSWDF GROUNDWATER FIELD DEMONSTRATION	
TITLE: FINISHED GRADING PLAN - AREA B	
CAD FILENAME C2E-OSWDFI280.dgn	BUILDING OSWDF
SITE ORR	CLASS U
SCALE AS SHOWN	DRAWING NUMBER C2E-OSWDF-I280
TYPE IN	REV 0

MICROSTATION FILE

A

KEYNOTES

- ENERGY DISSIPATION BASIN. SEE DETAIL 2 ON DWG C2E-OSWDF-I289

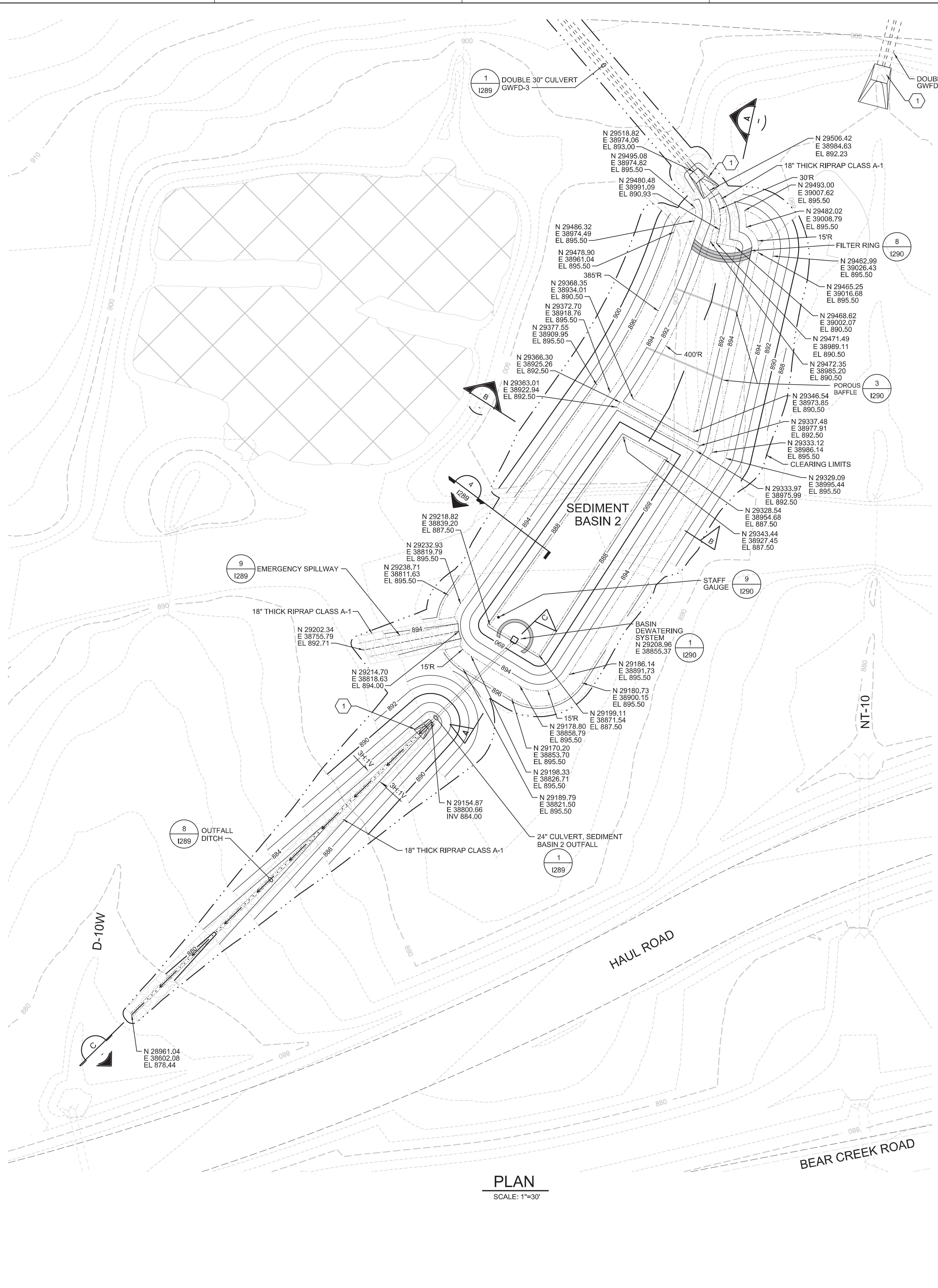
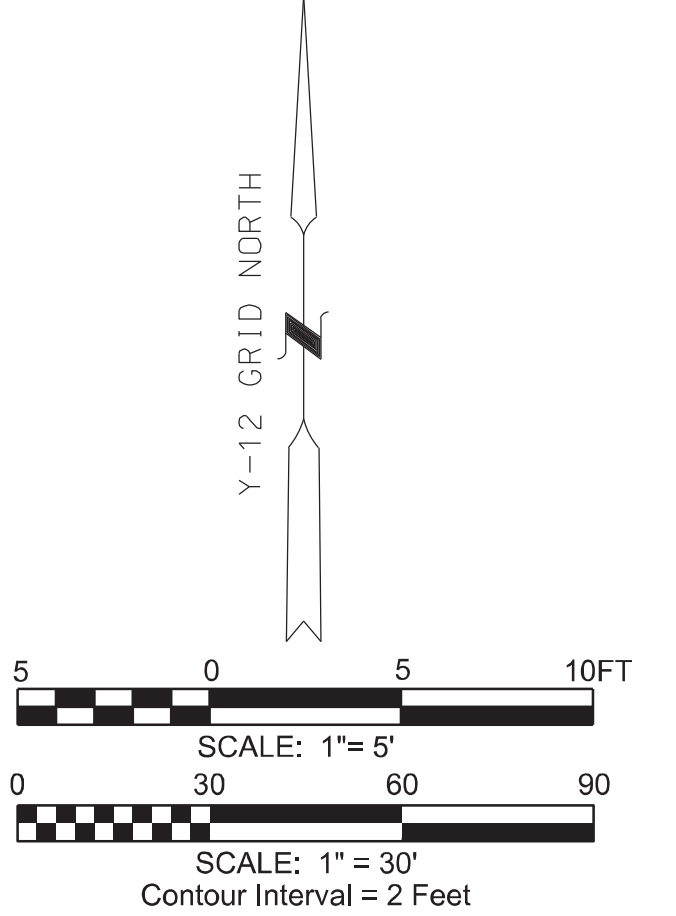

PLAN
SCALE: 1"=30"

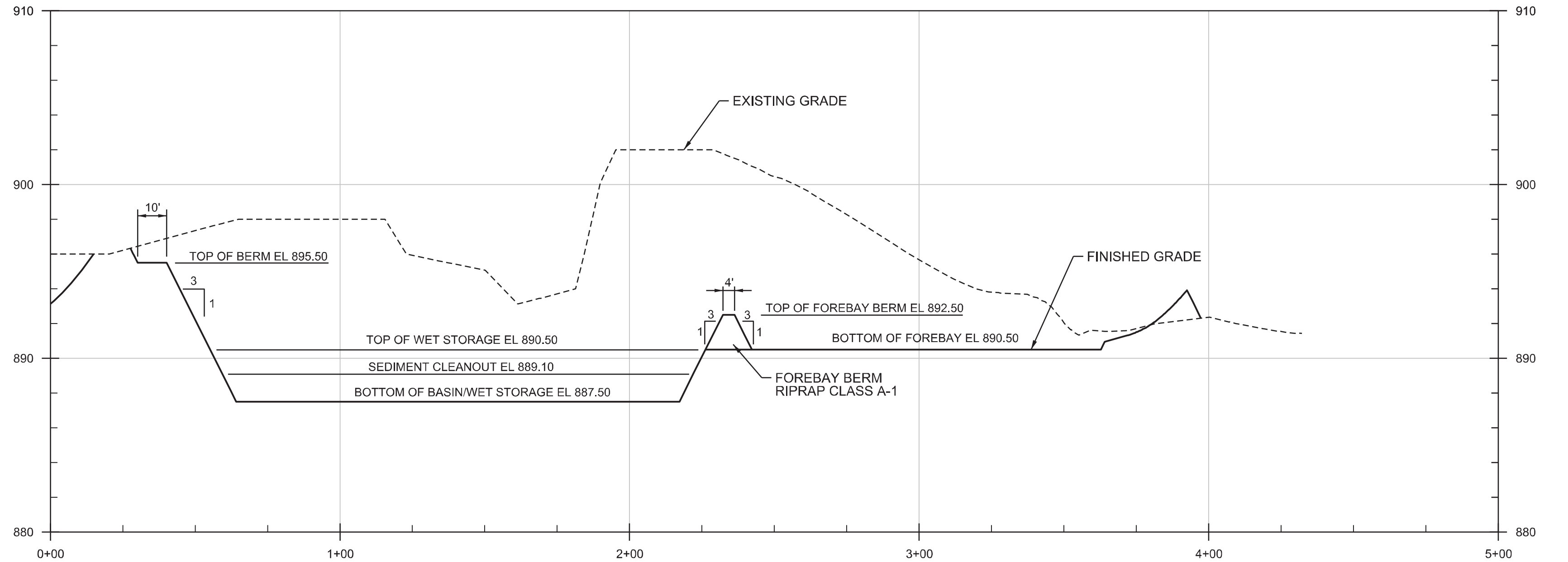

A SECTION
SCALE: 1"=30" HORIZ
1"=5" VERT

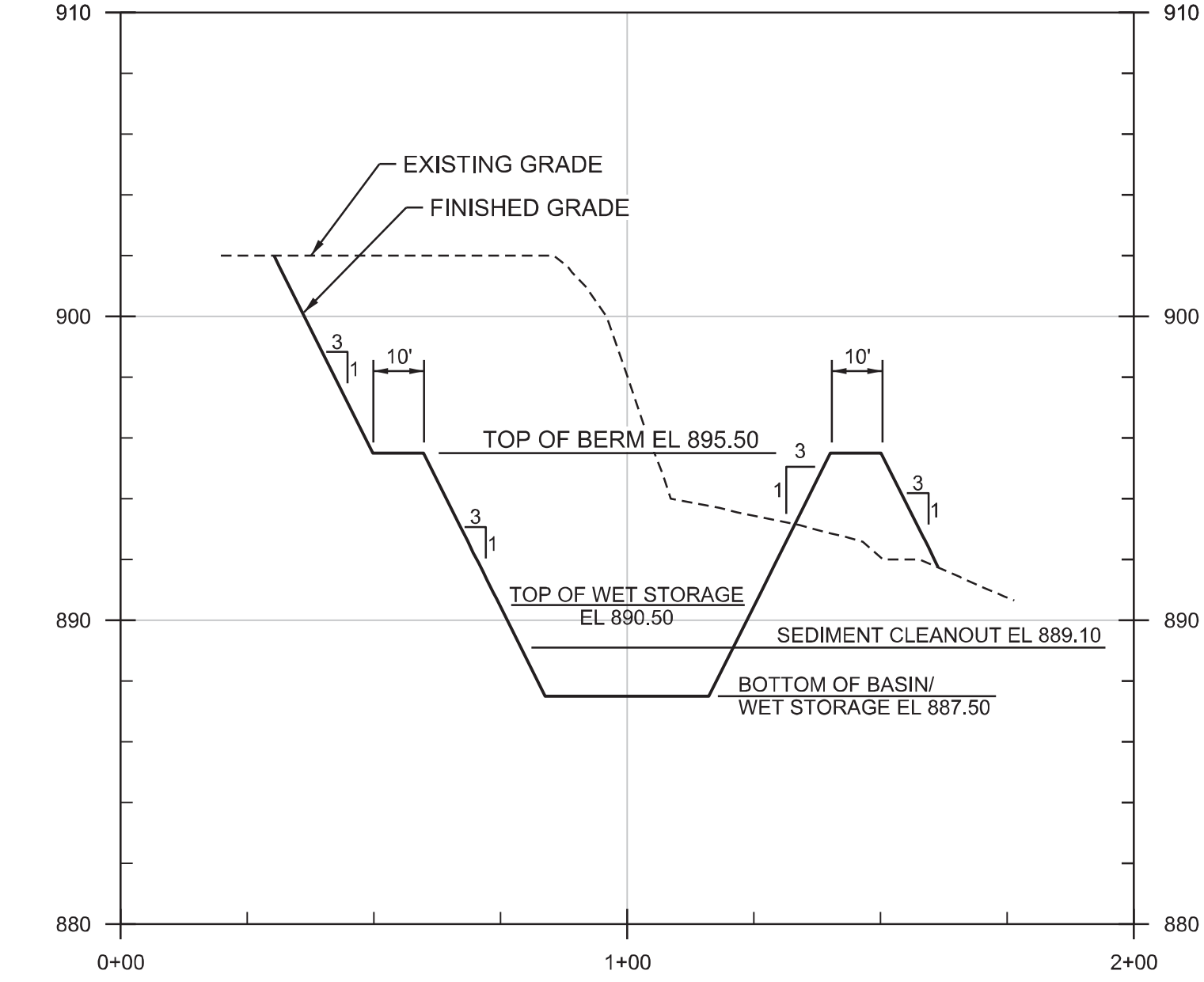

B SECTION
SCALE: 1"=30" HORIZ
1"=5" VERT

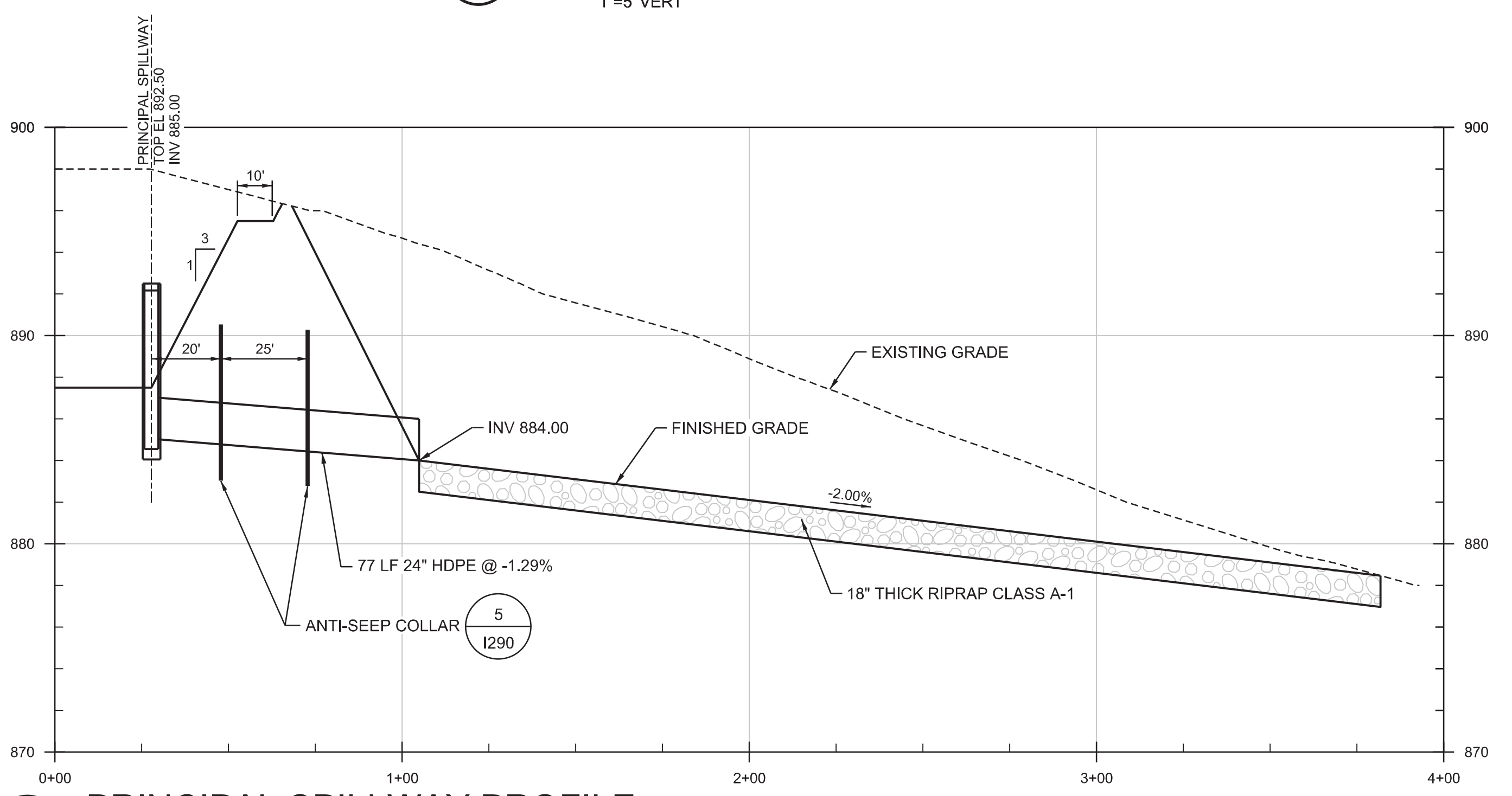

C PRINCIPAL SPILLWAY PROFILE
SCALE: 1"=30" HORIZ
1"=5" VERT



DRW BY: J ASHWORTH		Checked by: Jimmy Ashworth	Approved by: Frank Parton	Checked by: David Matlock	Approved by: David Matlock	Checked by: Greg Pickrel	Approved by: Greg Pickrel	DATE: 6/09/23	ISSUED FOR CONSTRUCTION	JA	FP	DM	DM	GP
ENGR CHK: D MATLOCK		Checked by: David Matlock	Approved by: David Matlock	Checked by: David Matlock	Approved by: David Matlock	Checked by: David Matlock	Approved by: David Matlock	DATE: 6/09/23	ISSUED FOR CONSTRUCTION	JA	FP	DM	DM	GP
ENGR DM: D MATLOCK		Checked by: David Matlock	Approved by: David Matlock	Checked by: David Matlock	Approved by: David Matlock	Checked by: David Matlock	Approved by: David Matlock	DATE: 6/09/23	ISSUED FOR CONSTRUCTION	JA	FP	DM	DM	GP
PRJ ENGR: G PICKEREL		Checked by: Greg Pickrel	Approved by: Greg Pickrel	Checked by: Greg Pickrel	Approved by: Greg Pickrel	Checked by: Greg Pickrel	Approved by: Greg Pickrel	DATE: 6/09/23	ISSUED FOR CONSTRUCTION	JA	FP	DM	DM	GP

PROJECT RECORD NUMBER: N/A		CONFIGURATION MANAGEMENT LEVEL: N/A	
PROJECT NAME: OSWDF GROUNDWATER FIELD DEMONSTRATION			
TITLE: SEDIMENT BASIN 2 ENLARGED PLAN			
CAD FILENAME: C2E-OSWDF-I286.dgn	BUILDING: OSWDF	SITE: ORR	CLASS: U
SCALE: AS SHOWN	TYPE: IN	DRAWING NUMBER: C2E-OSWDF-I286	REV: 0

SHEET NUMBER 19

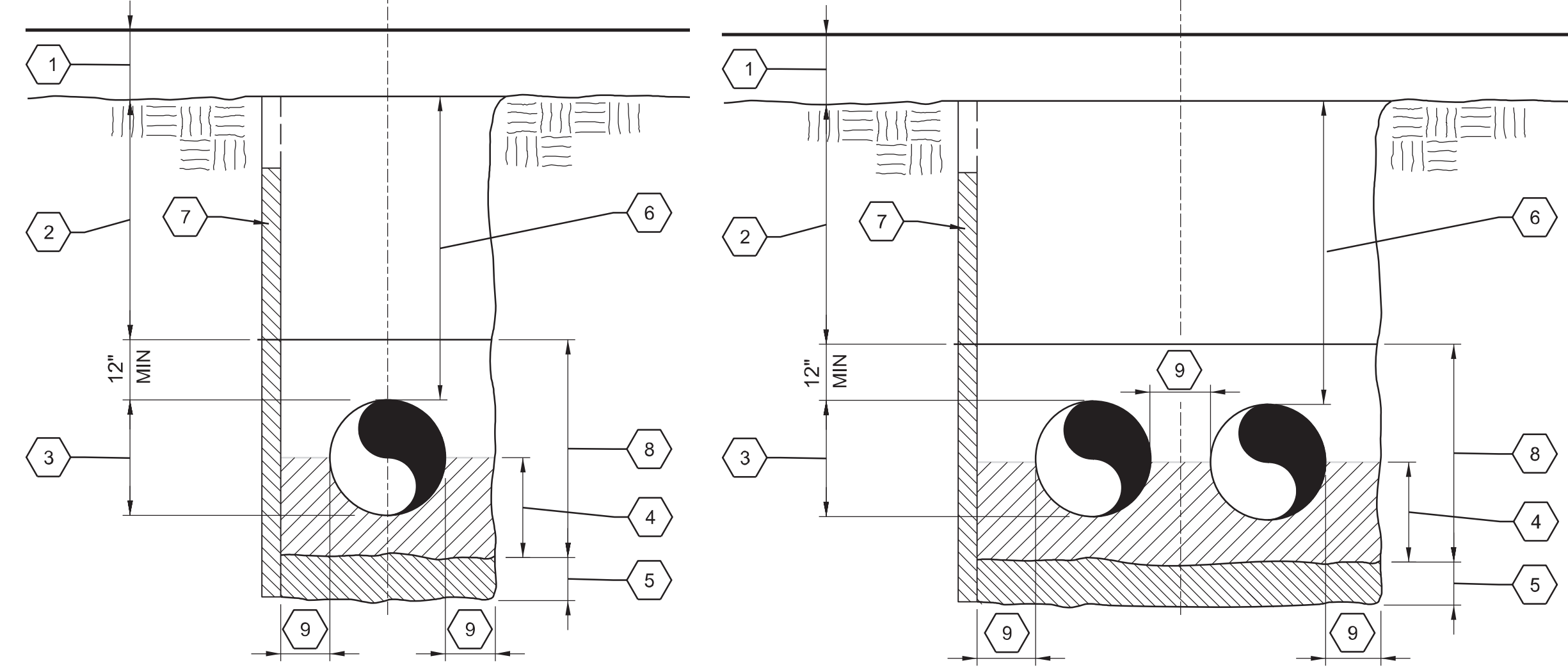

SINGLE PIPE

DOUBLE PIPE

KEYNOTES

1. NEW SURFACING, OR SURFACE RESTORATION, SEE PLANS
2. TRENCH BACKFILL ABOVE PIPE ZONE
3. PIPE OUTSIDE DIAMETER
4. PIPE BEDDING MATERIAL
5. TRENCH STABILIZATION WHERE REQUIRED
6. DEPTH OF COVER
7. SHORING
8. PIPE ZONE
9. 1/2 PIPE DIAMETER

NOTES:

1. ALL PIPES SHALL HAVE A CONSTANT SLOPE BETWEEN INVERT ELEVATIONS.
2. MINIMUM ALLOWABLE CLEARANCE BETWEEN PIPES AT CROSSINGS SHALL BE 3". CONTROLLED DENSITY FILL SUPPORT IS REQUIRED.

1 PIPE TRENCH
NTS

I281
I282
I285
I286

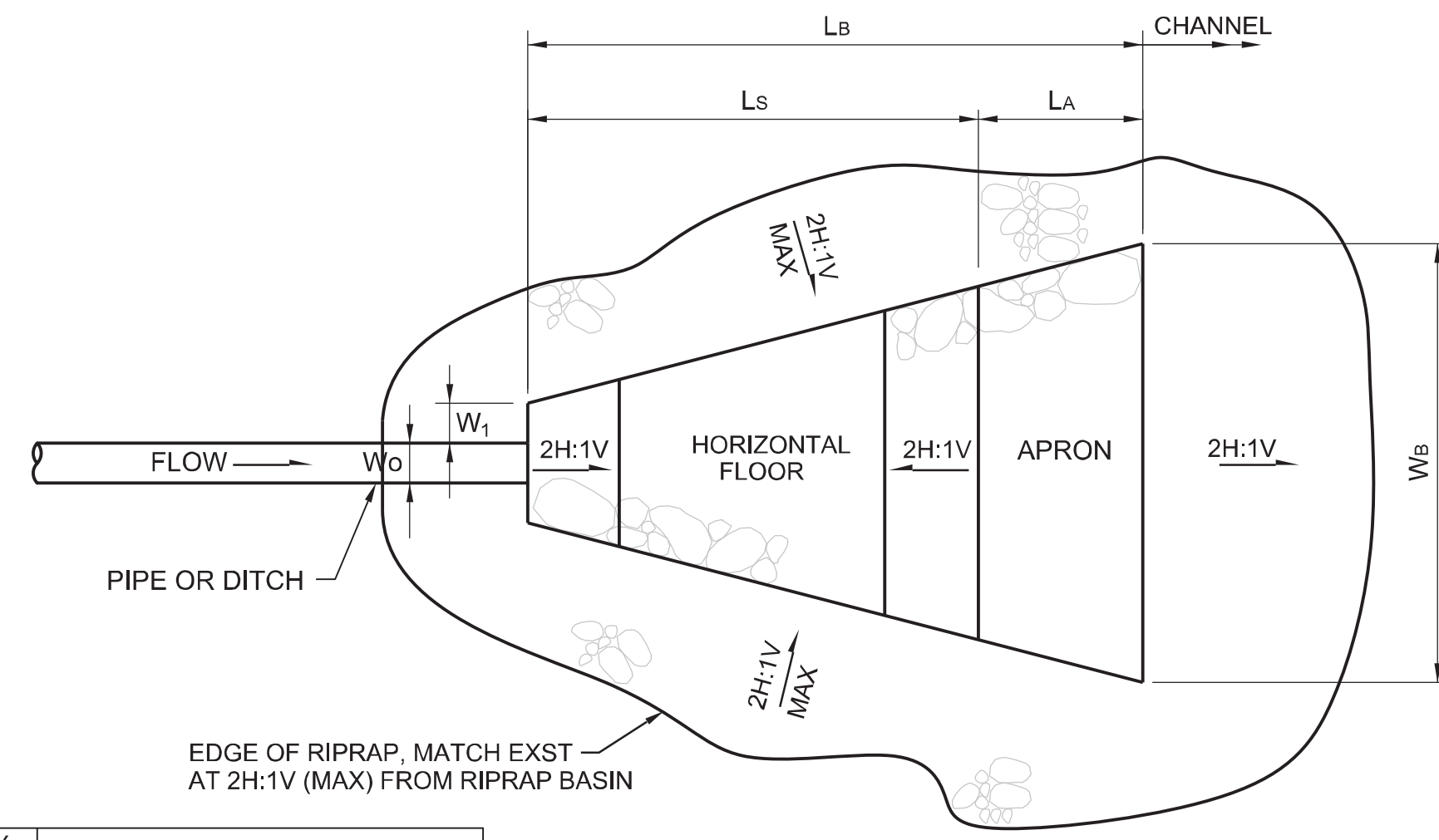

PLAN

ENERGY DISSIPATOR	Hs	Ls	Lx	Lb	Wo	Wb	D	W1
ALL	1'	10'	5'	15'	15'	1.5	1/2 Wc	

* ALL DIMENSIONS IN UNITS OF FEET, UNLESS OTHERWISE INDICATED
** SEE NOTE 2

NOTES:

1. ALL RIPRAP SHALL BE CLASS A-1 AS DEFINED IN SPECIFICATION SECTION 31 37 00 RIPRAP.
2. Wo IS DEFINED AS THE CULVERT DIAMETER OR BOTTOM WIDTH OF THE DITCH THAT DISCHARGES INTO THE ENERGY DISSIPATOR.
3. CAREFULLY PLACE RIPRAP LAYER ON TOP OF SEPARATION GEOTEXTILE WITHIN LIMITS OF ENERGY DISSIPATOR.

SECTION

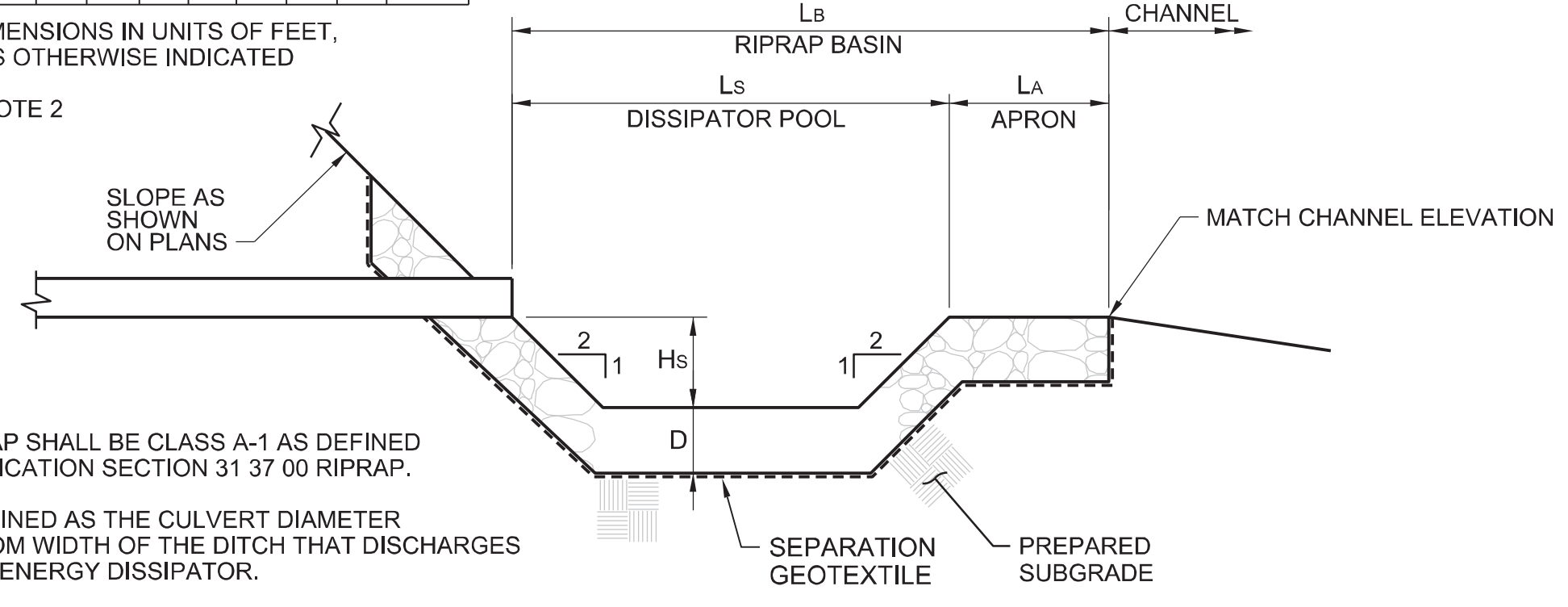

2 ENERGY DISSIPATION BASIN
NTS

I273
I280
I285
I286

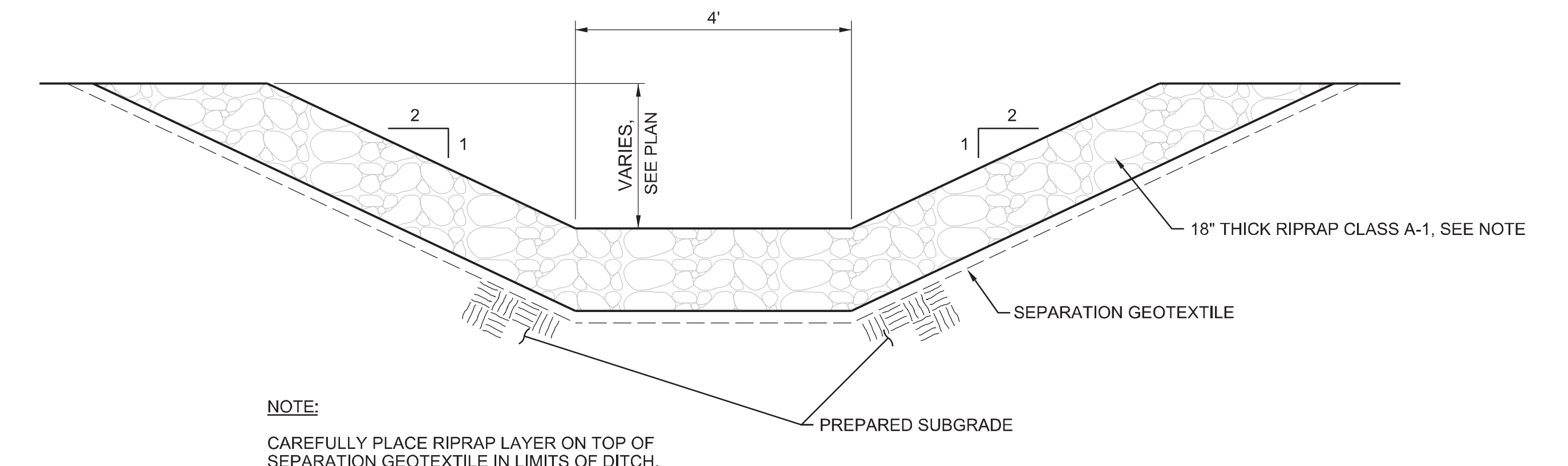

3 STORM FLOW INTERCEPTOR
NTS

I279
I280
I284
I291

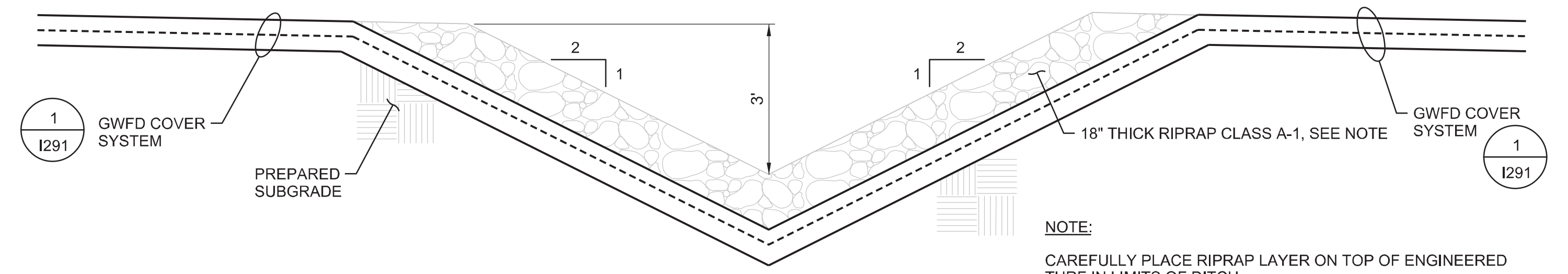

5 RUNOFF CONTROL DITCH
NTS

I279
I280
I281
I282
I283
I284
I291

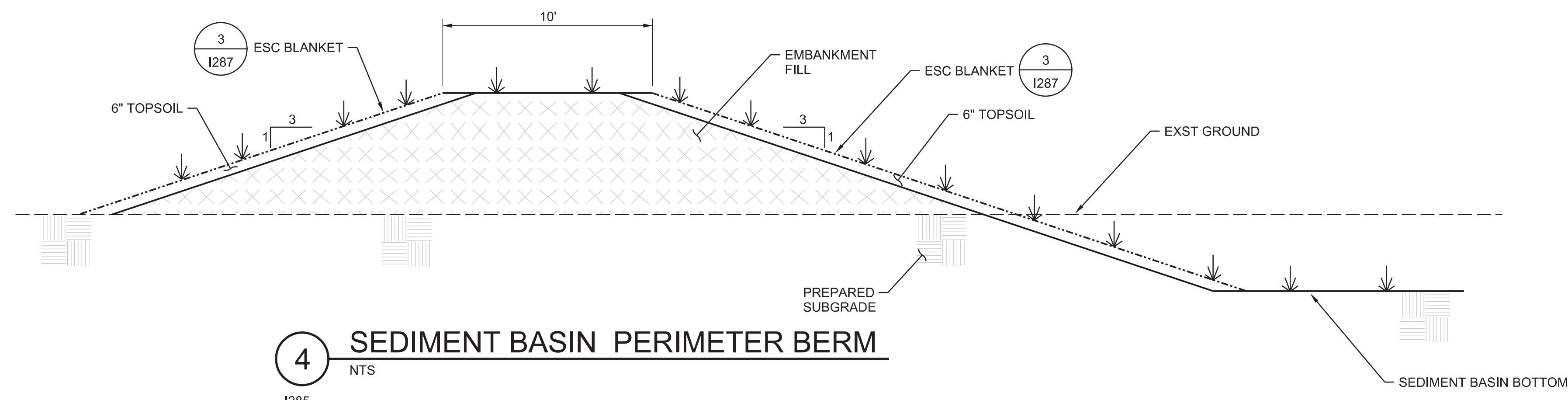

4 SEDIMENT BASIN PERIMETER BERM
NTS

I285
I286

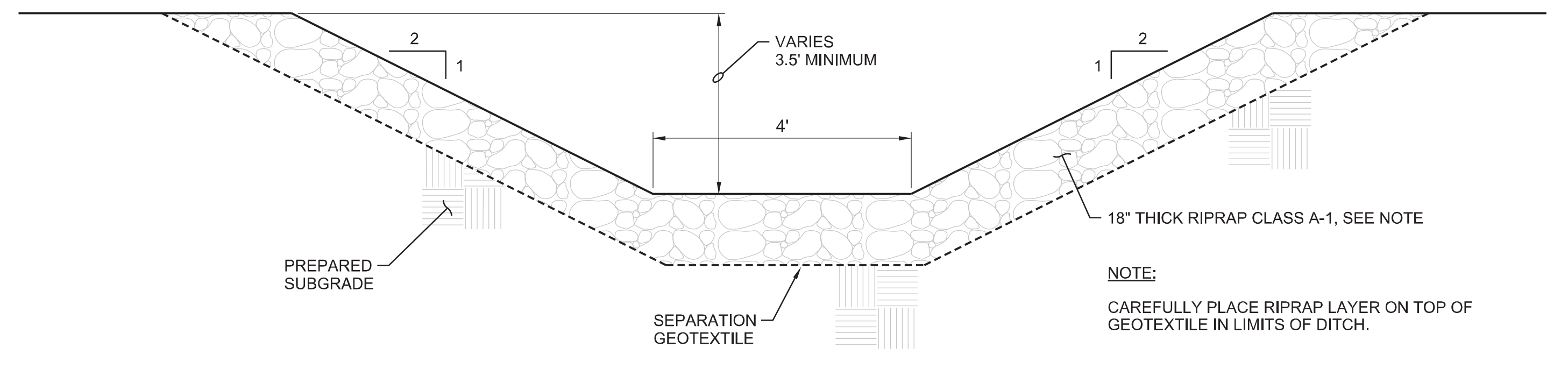

7 TRAPEZOIDAL DITCH
NTS

I281
I283

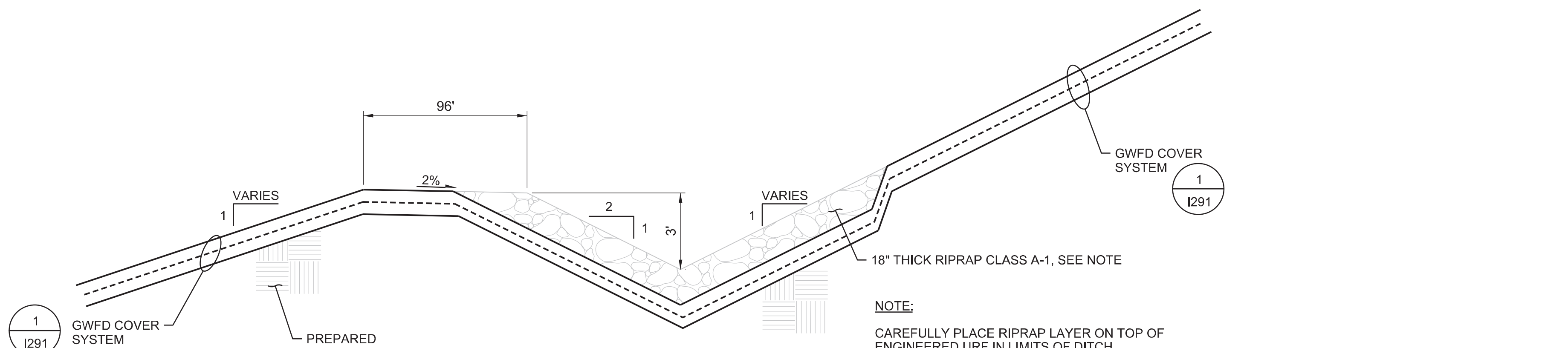

6 RUNOFF CONTROL BERM
NTS

I280
I281
I282
I283
I284

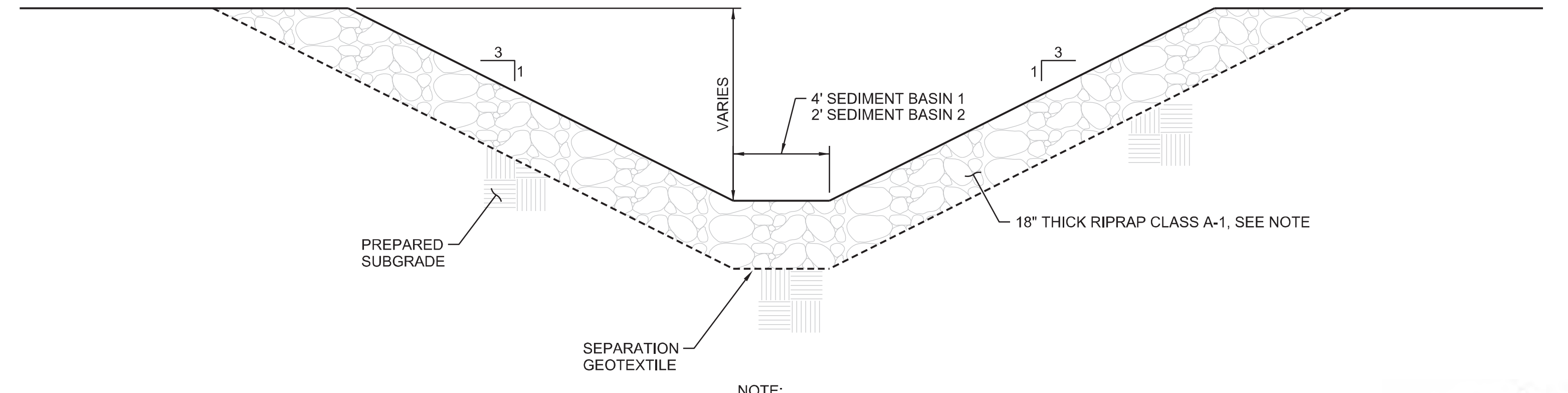

8 OUTFALL DITCH
NTS

I285
I286

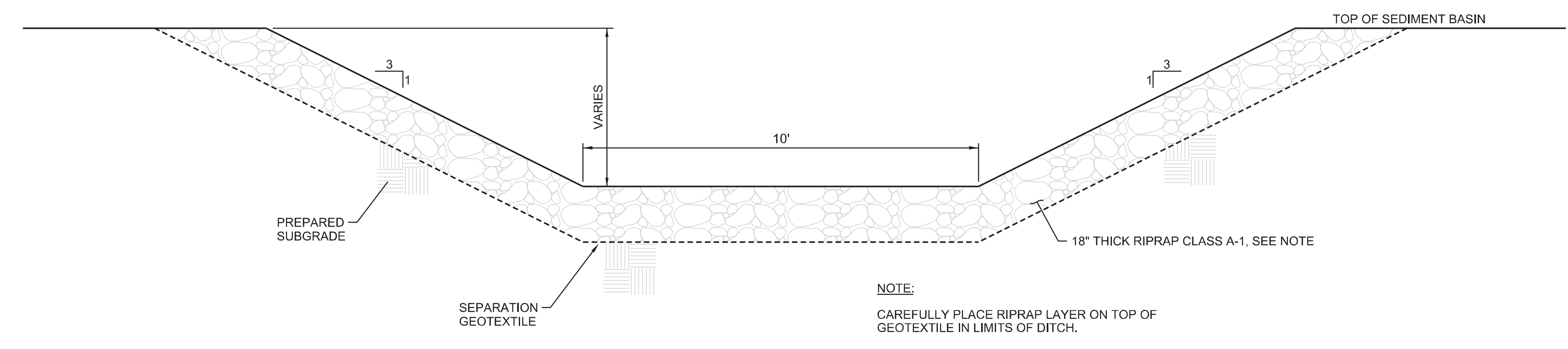

9 EMERGENCY SPILLWAY
NTS

I285
I286

DRW BY	J ASHWORTH	Jimmy Ashworth	Checked by Jimmy Ashworth
DRG	F PARTON PE	Frank Parton	Checked by Frank Parton
ENGR	D MATLOCK PE	David Matlock	Checked by David Matlock
CHK	D MATLOCK PE	David Matlock	Checked by David Matlock
DM	D MATLOCK PE	David Matlock	Checked by David Matlock
PRJ ENGR	G PICKEREL PE	Greg Pickarel	Checked by Greg Pickarel

REV	DATE	DESCRIPTION	DRW BY	ENGR	CHK	DM	PRJ ENGR
△	6/09/23	ISSUED FOR CONSTRUCTION	JA	FP	DM	DM	GP

PROJECT RECORD NUMBER	N/A	CONFIGURATION MANAGEMENT LEVEL	N/A
PROJECT NAME:	OSWDF GROUNDWATER FIELD DEMONSTRATION		
TITLE:	STORMWATER SECTIONS AND DETAILS - 1		
CAD FILENAME	C2E-OSWDF1289.dgn	BUILDING	OSWDF
SCALE	AS SHOWN	TYPE	IN
DRAWING NUMBER	C2E-OSWDF-1289	CLASS	U
REV	0	REV	0



SHEET NUMBER 22

UCOR OAK RIDGE RESERVATION
MANAGED FOR THE DEPARTMENT OF ENERGY
UNDER CONTRACT DE-M-00067
OAK RIDGE, TN 37830

KEY TECHNICAL SPECIFICATIONS

This page intentionally left blank.

**SPECIFICATION
 FOR
 SECTION 31 25 00
 TEMPORARY EROSION AND SEDIMENT CONTROL
 GROUNDWATER FIELD DEMONSTRATION (GWFD)**

		JOB NO.	
		SPECIFICATION NO.	SPC-OSWDF-I305
		SHEET	1 of 20
	Name	Signature	Date
Originator	Ken Oliver, PE		6/06/2023
Checker	David Matlock, PE		6/06/2023
Additional Reviewer	Butch Parton, PE		6/06/2023
Additional Reviewer			
Project Engineer	Greg Pickerel, PE		

Revision History		
Rev. No.	Reason For Revision	Date
0	Issued For Construction	6/06/2023



Form-362 (02/23) Rev. 3
 PROC-DE-1007

SECTION 31 25 00
TEMPORARY EROSION AND SEDIMENT CONTROL

PART 1: GENERAL

1.01 DESCRIPTION

- A. This section includes temporary control measures for slope protection and controls to reduce erosion, sedimentation, and water pollution through the use of sediment basins, fiber mats, erosion control matting, mulches, grasses, temporary silt fences, and other control devices.
- B. The Subcontractor shall anticipate future conditions and transitions as construction progresses to satisfy erosion and sediment control measures through each phase of project development.
- C. Activities shall conform to the Tennessee Erosion and Sediment Control Handbook and to the construction drawings. In the event of a conflict, the more stringent requirement shall apply.
- D. The Subcontractor shall also comply with erosion and sediment control measures that are listed within Stormwater Management Requirements for OSWDF Groundwater Field Demonstration.

1.02 DEFINITIONS

- A. Anti-Seep Collar: See the definition in Section 33 40 00, Storm Drainage System.
- B. Check Dam: A temporary structure made of riprap or gravel across a ditch, that can reduce velocities in small channels and provide moderate sediment-filtering capability.
- C. Construction Exit: A compacted stone pad to remove mud and soil from construction vehicles prior to entering an existing road in use.
- D. Erosion Control Matting: A biodegradable product designed to stabilize areas with moderate erosion control and/or low flows. These mats help to provide stabilization, support and coverage around hillsides, banks, and shorelines. These mats protect soil against wind and water erosion by reducing raindrop impact and slowing runoff as it flows across the surface.
- E. Filter Ring: A temporary sediment control, constructed of riprap and aggregate, that is placed around a storm drainage inlet to reduce flow velocities and to serve as a forebay to a sediment basin.
- F. Filter Sock: A tube-shaped manufactured geotextile that can be used to reduce flow velocities and/or filter sediment on a slope or in a small drainage channel.

- G. Gabion Basket: A rectangular box-shaped mesh basket, made with galvanized wire or welded wire, with engineered properties, and a controlled hole shape/size to retain aggregate or riprap materials.
- H. Hydroseed or Hydromulch: A hydraulically-applied mixture containing mulch, tackifiers, soil amendments and/or seed in a water-based slurry, applied to slopes to establish vegetation. Can be used for seeding, mulching, and bonded fiber matrix application.
- I. Jute Mesh: A tough, natural, biodegradable geotextile used to stabilize slopes and control soil erosion.
- J. Mulch: An organic material applied to the soil surface for protection or improvement of the area covered. Improvements include conservation of soil moisture, improving fertility and health of the soil, reducing weed growth, and enhancing the visual appeal of the area.
- K. Porous Baffle: Barriers within a sediment trap or sediment basin to reduce the velocity and turbulence of storm water flowing through the measure. Porous baffle can be constructed from coir erosion blanket, coir mesh or jute fabric (typical 20 oz/yd²) with wire backing and steel posts.
- L. Sediment Basin: A temporary sediment storage area with a dam embankment, sediment forebay, dewatering mechanism, a designed outlet detention structure with principal spillway, an emergency spillway, a permanent pool, and scour protection at the outlets.
- M. Silt Fence: A temporary sediment control device used on construction sites to protect water quality in nearby streams, rivers, lakes, and seas from sediment in stormwater runoff.
- N. Straw Wattles: Also known as straw worms, bio-logs, and straw noodles installed in a shallow trench forming a continuous barrier along the contour (across the slope) to intercept water running down a slope. Wattles are a cost-effective erosion control solution designed to curb the effects of medium to high velocity stormwater runoff.
- O. Temporary Seeding: Temporary vegetation to be applied to disturbed or graded areas (especially slopes) whenever - a) grading activities have been temporarily suspended for more than three weeks, or b) whenever Permanent Seeding is unable to be applied per the requirements of Section 32 92 19.
- P. Turf Reinforcing Mats (TRM): A rolled erosion control product used in hydraulic applications, such as high flow ditches and channels, steep slopes, stream banks, and shorelines, where erosive forces may exceed the limits of natural, unreinforced vegetation or in areas where limited vegetation establishment is anticipated.

1.03 REFERENCES

- A. American Association of State Highway Transportation Officials (AASHTO):
 - 1. AASHTO M 252, Standard Specification for Corrugated Polyethylene Drainage Pipe

- B. ASTM International (ASTM):
 - 1. ASTM A974, Standard Specification for Welded Wire Fabric Gabions and Gabion Mattresses (Metallic-Coated or Polyvinyl Chloride ((PVC) Coated)
 - 2. ASTM A975, Standard Specification for Double-Twisted Hexagonal Mesh Gabions and Revet Mattresses (Metallic-Coated Steel Wire or Metallic-Coated Steel Wire with Poly (Vinyl Chloride) (PVC) Coating)
 - 3. ASTM D4355, Standard Test Method for Deterioration of Geotextiles by Exposure to Light, Moisture and Heat in a Xenon Arc Type Apparatus
 - 4. ASTM D4491, Standard Test Methods for Water Permeability of Geotextiles by Permittivity
 - 5. ASTM D4632, Standard Test Method for Grab Breaking Load and Elongation of Geotextiles
 - 6. ASTM D4751, Standard Test Method for Determining Apparent Opening Size of a Geotextile
 - 7. ASTM D6459, Standard Test Method for Determination of Rolled Erosion Control Product (RECP) Performance in Protecting Hillslopes from Rainfall-Induced Erosion
 - 8. ASTM D6460, Standard Test Method for Determination of Rolled Erosion Control Product (RECP) Performance in Protecting Earthen Channels from Stormwater-Induced Erosion
 - 9. ASTM D6475, Standard Test Method for Measuring Mass Per Unit Area of Erosion Control Blankets
 - 10. ASTM D7322, Standard Test Method for Determination of Rolled Erosion Control Product (RECP) Ability to Encourage Seed Germination and Plant Growth Under Bench-Scale Conditions
 - 11. ASTM D7367, Standard Test Method for Determining Water Holding Capacity of Fiber Mulches for Hydraulic Planting

- C. Stormwater Management Requirements for OSWDF Groundwater Field Demonstration; UCOR-5620 (prepared by the Contractor)

- D. Tennessee Department of Environment and Conservation (TDEC):
 - 1. Erosion and Sediment Control Handbook, Latest edition
- E. Tennessee Department of Transportation (TDOT):
 - 1. Standard Specifications for Road and Bridge Construction, Latest edition
- F. U.S. Department of Agriculture, Natural Resources Conservation Service:
 - 1. Urban Hydrology for Small Watersheds; 1986. Technical Release 55.

1.04 SUBMITTALS

- A. The following documents shall be submitted to the Subcontract Technical Representative (STR) in accordance with the requirements of Exhibit I of the Subcontract.
 - 1. Submit a Stormwater Management Requirements Implementation Plan in accordance with the construction drawings, with a construction schedule for implementing the erosion and sediment controls for each construction phase. Obtain Contractor's approval of the SMRI Plan and schedule before any work begins. Obtain Contractor's approval for any modifications to the SMRI Plan before any work continues.
 - 2. Product data for each material, along with installation procedures, to show that manufactured erosion control products are in accordance with the construction drawings, these specifications, and the TDEC Erosion and Sediment Control Handbook.
 - 3. Product data for materials, along with installation procedures, to show that sediment basin features (such as Staff Gauge and Gabions) are in accordance with the construction drawings, these specifications, and the TDEC Erosion and Sediment Control Handbook.
 - 4. Product data and delivery tickets for aggregate and riprap materials that are delivered as part of erosion and sediment controls installation.
 - 5. Hydroseed and Hydromulch blend product data sheets, when applicable.

1.05 DELIVERY, STORAGE, AND HANDLING

- A. Delivery, storage, and handling shall be in accordance with the manufacturer's recommendations.
- B. Stored materials shall be protected from damaging conditions to include sunlight, rain, extreme temperatures, and moist conditions.

1.06 QUALITY ASSURANCE

- A. Keep detailed records of all activities, correspondence, inspections, maintenance work, and related documents until project work defined by the contract and construction drawings has been accepted.
- B. Comply with the project requirements for inspection frequency, repairs, and recordkeeping.

1.07 STORMWATER MANAGEMENT REQUIREMENTS IMPLEMENTATION PLAN

- A. Subcontractor shall develop and submit a Stormwater Management Requirements Implementation Plan (SMRI Plan). Additional or revised erosion and sediment control features may be required depending on Subcontractor's methods of operation and construction schedule.
- B. For each phase of the scheduled work, indicate on the SMRI Plan all measures necessary for erosion and sediment control to minimize clearing, stabilize exposed soil, divert or temporarily store flows, limit runoff from exposed areas, and filter transported sediment. Include all temporary access routes and slopes that are not identified in construction drawings. Refer to TDEC Erosion and Sediment Control Handbook for further guidance.
- C. Elements of the SMRI Plan:
 - 1. Specifically address work items listed within the Contractor's document, Stormwater Management Requirements for OSWDF Groundwater Field Demonstration. Include the inspections and maintenance activities that will be required for the post-construction maintenance period for the duration stated in the Construction Subcontract.
 - 2. Implementation Schedule for the sequence of major construction phases.
 - 3. Matrix of stormwater installation activities, erosion controls, sediment controls, and maintenance activities that will take place during each major construction phase.
 - 4. Site Map for each major construction phase to include:
 - a. Active work areas for site clearing, grading, roads installation, drainage installation, and closure turf installation.
 - b. Drainage patterns for each phase.
 - c. Sensitive areas such as natural wetlands and cemetery.
 - d. Stockpile locations for each phase.
 - e. Laydown areas for each phase.
 - f. Parking areas for employee vehicles and for construction equipment.
 - g. Locations of sediment and erosion controls for each phase.

- D. Approval and updates to SMRI Plan:
1. The Subcontractor's SMRI Plan and implementation schedules must be prepared by a competent individual. Furnish a signed copy of the SMRI Plan with the individual's name, title, state certifications, and employing firm if different than Subcontractor's firm.
 2. Do not begin any site activities that have potential to cause erosion or sediment movement until the SMRI Plan and implementation schedules are approved by the Subcontract Technical Representative (STR).
 3. Keep a copy of the approved SMRI Plan with updated changes onsite during all construction activities, available to the Subcontract Technical Representative (STR) for inspection.
 4. Continually update the SMRI Plan and schedules as needed for unexpected storm or other events to ensure that sediment-laden water does not leave the construction site. Add approved changes to the SMRI Plan no later than 24 hours after implementation.
- E. Preventing erosion, and controlling runoff, sedimentation, and non-stormwater pollution, will require the Subcontractor to perform temporary work items that may include, but are not limited to these items.
1. Providing ditches, berms, culverts, and other measures to control surface water.
 2. Building dams, settling basins, energy dissipaters, and other measures, to control downstream flows.
 3. Controlling underground water found during construction.
 4. Covering or otherwise protecting slopes until permanent erosion control measures are working.
- F. Subcontract Technical Representative (STR) may require additional temporary control measures if it appears that unacceptable stormwater pollution or erosion may result from weather, nature of the materials, or progress on the work.
- G. When natural elements rut or erode the slope, restore and repair damage with eroded material where possible, and remove and dispose of any remaining material found in ditches and culverts.
- H. Install all erosion and sediment control devices prior to any ground-disturbing activity. Do not expose more erodible earth than necessary during clearing, grubbing, excavation, borrow, or fill activities without stabilizing open areas. Contractor's Engineer may increase or decrease the limits based on project conditions. Cover inactive areas of erodible earth, whether at final grade or not, as soon as possible using an approved soil-covering practice. Phase the clearing and grading activities to the maximum extent practical to prevent exposed inactive areas from becoming a source of erosion.

- I. Sediment Basin Construction: Construct before beginning other grading and excavation work in the area that drains into that pond. Install temporary conveyances concurrently with grading in accordance with the SMRI Plan so that newly graded areas drain to the pond as they are exposed.
- J. Pollution Control: Use BMPs to prevent or minimize stormwater exposure to pollutants from spills; vehicle and equipment fueling, maintenance, and storage; other cleaning and maintenance activities; and waste handling activities. These pollutants include fuel, hydraulic fluid, and other oils from vehicles and machinery, as well as debris, leftover paints, solvents, and glues from construction operations. Implement the following BMPs when applicable:
 - 1. Written spill prevention and response procedures.
 - 2. Employee training on spill prevention and proper disposal procedures.
 - 3. Spill kits in all vehicles.
 - 4. Regular maintenance schedule for vehicles and machinery.
 - 5. Material delivery and storage controls.
 - 6. Training and signage.
 - 7. Covered storage areas for waste and supplies.
- K. If the Contractor orders other project work suspended, the Subcontractor shall continue to control erosion, pollution, and runoff during the shutdown.

1.08 SMRI MANAGER

- A. Identify the SMRI Manager at the preconstruction discussions and in the SMRI Plan. The SMRI Manager shall have certification in construction site erosion and sediment control from a course approved by the Contractor.
- B. The SMRI Manager shall implement and update the SMRI Plan throughout the construction project. Install and maintain all temporary erosion and sediment control Best Management Practices (BMPs) included in the SMRI Plan to assure continued performance of their intended functions. Damaged or inadequate BMPs shall be corrected immediately.
- C. The SMRI Manager and qualified representatives shall inspect all areas disturbed by construction activities, all onsite erosion and sediment control BMPs, all stormwater discharge points, and all temporarily stabilized inactive sites. Complete erosion and sediment control inspection forms developed as part of SMRI Plan for each inspection and submit a copy to Subcontract Technical Representative (STR) no later than end of the next working day following inspection.
- D. Personnel Training: Prior to commencement of construction, applicable inspection personnel who are identified in SMRI Plan must understand procedures for conducting inspections, recording findings, and taking corrective actions.

PART 2: PRODUCTS

2.01 MATERIALS

- A. The Subcontractor shall furnish all materials, tools, and equipment to deliver, install and maintain erosion and sediment control measures.
- B. Other erosion and sediment control devices are described in the TDEC Erosion and Sediment Control Handbook and in TDOT specifications.

2.02 CHECK DAMS

- A. Detail is shown on construction drawings, using TDOT Class A-1 riprap.

2.03 CONSTRUCTION EXIT

- A. Detail is shown on construction drawings. Construct a stabilized construction exit pad from TDOT #2 clean aggregate, placed at least 8 inches deep and not less than 50 feet long. Provide aggregate free of extraneous materials that may cause or contribute to track out.
- B. Place separation geotextile under the rock to prevent fine sediment from pumping up into the rock pad. See Section 32 05 19, Geotextile, for required geotextile properties.
- C. The use of constructed or manufactured steel plates with ribs (such as either shaker/rumble plates or corrugated steel plates) for construction entrance/exit access is allowable when approved by Subcontract Technical Representative.

2.04 EROSION CONTROL MATTING (BLANKET), BIODEGRADABLE

- A. Erosion control matting shall be made of natural plant fibers. Supply erosion control matting that satisfies the following requirements in Table 1 on next page.

2.05 EROSION CONTROL MATTING ANCHORING DEVICES

- A. Anchors can be 11-gauge biodegradable staples with at least 6 inches length by 1 inch width, or 12-inch minimum length wooden stakes, or as recommended by the erosion control matting manufacturer.

2.06 EROSION EEL

- A. A manufactured erosion control device cylinder using recycled materials (ground tire rubber). Does not require trenching into the soil for effectiveness. Does not require staking on flat surfaces. Use wood stakes on slopes and in areas of concentrated stormwater flow. Typical diameter = 9 to 10 inches.
- B. Wood Stakes: Untreated softwood species, 2-inch by 2-inch nominal dimension and 36 inches in length.

Table 1 Erosion Control Matting		
Properties	ASTM Test Method	Requirements
Protecting Slopes from Rainfall-Induced Erosion	D6459: Test in one soil type. Soil tested shall be sandy loam as defined by the NRCS Soil Texture Triangle.	Maximum C factor of 0.15 using Revised Universal Soil Loss Equation (RUSLE)
Dry Weight per Unit Area	D6475	0.36 lb/sq. yd. minimum
Performance in Protecting Earthen Channels from Stormwater-Induced Erosion	D6460: Test in one soil type. Soil tested shall be loam as defined by the NRCS Soil Texture Triangle.	1.0 lb./sq. ft. minimum
Seed Germination Enhancement	D7322	200 percent minimum
Netting, if present, shall be biodegradable with a life span not to exceed 1 year.		

2.07 FILTER RING

- A. Constructed of riprap, aggregate, and filter geotextile as specified on the construction drawings. Minimum height equal to 2 feet, with typical 2:1 side slopes.

2.08 FILTER SOCK

- A. Manufactured 12" diameter compost filter sock, typically photodegradable or biodegradable material but may be constructed of woven polypropylene. Use 2" x 2" wooden stakes or fasteners as recommended by manufacturer.

2.09 GABION BASKET

- A. Manufactured wire-mesh basket with either welded galvanized wire (per ASTM A974) or double-twisted galvanized wire that is PVC-coated (per ASTM A975). If stacking gabion units, firmly attach each level of gabion per manufacturer instructions. Submit manufacturer data sheets, product details, and the installation instructions for approval.
- B. Gabion Basket Infill: See Section 31 37 00, Riprap, for TDOT Class A-3 riprap material.

2.010 GEOTEXTILE

- A. Geotextiles shall consist only of long chain polymeric fibers or yarns formed into a stable network such that the fibers or yarns retain their position relative to each other during handling, placement, and design service life. At least 95 percent by

weight of the material shall be polyolefins or polyesters. The material shall be free from defects or tears. Geotextile shall also be free of any treatment or coating which might adversely alter its hydraulic or physical properties after installation.

- B. Erosion control geotextile properties shall be as specified for Nonwoven Separation Geotextile in Section 31 05 19, Geotextile.
- C. Silt fence geotextile properties shall be as described in Table 2.

Table 2 Geotextile for Temporary Silt Fence			
Geotextile Property	ASTM Test Method	Geotextile Property Requirements	
		Unsupported Between Posts	Supported Between Posts with Wire or Polymeric Mesh
AOS	D4751	U.S. No. 30 max. for silt wovens, U.S. No. 50 for all other geotextile types, U.S. No. 100 min.	
Water Permittivity	D4491	0.2 sec ⁻¹ min.	
Grab Tensile Strength, in machine and x-machine direction	D4632/ D4632M	180 lb min. in machine direction, 100 lb min. in x-machine direction	100 lb min.
Grab Failure Strain, in machine and x-machine direction	D4632/ D4632M	30% max. at 180 lb or more	
Ultraviolet (UV) Radiation Stability	D4355	70% strength retained min., after 500 hours in xenon arc device	

2.011 GRAVEL FILTER OR WOOD CHIP BERM

- A. Rock Material Used for Filter Berms: Clean 3/4-inch rock, with no recycled materials.
- B. Wood Chips Used for Wood Chip Berm: As specified in paragraph 2.024.

2.012 HYDROMULCH

- A. Moderate-duration bonded fiber matrix mulch, equivalent to HECF Type 2, with a 3-to-6 month duration, with binders premixed into the mulch material mixture. Typical hydromulch shall be TurboTurf Hydroseeding Mulch, or approved equal.

2.013 OUTLET PROTECTION

- A. Riprap sizes and dimensions as specified on details on construction drawings. See Section 31 37 00, Riprap, for riprap materials.

2.014 POROUS BAFFLE

- A. Porous fabric/matting material shall be coir erosion blanket, coir mesh, or jute fabric of adequate width per drawing detail. Use steel posts and industrial netting, normally intended for use with silt fences, as the framework. Use 9-gauge wire fasteners or plastic ties in sufficient quantities. Use continuous rope or wire cable at top of baffle to prevent sagging.

2.015 PRECAST CONCRETE DETENTION STRUCTURE

- A. The precast concrete drainage outlet structure for a designed sediment basin is described in Specification 33 40 00, and shown on construction drawing details.

2.016 SEDIMENT CONTROL BARRIER

- A. Specified by Subcontractor with approval of Contractor's Engineer. May include the use of wood chip berms.

2.017 SEEDING

- A. See Section 32 92 19, Topsoil and Seeding, for permanent grass vegetation.

2.018 SILT FENCE

- A. Geotextile: As specified in paragraph 2.09.
- B. Reinforcing: Welded wire fabric, 14-gauge minimum with 2-inch by 4-inch mesh.
- C. Support Posts: As recommended by manufacturer of geotextile.
- D. Fasteners: Heavy-duty wire staples at least 1-inch long, tie wires, or hog rings, as recommended by manufacturer of geotextile.

2.019 STAFF GAUGE

- A. Detail is shown on construction drawings. Submit product data from staff gauge manufacturer and sign manufacturer for approval prior to ordering. Submit product data on fasteners, clamps, and other attachment hardware.

2.020 TEMPORARY PIPE SLOPE DRAIN

- A. Corrugated polyethylene drain pipe, couplings and fittings (up to 10-inch) meeting the requirements of AASHTO M 252 Type C (corrugated both inside and outside) or Type S (corrugated outer wall and smooth inner liner). Maximum pipe size for temporary pipe slope drain shall be 10 inches diameter.

2.021 TURF REINFORCING MAT

- A. A rolled erosion control product composed of non-degradable synthetic fibers, filaments, nets, wire mesh and/or other elements, processed into a permanent, three-dimensional matrix of sufficient thickness. Turf Reinforcing Mats shall be supplemented with degradable components, are designed to impart immediate erosion protection, enhance vegetation establishment and provide long-term functionality by permanently reinforcing vegetation during and after maturation.
- B. Subcontractor shall submit product data, installation and anchoring instructions, and drainage flow computations for turf reinforcing mat where proposed for use.

2.022 WATTLES

- A. Cylinders of biodegradable plant material such as weed-free straw, coir, compost, wood chips, excelsior, or wood fiber or shavings encased within biodegradable netting. Typical diameter = 5 inches minimum.
- B. Netting Material: Clean, evenly woven, and free of encrusted concrete or other contaminating materials such as preservatives. Also free from cuts, tears, or weak places with a minimum lifespan of 6 months.
- C. Compost Filler: Coarse compost, wood chips, or wood shavings.
- D. Wood Stakes: Untreated softwood species, 2-inch by 2-inch nominal dimension and 36 inches in length.

2.023 WHEEL WASH FACILITY

- A. Detail as shown on construction drawings. Specified by Subcontractor with approval of Contractor's Engineer. Subcontractor may also propose use of pressure washing that will drain to a 10-ft by 10-ft drainage sump.
- B. Wheel wash facility to have non-erosive base. A 10-ft wide water depression will have 12 inches grade change to allow sediment to flow to the low side of the depression, to help prevent re-suspension of sediment. Install drainpipe with riser (2-ft to 3-ft diameter) at the low side of the water depression to allow for cleaning and refilling. The water depression shall typically hold 15 inches of water after displacement.

2.024 WOOD CHIPS

- A. Wood Chips: Derived from onsite wood-chipping activity on trees felled during site clearing work. Use wood chips for sediment barrier berms, or for use as a thin mulch blanket. Excess wood chips may be stockpiled at locations as directed by Subcontract Technical Representative (STR).

PART 3: EXECUTION

3.01 PREPARATION

A. Site Preparation:

1. The site shall be prepared in accordance with Best Management Practices (BMPs) for the installation of engineering filter fabrics and other surface control features. Site preparation and field installation for BMPs shall be as directed in these specifications, TDEC Erosion and Sediment Control Handbook, and Stormwater Management Requirements for OSWDF Groundwater Field Demonstration.
2. The surface location of each erosion and sediment control measure shall be loosely compacted, and pockets of soft soil removed and replaced as necessary, to provide a consistently uniform and stable surface for installation.

3.02 INSTALLATION/APPLICATION

A. General:

1. Control surface water runoff onsite and provide temporary soil stabilization measures as required to prevent the removal of soil by the action of either water or wind, more commonly known as erosion. Protect land areas adjacent to the work site from sedimentation by the installation of erosion and sediment control measures. Install, as a first step in the construction operation, perimeter barriers, and other measures intended to deter erosion and the transport of sediment associated with construction activities. Make sure measures are functional before upslope land disturbance takes place.
2. Seed and mulch completed slopes, ditches, and other areas within 15 days of completion.

B. Silt Fences:

1. Install silt fence as indicated on the construction drawings and at natural drainage areas as to reduce the quantity of sediment and flow velocities to downstream areas.
2. Install the preassembled silt fence in accordance with the manufacturer specifications.

C. Erosion Control Matting:

1. Erosion control matting shall be installed on slopes steeper than 4:1 and all ditches not lined with riprap.

2. Place the matting 2 to 3 feet over the top of the slope and into an excavated end trench that measures approximately 12-inches deep by 6-inches wide. Then pin the matting at 1-foot intervals along the bottom of the trench. Place backfill into the trench, and compact backfill.
3. Unroll the erosion control matting down the slope, maintaining direct contact between the soil and the matting. Overlap adjacent rolls a minimum of 3 inches.
4. Pin the erosion control matting to the ground using staples or pins in a typical 3-foot center-to-center pattern or as recommended by manufacturer.
5. Drive the anchoring devices (biodegradable staples or wooden stakes) so that the top of the staple is flush with the ground, or top of the stake is 4 inches above the ground surface. Anchor each erosion control mat every 3 feet along its center.
6. Longitudinal overlaps must be sufficient to accommodate a row of anchors and uniform along the entire length of overlap and anchored every 3 feet along the overlap length. Roll ends may be spliced by overlapping 2 feet (in the direction of water flow), with the upstream/upslope mat placed on top of the downstream/downslope mat and anchored at 1-foot spacing across the erosion control mats.
7. When installing multiple mats heat-seamed in the factory, all factory seams and field overlaps shall be similarly anchored.
8. Install per TDEC Erosion and Sediment Control Handbook standards and manufacturer instructions.

D. Straw Wattles:

1. Wattles shall be installed in a shallow trench forming a continuous barrier along the contour (across the slope) to intercept water running down a slope.
2. Joints within a ditch section should be avoided. However, where joints are necessary, a second row of tubes or wattles is required with the joints staggered by a distance equal to half of the individual segment length.
3. Remove all rocks, clods, vegetation or other obstructions so installed tubes and wattles have direct contact with the underlying soil surface.
4. Install tubes and wattles by laying them flat on the ground. Install stakes at spacings per the manufacturer's recommendation. Stakes should be installed on the downstream side of the wattles/tubes.
5. Install so no gaps exist between the soil and the bottom of the tube.
6. Install per TDEC Erosion and Sediment Control Handbook standards.

E. Sediment Basin with Porous Baffles:

1. Clear, grub, and strip the area only underneath the main embankment through which the sediment basin outlet pipe passes. Remove soil and stockpile/dispose. Place embankment fill in lifts not to exceed 9 inches and machine-compact. Overfill the embankment by 6 inches to allow for settlement.
2. Construct the precast concrete detention outlet structure (specified in Section 33 40 00) at corner of sediment basin, per construction drawing details. Install safety grate (specified in Section 33 40 00) as shown on construction drawings or per manufacturer instructions.
3. Install the outlet pipe barrel and associated anti-seep collars (specified in Section 33 40 00). Connections between the anti-seep collars and the pipe barrel shall be watertight. Achieve 95% soil compaction around the anti-seep collars. Do not place anti-seep collars within 2 feet of a pipe joint.
4. Clear, grub, and strip the areas to construct the remaining embankments for the sediment basin. Compact the remaining embankments in the same fashion as the main embankment. Construct the emergency spillway. Stabilize the embankments and all sloped areas, prior to excavating the remainder of the sediment basin area.
5. Clear, grub, and strip the remaining area of the sediment basin. Grade the sediment basin storage zones, and compact the subgrades and all prepared slopes.
6. Install filter ring at the sediment basin inlet, per the construction drawings.
7. Install porous baffles equally spaced as shown on construction drawings. Place steel posts at 2-ft depth and maximum 4-ft spacing. Dig trench on uphill side of steel posts to bury porous fabric material into trench and attach to steel posts. Install a support rope or wire across top of porous baffle assembly. Securely fasten porous fabric material to steel posts and industrial netting using 9-gauge wire ties or fasteners.
8. Install gabion baskets near sediment basin outlet (precast detention structure) per construction drawings. Place gabion riprap infill, and supplement with clean aggregate stone to help fill riprap voids in interior of gabion baskets,
9. Install the basin dewatering system (Faircloth floating skimmer, specified in Section 33 40 00), per the construction drawings and the manufacturer's installation instructions.
10. Install staff gauge at location shown on the construction drawings.
11. Install and maintain sediment basin in accordance with the TDEC Erosion and Sediment Control Handbook standards.

F. Filter Ring:

1. The filter ring shall be constructed of TDOT Class A-1 (clean from fines) riprap as specified in Section 31 37 00, Riprap.
2. A woven geotextile shall be used as a separator between the graded stone and soil base. Geotextile fabric shall be trenched into the subgrade soils. The geotextile fabric shall be placed immediately adjacent to the subgrade without any voids and extend to beneath the inlet to prevent scour within the filter ring.
3. The filter ring shall be constructed at a height of two feet with slopes no steeper than 2:1. Install per TDEC Erosion and Sediment Control Handbook standards.

G. Gabion Baskets:

1. Excavate to specified depth for gabion baskets, and compact subgrade. Cut and place woven geotextile on subgrade.
2. Assemble gabion baskets and place into position prior to backfilling with riprap infill. Check that internal bracing and diagonal reinforcements are in place and undamaged. Per the manufacturer installation instructions, attach the gabion baskets to each other horizontally prior to backfilling.
3. For gabion basket infill, initially place riprap by hand into the corners of each gabion compartment. Gently place additional riprap to fill each gabion compartment per manufacturer installation instructions.

H. Hydroseed or Hydromulch:

1. Do not apply any type of hydraulic seeding or mulching during high wind conditions or very dry conditions.
2. Prohibit foot, equipment and vehicle traffic across the area after application.
3. Apply uniformly, providing a minimum of 95% coverage of all hydromulched surfaces based upon visual inspection. To aid in visually verifying the correct application, a green dye shall be added to the mixture.
4. To ensure the proper application rate, mark off a section on the ground, such as a 1,000 square feet area, and calibrate the sprayer to apply the correct seeding rate for 1,000 square feet.
5. Hand seeding and application of straw mulch may be used at locations that are inaccessible to hydraulic application equipment.
6. Install per TDEC Erosion and Sediment Control Handbook standards and per Specification 32 92 19.

I. Turf Reinforcing Mats (TRM):

1. Grade and compact the area on the slope where TRM will be installed. The slope surface should be uniform and smooth, having all rocks, clods, vegetation or other objects removed so that during TRM laydown, it comes in direct, intimate contact with the slope surface.
2. Prepare the area to be armored with TRM by loosening the topsoil to promote better vegetation establishment. This may be accomplished with a rotary tiller on slopes 3:1 or flatter. For slopes greater than 3:1, prepare topsoil in a safe manner. Also incorporate site preparations that are included in Specification 32 92 19.
3. Excavate a Crest of Slope (COS) trench 12 in x 12 in minimum at a distance of 3 ft from the crest of the slope.
4. Excavate a Toe of Slope (TOS) trench 12 in x 12 in minimum at a minimum distance of 5 ft from the toe of the slope.
5. Install and handle TRM in accordance with manufacturer instructions. Place backfill material into COS and TOS anchor trenches, and provide compaction per manufacturer instructions.

J. Rock Check Dams and Filter Socks:

1. Prior to installing rock check dams or filter socks, construct the roadside ditch with TRM lining per manufacturer instructions.
2. Install temporary rock check dam as shown on construction drawings at regular spacing. Install at least one temporary filter sock between each rock check dam as an additional measure to slow ditch velocities. Adjust rock check dam spacing and filter sock spacing to handle field conditions or as directed by the Subcontract Technical Representative (STR).

3.03 TEMPORARY SEEDING

A. Temporary Seeding Mixes and Application:

1. Temporary seeding for late winter and early spring -

Species	Rate (lb/acre)
Rye	120
Seeding dates	
East	Above 2500 feet: Feb. 15 - May 15 Below 2500 feet: Feb. 1 - May 1
Middle	Jan. 1 - May 1
West	Dec. 1 - Apr. 15
Soil amendments	
Follow recommendations of soil tests or apply 2,000 lb/acre ground agricultural limestone and 750 lb/acre 10-10-10 fertilizer.	
Mulch	
Apply 4,000 lb/acre straw. Anchor straw by tacking with asphalt, netting, or a mulch anchoring tool. A disk with blades set nearly straight can be used as a mulch anchoring tool.	
Maintenance	
Refertilize if growth is not fully adequate. Reseed, refertilize and mulch immediately following erosion or other damage.	

2. Temporary seeding for summer -

Species	Rate (lb/acre)
Oats	60
Brown top millet	30
Seeding dates	
East	May 15 - Aug. 15
Middle	May 1 - Aug. 15
West	Apr. 15 - Aug. 15
Soil amendments	
Follow recommendations of soil tests or apply 2,000 lb/acre ground agricultural limestone and 750 lb/acre 10-10-10 fertilizer.	
Mulch	
Apply 4,000 lb/acre straw. Anchor straw by tacking with asphalt, netting, or a mulch anchoring tool. A disk with blades set nearly straight can be used as a mulch anchoring tool.	
Maintenance	
Refertilize if growth is not fully adequate. Reseed, refertilize and mulch immediately following erosion or other damage.	

3. Temporary seeding for fall -

Species	Rate (lb/acre)
Oats	30
Winter wheat	30

Seeding dates

East	Aug 15 – Dec 15
Middle	Aug. 15 – Dec 30
West	Aug. 15 – Dec 30

Soil amendments
Follow recommendations of soil tests or apply 2,000 lb/acre ground agricultural limestone and 750 lb/acre 10-10-10 fertilizer.

Mulch
Apply 4,000 lb/acre straw. Anchor straw by tacking with asphalt, netting, or a mulch anchoring tool. A disk with blades set nearly straight can be used as a mulch anchoring tool.

Maintenance
Refertilize if growth is not fully adequate. Reseed, refertilize and mulch immediately following erosion or other damage. If necessary to extend temporary cover beyond June 15, overseed with 50 lb/ac crimson clover in late February or early March.

B. Preparation for Temporary Seeding:

1. Complete grading before preparing seeded area and install all necessary erosion control measures. Minimize steep slopes which make seedbed preparation difficult and increases the erosion hazard. If soils become compacted during grading, loosen them to a depth of 6 to 8 inches using a ripper, harrow, or chisel plow.
2. Excessive water runoff shall be reduced by properly designed and installed erosion control practices such as ditches, dikes, diversions, and sediment ponds.
3. Prepare a good seedbed that is well pulverized, loose and uniform. Where hydroseeding methods are used, the surface may be left with a more irregular surface of large clods and stones.
4. Reseed and mulch areas where seedling emergence is poor or where erosion occurs, as soon as possible. Do not mow.

END OF SECTION

**SPECIFICATION
 FOR
 SECTION 31 11 00
 SITE CLEARING AND GRUBBING
 GROUNDWATER FIELD DEMONSTRATION (GWFD)**

		JOB NO.	
		SPECIFICATION NO.	SPC-OSWDF-I299
		SHEET	1 of 7
	Name	Signature	Date
Originator	Ken Oliver, PE		6/06/2023
Checker	David Matlock, PE		6/06/2023
Additional Reviewer	Butch Parton, PE		6/06/2023
Additional Reviewer			
Project Engineer	Greg Pickerel, PE		

Revision History		
Rev. No.	Reason For Revision	Date
0	Issued For Construction	6/06/2023



Form-362 (02/23) Rev. 3
 PROC-DE-1007

SECTION 31 11 00
SITE CLEARING AND GRUBBING

PART 1: GENERAL

1.01 DESCRIPTION

- A. This section addresses the clearing and grubbing of trees, brush, and other vegetation from the project site. Clearing limits are shown on construction drawings.
- B. The project site has merchantable timber that will have been previously harvested by others. The project site will have tree stumps, root balls, tree trunks and limbs, and slash piles that remain from the timber harvesting operations. Subcontractor will finish the clearing activities, perform grubbing operations, and generally turn usable woody debris into wood chips for use on site.

1.02 DEFINITIONS

- A. Interfering or Objectionable Material: Trash, rubbish, and junk; vegetation and other organic matter, whether alive, dead, or decaying; and topsoil.
- B. Clearing: Removal of interfering or objectionable material lying on or protruding above ground surface.
- C. Grubbing: Removal of vegetation and other organic matter including stumps, buried logs, and roots greater than 2 inch caliper to a depth of 6 inches below subgrade.
- D. Stripping: Removal of top 4 feet of soil profile measured from existing ground surface after applicable clearing and grubbing is completed.
- E. Clearing Limits: Areas, as shown or specified, within which Work is to be performed.
- F. Unsuitable Material: As defined under Section 31 23 16, Excavation.

1.03 REFERENCES

- A. International Fire Code, Section 2808 (2018), International Code Council.

1.04 SUBMITTALS

- A. The following documents shall be submitted to the Subcontract Technical Representative (STR) in accordance with the requirements of Exhibit I of the Subcontract.

- B. Clearing and Grubbing Plan (prior to implementation) that includes: Procedures to be used, protection methods for nearby existing wetlands and vegetation, descriptive list of equipment that includes wood chipping and stump grinding, and approximate work extent for each phase of site clearing.

1.05 SCHEDULING AND SEQUENCE

- A. Perform site clearing work only after adequate erosion and sediment controls are in place. Limit the bare earth areas that are exposed to uncontrolled erosion to manageable sizes. Install adequate erosion and sediment control measures for each area of bare earth.
- B. The Subcontractor shall keep detailed records of all activities, correspondence, and related documents until the Subcontract Technical Representative (STR) has accepted the clearing and grubbing as required by the contract and construction drawings.

PART 2: PRODUCTS

2.01 MATERIALS

- A. The Subcontractor shall furnish all materials, tools, equipment, facilities, and services as required for performing site clearing, grubbing and other site preparation work.

PART 3: EXECUTION

3.01 PROTECTION OF EXISTING PIEZOMETERS TO REMAIN

- A. Protect existing piezometers that are indicated to remain (as shown on drawings) from any damage incidental to the clearing, grubbing, and construction operations. Suspend work and notify the Subcontract Technical Representative (STR) immediately of damage to an existing piezometer.

3.02 PROTECTION OF TREES AND SHRUBS OUTSIDE OF LIMITS

- A. Protect nearby trees and vegetation to remain from any damage incidental to the clearing, grubbing, and construction operations.

3.03 PROTECTION OF UTILITY LINES

- A. Protect from damage existing utility lines that are indicated to remain. Suspend work and notify the Subcontract Technical Representative (STR) immediately of damage to an existing utility line. The Subcontractor is responsible for the repairs of any damage to existing utility lines that are indicated or made known to the Contractor prior to start of clearing and grubbing operations.

3.04 WORK LIMITS FOR CLEARING, GRUBBING, AND STRIPPING

- A. Site clearing limits:
 - 1. Excavation: 5 feet beyond top of cut slopes.
 - 2. Fill:
 - a. Clearing and Grubbing: 8 feet beyond toe of embankment fill.
 - b. Stripping: 5 feet beyond toe of embankment fill.
 - 3. Roadways: 5 feet from roadway shoulders.
 - 4. Overhead Utilities:
 - a. Clearing and Grubbing: Entire width of easements and rights-of-way.
 - b. Stripping: Wherever grading is required.
 - 5. Other Areas: 5 feet from new work.
- B. Remove rubbish, trash, and junk from entire area within the project limits.

3.05 CLEARING

- A. Merchantable timber will be previously harvested by others. Removal of remaining stumps and slash piles will be the responsibility of the Subcontractor.
- B. Clearing shall consist of the felling, trimming, and cutting of trees into sections and the satisfactory disposal of the trees and other vegetation designated for removal, including downed timber, snags, brush, and rubbish occurring within the areas to be cleared. Trees, stumps, roots, brush, and other vegetation in areas to be cleared shall be cut off flush with or below the original ground surface.
- C. Clear areas within limits shown or specified. Fell trees in a direction so that nearby facilities and vegetation-to-remain are not damaged.
- D. For trees that are outside the clearing limits by 10 feet or less, cut off stumps flush with ground surface but grubbing is not necessary. The 10-ft limit may require adjustment at locations where the clearing limits approach environmentally sensitive natural resources, or if felling of a large mature tree near the clearing limit needs to be assessed by the Subcontract Technical Representative (STR). In these cases, more precise removal of trees near the clearing limit may be necessary to minimize impacts to natural resources.
- E. Cut off shrubs, brush, weeds, and grasses to within 2 inches of ground surface.

3.06 GRUBBING

- A. Grubbing shall consist of the removal and disposal of stumps, roots greater than 2 inch caliper to a depth of 6 inches below subgrade, and matted roots from the designated grubbing areas. Remove grubbed material to a depth of not less than 18 inches below the original surface level of the ground in areas indicated to be grubbed and in areas indicated for project construction under this subcontract. Fill depressions with suitable material and compact to make the surface conform with the original adjacent ground surface.
- B. Do not start earthwork operations in areas where clearing and grubbing are not complete, except that stumps and large roots may be removed concurrently with excavation when allowed by the Contractor. The Subcontractor shall immediately segregate stumps and large roots to a separate pile from excavated material.
- C. Topsoil shall only be stripped from areas that will be disturbed by excavation, filling, paving, or compaction by equipment. Topsoil shall be stripped and stockpiled onsite before grading activities are commenced in any new area of the site. Contractor will designate locations suitable for temporary storage of soil. The stockpiled topsoil shall be stabilized using BMPs in accordance with Section 31 25 00.

3.07 DISPOSAL OF MATERIALS

- A. Chipping: Trees, brush, logs, stumps, roots, rotten wood, and other refuse from the clearing and grubbing operations, shall be chipped onsite and placed into stockpiles at locations designated by the Subcontract Technical Representative (STR). The stockpiles containing wood chips shall be stabilized and protected similar to topsoil stockpiles and as directed by the STR.
- B. Wood Chip Piles: Woody debris may be chipped onsite to provide a supply of wood chips for use in enhancement of sediment and erosion controls. Wood chip pile sizes and spacing shall be in accordance with the 2018 International Fire Code, Section 2808, which is attached as page 7 of this specification section.
- C. Disposal:
 - 1. Remove and dispose of excess or poor-quality wood chips as directed by the Subcontract Technical Representative (STR).
 - 2. When directed by STR, wood chips may be used for project site erosion and sediment control. Place wood chips in a nominal 4-inch layer in lieu of seeding or straw mulch, in locations that will not block drainage patterns or affect existing tree roots.
 - 3. Burying of trash and debris at the site will not be permitted. Burning of trash and debris at the site will not be permitted.

4. Remove trash and debris from the site at frequent intervals so that its presence will not delay the progress of the work, cause hazardous conditions for workers or the traveling public, or become unsightly.
5. Excess/unwanted materials, waste, trash, and debris shall be removed from the project site by the Subcontractor. Subcontractor shall dispose of waste, trash, and debris at the ORR Construction/Demolition Landfill VII or Industrial Landfill V or as directed by the STR. Waste disposed at the ORR Construction/Demolition Landfill VII or at Industrial Landfill V must meet Contractor's acceptance criteria and must have advance approval from the Contractor's Waste Certification Representative.

D. Stripped Soils

1. Dispose of stripped soils that are unsuitable for topsoil or that exceed quantity required for topsoil where directed onsite by STR.
2. Stockpile topsoil in sufficient quantity to meet the project needs, at onsite locations determined by STR.

3.08 ATTACHMENT

A. The attachment listed below, following "End of Section," is a part of this specification.

1. Section 2808. Storage and Processing of Wood Chips, Hogged Materials, Fines, Compost, Solid Biomass Feedstock and Raw Products Associated With Yard Waste, Agro-Industrial, Recycling Facilities.
International Fire Code (2018), page 28-3, International Code Council.

END OF SECTION

SECTION 2808
STORAGE AND PROCESSING OF WOOD CHIPS,
HOGGED MATERIALS, FINES, COMPOST, SOLID
BIOMASS FEEDSTOCK AND RAW PRODUCT
ASSOCIATED WITH YARD WASTE, AGRO-
INDUSTRIAL AND RECYCLING FACILITIES

2808.1 General. The storage and processing of wood chips, hogged materials, fines, compost, solid biomass feedstock and raw product produced from yard waste, debris and agro-industrial and recycling facilities shall comply with Sections 2808.2 through 2808.10.

2808.2 Storage site. Storage sites shall be level and on solid ground, elevated soil lifts or other all-weather surface. Sites shall be thoroughly cleaned before transferring wood products to the site.

2808.3 Size of piles. Piles shall not exceed 25 feet (7620 mm) in height, 150 feet (45 720 mm) in width and 250 feet (76 200 mm) in length. Stackable products shall not be stacked in excess of 25 feet (7620 mm) in height, 80 feet (24 384 mm) in width and 250 feet (76 200 mm) in length.

2808.3.1 Increase in pile or stack size. Piles or stackable products are permitted to be increased beyond the dimensions in Section 2808.3 provided that a written fire protection plan is *approved* by the *fire code official*. The fire protection plan shall include, but not be limited to, the following:

1. Contact information for after-hours response by facility personnel.
2. Storage yard areas and material-handling equipment selection, pile design and arrangement shall be based on sound safety and fire protection principles.
3. Fire apparatus access roads around the piles or stacks and access roads to the top of piles, if applicable, shall be established, identified and maintained.
4. The potential for spontaneous heating shall be evaluated and provisions made to control the temperature of the piles. Methods for monitoring the internal temperature of the pile shall be provided.
5. Routine yard inspections shall be conducted by trained personnel.
6. A means for early fire detection and reporting to the public fire department shall be provided.
7. Facilities and equipment needed by the fire department for fire extinguishment shall be provided, including a water supply in compliance with Section 507 and heavy equipment necessary to move material.
8. A de-inventory plan shall be utilized to remove alternating piles or stacked products in a manner to increase the separation distances between the remaining piles or stacks.

9. The increased pile size shall be based on the capabilities of the installed fire protection systems and features.
10. A controlled burn area shall be provided on-site for smoldering or damaged product.

2808.4 Pile separation. Piles or stacked product shall be separated from buildings, property lines and adjacent piles or stacks by a distance of not less than one and one-half times the height of the pile or stack. The distance between rows shall be a minimum of 30 feet (9144 mm). *Approved* fire apparatus access roads shall be provided within the separation space in accordance with Section 503.

2808.5 Combustible waste. The storage, accumulation and handling of combustible materials and control of vegetation shall comply with Chapter 3.

2808.6 Static pile protection. Static piles shall be monitored by an *approved* means to measure temperatures within the static piles. Internal pile temperatures shall be monitored and recorded weekly. Such records shall be maintained. An operational plan indicating procedures and schedules for the inspection, monitoring and restricting of excessive internal temperatures in static piles shall be submitted to the *fire code official* for review and approval.

2808.7 Pile fire protection. Automatic sprinkler protection shall be provided in conveyor tunnels and combustible enclosures that pass under a pile. Combustible conveyor systems and enclosed conveyor systems shall be equipped with an *approved automatic sprinkler system*.

2808.8 Fire extinguishers. Portable fire extinguishers complying with Section 906 and with a minimum rating of 4-A:60-B:C shall be provided on all vehicles and equipment operating on piles and at all processing equipment.

2808.9 Material-handling equipment. *Approved* material-handling equipment shall be available for moving wood chips, hogged material, wood fines and raw product during fire-fighting operations.

2808.10 Emergency plan. The *owner* or operator shall develop a plan for monitoring, controlling and extinguishing spot fires and submit the plan to the *fire code official* for review and approval.

SECTION 2809
EXTERIOR STORAGE OF FINISHED LUMBER
AND SOLID BIOFUEL PRODUCTS

2809.1 General. Exterior storage of finished lumber and solid biofuel products shall comply with Sections 2809.2 through 2809.5.

2809.2 Size of piles. Exterior storage shall be arranged to form stable piles with a maximum height of 20 feet (6096 mm). Piles shall not exceed 150,000 cubic feet (4248 m³) in volume.

2809.3 Fire apparatus access roads. Fire apparatus access roads in accordance with Section 503 shall be located so that a maximum grid system unit of 50 feet by 150 feet (15 240 mm by 45 720 mm) is established.

Excerpt is taken from:
 2018 International Fire Code, Section 2808,
 Page 28-3
 International Code Council

**SPECIFICATION
 FOR
 SECTION 31 23 13
 SUBGRADE PREPARATION
 GROUNDWATER FIELD DEMONSTRATION (GWFD)**

		JOB NO.	
		SPECIFICATION NO.	SPC-OSWDF-I300
		SHEET	1 of 5
	Name	Signature	Date
Originator	Ken Oliver, PE		6/06/2023
Checker	David Matlock, PE		6/06/2023
Additional Reviewer	Butch Parton, PE		6/06/2023
Additional Reviewer			
Project Engineer	Greg Pickerel, PE		

Revision History		
Rev. No.	Reason For Revision	Date
0	Issued For Construction	6/06/2023



Form-362 (02/23) Rev. 3
 PROC-DE-1007

SECTION 31 23 13
SUBGRADE PREPARATION

PART 1: GENERAL

1.01 DESCRIPTION

- A. This section covers the requirements for subgrade preparation.

1.02 DEFINITIONS

- A. Optimum Moisture Content: As defined in Section 31 23 23, Fill Material and Placement.
- B. Overexcavation of Unsuitable Materials: Materials identified by the Contractor's Engineer during proof-rolling or compaction efforts that require removal and replacement.
- C. Prepared Subgrade: Ground surface after completion of clearing and grubbing, stripping of topsoil, excavation to grade, and scarification and compaction of subgrade.
- D. Proof-roll: Testing subgrade and fill material to identify soft areas by driving over an area with a loaded 34 cubic yard scraper > 80 tons gross weight, loaded tandem axle dump truck > 30 tons gross weight, or loaded articulated dump truck > 50 tons gross weight.
- E. Relative Compaction: As defined in Section 31 23 23, Fill Material and Placement.
- F. Subgrade for Embankment Fill and Select Earth Fill: Layer of prepared subgrade after completion of clearing, grubbing, excavation of unsuitable material prior to placement of embankment fill, select earth fill, or mineral aggregate base.
- G. Subgrade for Cover System: Prepared subgrade for placement of cover system.
- H. Undercutting: Excavation of soft areas of soil in the subgrade or fill. Soft areas identified by proof-rolling shall be undercut and replaced with rock fill or satisfactory material (as directed by the Geotechnical Engineer or Technician) placed and compacted with heavy equipment until the area has been stabilized.

1.03 REFERENCES

- A. ASTM International (ASTM):
 - 1. ASTM D698, Standard Test Methods for Laboratory Compaction Characteristics of Soil Using Standard Effort (12,400ft-lbf/ft³)

2. ASTM D6938, Standard Test Methods for In-Place Density and Water Content of Soil and Soil-Aggregate by Nuclear Methods (Shallow Depth)

1.04 SUBMITTALS

- A. The following documents shall be submitted to the Subcontract Technical Representative (STR) in accordance with the requirements of Exhibit I of the Subcontract.
 1. Test and Inspection Reports:
 - a. Tests for moisture-density relation.
 - b. Density and moisture tests.
 - c. Inspection reports of proof-rolling (and undercutting and backfill if required).
 - d. Certification that backfill for undercut meets the specification.
 - e. Weekly letter reports by Geotechnical Engineer/Technician.

1.05 QUALITY CONTROL INSPECTION AND TESTING

- A. The Subcontractor shall retain a licensed Testing Laboratory, Geotechnical Engineer, and Geotechnical Field Technician with qualifications and duties as listed in Specification 31 23 23, approved by the Subcontract Technical Representative (STR) to perform inspections and testing.
- B. The Geotechnical Engineer/Technician shall be onsite to perform inspections of excavations, fill placement, and compaction testing throughout construction. The Geotechnical Engineer/Technician shall provide weekly letter reports of inspections and reports of all test results at the beginning of the following week.

1.06 SCHEDULING AND SEQUENCING

- A. Complete applicable work specified in Section 31 11 00, Site Clearing and Grubbing, and Section 31 23 16, Excavation, prior to beginning subgrade preparation.
- B. Prepare subgrade when unfrozen and free of ice and snow.
- C. Notify Subcontract Technical Representative (STR) when subgrade is ready for compaction or proof-rolling or whenever compaction or proof-rolling is resumed after a period of extended inactivity.

PART 2: PRODUCTS

2.01 MATERIALS

- A. The Subcontractor shall furnish all materials, tools, and equipment as required for performing subgrade preparation.

PART 3: EXECUTION

3.01 GENERAL

- A. Keep subgrade free of water, debris, and foreign matter during compaction or proof-rolling.
- B. Bring subgrade to proper lines, grades and cross-sections, and then uniformly compact surface.
- C. Do not use sections of prepared ground surface as haul roads. Protect prepared subgrade from traffic.
- D. Maintain prepared ground surface in finished condition until next course is placed.

3.02 SUBGRADE FOR EMBANKMENT FILL AND SELECT EARTH FILL

- A. Under Embankment Fill: Compact subgrade using minimum of three passes with a vibratory sheepsfoot roller weighing a minimum of 10 tons to create a firm unyielding surface. Other compaction equipment, including heavy non-vibratory rollers, may be used for subgrade compaction under embankments, when approved by Contractor's Engineer.
- B. Under Access Road: Scarify and compact the upper 6 inches to minimum of 95 percent relative compaction as determined in accordance with ASTM D698.

3.03 SUBGRADE FOR COVER SYSTEM

- A. After completion of embankment fill or excavation to grades as shown on construction drawings, prepare the subgrade surface for the geomembrane lining system by scarifying and compacting the top 6 inches of excavation to 95 percent relative compaction as determined in accordance with ASTM D698. Moisture condition as necessary to achieve specified compaction. Leave subgrade smooth and without ruts.

3.04 SUBGRADE FOR DITCHES AND POND BOTTOMS

- A. Subgrade shall meet requirements of embankment fill.

- B. In areas where ditches will be lined, subgrade shall be rolled smooth for geomembrane liner placement.

3.05 MOISTURE CONDITIONING

- A. Dry Subgrade: Scarify the surface, add water, then mix to make moisture content uniform throughout.
- B. Wet Subgrade: Aerate material by blading, disking, harrowing, or other methods, to hasten drying process.

3.06 TESTING

- A. Under Embankment Fill and Pond Bottom: Perform proof-roll using loaded dump truck or similar heavy-wheeled vehicle to detect soft or loose subgrade or unsuitable material, as determined by Contractor's Engineer.
- B. Under Access Road or Geomembrane Liner: Subcontractor shall provide an independent testing laboratory to conduct in-place density tests in accordance with ASTM D6938 at a minimum rate of one test per every 200 linear feet of prepared subgrade along the access road alignment.

3.07 CORRECTION

- A. Soft or Loose Subgrade:
 - 1. Adjust moisture content and recompact, or
 - 2. Overexcavate as specified in Section 31 23 16, Excavation, and replace with embankment fill or structural fill from the excavation, as specified in Section 31 23 23, Fill Material and Placement.
- B. Overexcavation of Unsuitable Material: Overexcavate as specified within Section 31 23 16, Excavation, and replace with embankment fill or structural fill from the excavation, as specified in Section 31 23 23, Fill Material and Placement.

END OF SECTION

**SPECIFICATION
 FOR
 SECTION 31 23 23
 FILL MATERIAL AND PLACEMENT
 GROUNDWATER FIELD DEMONSTRATION (GWFD)**

		JOB NO.	
		SPECIFICATION NO.	SPC-OSWDF-I302
		SHEET	1 of 15
	Name	Signature	Date
Originator	Ken Oliver, PE		6/06/2023
Checker	David Matlock, PE		6/06/2023
Additional Reviewer	Butch Parton, PE		6/06/2023
Additional Reviewer			
Project Engineer	Greg Pickerel, PE		

Revision History		
Rev. No.	Reason For Revision	Date
0	Issued For Construction	6/06/2023



Form-362 (02/23) Rev. 3
 PROC-DE-1007

SECTION 31 23 23
FILL MATERIAL AND PLACEMENT

PART 1: GENERAL

1.01 DESCRIPTION

- A. This section covers the requirements for soils fill material, placement, and compaction.

1.02 DEFINITIONS

- A. Geosynthetics: Geotextiles, geogrids, geomembranes, artificial turf, or a composite of these materials.
- B. Lift: Loose (uncompacted) layer of material.
- C. Optimum Moisture Content:
 - 1. Determined in accordance with ASTM D698 to determine optimum moisture content.
 - 2. Determine field moisture content per the pertinent ASTM method.
- D. Prepared Subgrade: Ground surface after completion of required demolition, clearing and grubbing, stripping of topsoil, excavation to grade, and subgrade preparation.
- E. Relative Compaction:
 - 1. Ratio, in percent, of as-compacted field dry density to laboratory maximum dry density as determined in accordance with ASTM D698.
 - 2. Apply corrections for oversize material to either as-compacted field dry density or maximum dry density, as determined by Contractor's Engineer.
- F. Satisfactory Materials: Satisfactory materials include any materials classified by ASTM D2487 as GW, GP, GM, GC, SW, SP, SM, SC, ML, CL, or CH. Satisfactory materials for grading may include minor quantities of rock less than 3 inches in any dimension that will not affect soil compaction requirements.
- G. Unsatisfactory Materials: Materials which do not comply with the requirements for satisfactory materials are unsatisfactory. Unsatisfactory materials also include excessively wet soil, man-made fills, trash, refuse, backfills from previous construction, any material containing chemical contamination, and any material which contains root and other organic matter or frozen material. Notify the Subcontract Technical Representative (STR) when encountering any unsatisfactory materials.

1.03 REFERENCES

A. American Association of State Highway Transportation Officials (AASHTO):

1. AASHTO R 18, Standard Practice for Establishing and Implementing a Quality Management System for Construction Materials Testing Laboratories

B. ASTM International (ASTM):

1. ASTM C88, Standard Test Method for Soundness of Aggregates by Use of Sodium Sulfate or Magnesium Sulfate
2. ASTM C117, Standard Test Method for Materials Finer Than 75 micrometer (No. 200) Sieve in Mineral Aggregates by Washing
3. ASTM C125, Standard Terminology Relating to Concrete and Concrete Aggregates
4. ASTM C128, Standard Test Method for Relative Density (Specific Gravity) and Absorption of Fine Aggregate
5. ASTM C131, Standard Test Method for Resistance to Degradation of Small-Size Coarse Aggregate by Abrasion and Impact in the Los Angeles Machine
6. ASTM C136, Standard Test Method for Sieve Analysis of Fine and Coarse Aggregates
7. ASTM D75, Standard Practice for Sampling Aggregates
8. ASTM D448, Standard Specification for Sizes of Aggregate for Road and Bridge Construction
9. ASTM D698, Standard Test Methods for Laboratory Compaction Characteristics of Soil Using Standard Effort (12,400 ft-lbf/ft³)
10. ASTM D1140, Standard Test Methods for Determining the Amount of Material Finer than 75- μ m (No. 200) Sieve in Soils by Washing
11. ASTM D1556, Standard Test Method for Density and Unit Weight of Soil in Place by Sand-Cone Method
12. ASTM D2216, Standard Test Methods for Laboratory Determination of Water (Moisture) Content of Soil and Rock.
13. ASTM D2487, Standard Practice for Classification of Soils for Engineering Purposes (Unified Soil Classification System)

14. ASTM D2488, Standard Practice for Description and Identification of Soils (Visual-Manual Procedures)
 15. ASTM D2937, Standard Test Method for Density of Soil in Place by the Drive-Cylinder Method
 16. ASTM D3740, Standard Practice for Minimum Requirements for Agencies Engaged in Testing and/or Inspection of Soil and Rock as Used in Engineering Design and Construction
 17. ASTM D6938, Standard Test Methods for In-Place Density and Water Content of Soil and Soil-Aggregate by Nuclear Methods (Shallow Depth)
 18. ASTM E329, Standard Specification for Agencies Engaged in Construction Inspection, Testing, or Special Inspection
- C. Tennessee Department of Transportation (TDOT):
1. Standard Specifications for Road and Bridge Construction, Latest edition

1.04 SUBMITTALS

- A. The following documents shall be submitted to the Subcontract Technical Representative (STR) in accordance with the requirements of Exhibit I of the Subcontract.
1. Pre-Construction Submittals:
 - a. Qualifications and certifications for Testing Laboratory.
 - b. Qualifications, certifications and documentation experience for Geotechnical Engineer and Geotechnical Field Technician.
 - c. Documentation of current Nuclear Regulatory Commission radioactive material license, current calibration, and current leak test certification for each nuclear density gauge.
 - d. Sand Infill Placement Plan - to include materials, placement method, list of construction equipment, and protection of work.
 2. Test and Inspection Reports:
 - a. Soil classification tests for fill materials and Select Granular Materials.
 - b. Tests for moisture-density relation.
 - c. Density and moisture tests.
 - d. Inspection reports of proof-rolling (and undercutting and backfill if required).

- e. Weekly letter reports by Geotechnical Engineer/Technician.
 - f. Daily inspection reports for excavations requiring worker and/or equipment access per OSHA regulations.
 - g. Certification that backfill for undercut meets the specification.
3. Closeout Submittals:
- a. As-built topographic drawings.

1.05 QUALITY CONTROL INSPECTION AND TESTING

- A. The Subcontractor shall retain a licensed Testing Laboratory, Geotechnical Engineer, and Geotechnical Field Technician, qualified per the requirements of this specification and approved by STR to perform inspections and testing.
- B. Qualifications of Testing Laboratory: Shall be accredited per AASHTO R 18, ASTM D3740, and ASTM E329 and meeting the requirements for all testing standards and methods per this specification. The Testing Laboratory shall establish, maintain, and implement a program to identify, control, and calibrate test equipment.
- C. Qualifications of Geotechnical Engineer: Shall be a Tennessee-Registered Professional Engineer (PE) with active registration and appropriate experience to verify that work by the Subcontractor meets the specification requirements. The Geotechnical Engineer shall have a minimum of five years of experience in field oversight of civil earthworks and geotechnical engineering projects
- D. Qualifications of Geotechnical Field Technician: Shall be certified by the National Institute for Certification in Engineering Technologies (NICET) at Level II or III in Construction Materials Testing for Soils, or be able to demonstrate equivalency through an alternative certification program. Field technicians shall have a minimum of two years of experience performing field quality control for asphalt, concrete, and soil. Field technicians operating nuclear density gauges shall submit certification of training and records of participation in a dosimetry program.
- E. The Geotechnical Engineer and/or Geotechnical Field Technician shall be onsite to perform inspections of excavations, proof-rolling and fill placement, and compaction testing throughout construction. The Geotechnical Engineer and/or Geotechnical Field Technician shall provide weekly letter reports of inspections and reports of all test results at the beginning of the following week to the STR.
- F. The Geotechnical Engineer and/or Geotechnical Field Technician shall be the “Competent Person” required by OSHA regulations to perform daily inspections and assessments of excavations.

- G. The Subcontractor shall provide access to work areas and shall coordinate for inspections and testing by the Geotechnical Engineer/Technician. The Subcontractor shall provide the equipment and operator for proof-rolling.
- H. Access by Other Testing Firms: When requested by the STR, the Subcontractor shall provide immediate access to work areas for independent soil inspections or soil testing by other firms.

1.06 WEATHER LIMITATIONS

- A. Material excavated when frozen or when air temperature is less than 32 degrees F shall not be used as fill or backfill until material completely thaws.
- B. Material excavated during inclement weather shall not be used as fill or backfill until after material drains and dries sufficiently for proper compaction.

1.07 SEQUENCING AND SCHEDULING

- A. Complete the applicable work specified in Section 31 11 00, Site Clearing and Grubbing; Section 31 23 16, Excavation; and Section 31 23 13, Subgrade Preparation, prior to the placement of fill or backfill.
- B. Do not place embankment fill, select earth fill, structural fill, or mineral aggregate base until after subgrade has been prepared as specified in Section 31 23 13, Subgrade Preparation.

PART 2: PRODUCTS

2.01 MATERIALS

- A. The Subcontractor shall furnish all materials, tools, and equipment as required for performing excavation work.
- B. Fill material for compacted fill and trench backfill above the pipe section shall be natural fill material from offsite or shall be excavated onsite soil free of debris, foreign objects, large rock fragments, organics, and other deleterious materials. Visible rock particles shall be maximum dimension of 3 inches in any direction for 8-inch thick loose lifts. Smaller lifts shall have visible rock particles no larger than one-half of the lift thickness. Material for compacted fill shall conform to GC, SC, SM, ML, CL, or CH according to the Unified Soil Classification System per ASTM D2487.
- C. Select Granular Material: Select granular material shall consist of materials classified as GW or SW in accordance with ASTM D2487 where indicated. Not more than 10% by weight may be finer than No. 200 sieve when tested in accordance with ASTM D1140.

- D. Backfill for replacement of undercut soft soils shall be satisfactory material or shot rock or rubble stone riprap in accordance with TDOT Section 709.02.A.
- E. Construction water for moisture conditioning of the compacted fill shall be obtained from the onsite water source designated by the STR.
- F. Construction safety fence for activities shall be orange, high-density polyethylene, 4 feet in height, opening size approximately 4 inches by 1 inch, minimum tensile strength of 2,000 pounds per foot of width. Posts shall be T-shaped (T-post) or as approved by the STR.
- G. Topsoil: Soil containing organic material excavated onsite from the ground surface or near surface, or soil containing organic material obtained from an offsite source.

2.02 STRUCTURAL FILL

- A. Crushed gravel or crushed rock material consisting of excavated or imported granular material and free from dirt, clay balls, and organic matter. Limestone or shale bedrock may be used from required excavations provided it is crushed and sorted so as to be well graded from coarse to fine with 1-inch maximum size and 8 percent maximum passing the No. 200 sieve.

2.03 SELECT EARTH FILL

- A. Excavated lean clay, silt, and/or sand material from required excavations and designated borrow sites, free from rocks larger than 1 inch, from roots and other organic matter, ashes, cinders, trash, debris, and other deleterious materials.
- B. Liquid Limit less than 45 percent, Plasticity Index less than 25 percent.
- C. Gradation shall be as specified in accordance with ASTM C136.

<u>Sieve Size</u>	<u>Percent Passing by Weight</u>
1 inch	100
No. 4	85 – 90
No. 200	30 – 60

2.04 EMBANKMENT FILL

- A. Excavated lean clay, silt, sandy silt, and/or sandy lean clay material from required excavations or designated borrow areas, free from rocks larger than 3 inches, from roots and other organic matter, ashes, cinders, trash, debris, and other deleterious materials. Shall meet the following requirements:
 1. Liquid Limit less than 45 percent.
 2. Plasticity Index less than 25 percent.

2.05 SAND INFILL

- A. Fine aggregate angularity uncompact void content shall be greater than or equal to 40 percent in accordance with ASTM C125, Method A.
- B. Bulk oven-dry specific gravity shall be greater than or equal to 2.40 in accordance with ASTM C128.
- C. Gradation shall be as specified in accordance with ASTM C136.

<u>Sieve Size</u>	<u>Percent Passing by Weight</u>
3/8 inch	100
No. 4	90 – 100
No. 8	50 – 85
No. 16	25 – 65
No. 30	10 – 45
No. 50	0 – 30
No. 100	0 – 10
No. 200	0 – 5

2.06 GRANULAR DRAIN MATERIAL

- A. Round, competent, washed rock.
- B. Free from clay, organic matter, or other deleterious material.
- C. Gradation shall be as specified in accordance with ASTM C136.

<u>Sieve Size</u>	<u>Percent Passing by Weight</u>
1 1/2 inch	100
3/4 inch	80 – 100
3/8 inch	50 – 70
No. 4	20 – 40
No. 200	0 – 2

2.07 WATER FOR MOISTURE CONDITIONING

- A. Free of hazardous or toxic contaminates, or contaminants deleterious to proper compaction.

PART 3: EXECUTION

3.01 PROTECTION OF EXISTING PIEZOMETERS TO REMAIN

- A. Protect existing piezometers that are indicated to remain (as shown on drawings) from any damage incidental to the placement and compaction of fill material on the project site. Suspend work and notify the Subcontract Technical Representative (STR) immediately of damage to an existing piezometer.

3.02 GENERAL

- A. Keep placement surfaces free of water, debris, and foreign material during placement and compaction of fill and backfill materials.
- B. Place and spread fill and backfill materials in horizontal lifts of uniform thickness, in a manner that avoids segregation, and compact each lift to specified densities prior to placing succeeding lifts. Slope lifts only where necessary to conform to final grades or as necessary to keep placement surfaces drained of water.
- C. Do not place fill or backfill, if fill or backfill material is frozen, or if surface upon which fill or backfill is to be placed is frozen.
- D. If pipe, conduit, duct bank, or cable is to be laid within fill or backfill:
 - 1. Fill or backfill to an elevation 2 feet above top of item to be laid.
 - 2. Excavate trench for installation of item.
 - 3. Install bedding, if applicable, as specified in Section 31 23 33, Trenching and Backfill.
 - 4. Install item.
 - 5. Backfill the envelope zone and remaining trench, as specified in Section 31 23 33, Trenching and Backfill, before resuming filling or backfilling specified in this section.
- E. Tolerances:
 - 1. Final Lines and Grades: Within a tolerance of 0.15 foot unless dimensions or grades are shown or specified otherwise.
 - 2. Grade to establish and maintain slopes and drainage as shown. Reverse slopes are not permitted.
- F. Settlement: Correct and repair any subsequent damage to structures, pavements, curbs, slabs, piping, and other facilities, caused by settlement of fill or backfill material.

3.03 EMBANKMENT AND SELECT EARTH FILL MATERIAL

- A. Material Placement (General):
 - 1. Do not place embankment fill materials on any part of the prepared subgrade until the area has been inspected and approved by Contractor or assigned representative.
 - 2. Place and spread materials in horizontal lifts of uniform thickness.
 - 3. Do not place material in the embankment area, if the material moisture content is outside the specified limits.

4. Do not place embankment material on damaged material. Damaged material includes:
 - a. Ponded water.
 - b. Cracked soil from drying or freezing conditions.
5. Remove damaged material. Disk and compact the surface of the previously placed embankment.
6. Do not place frozen material in the embankment.
7. Do not place material on frozen subgrade.
8. Maintain the surface of the embankment level in both parallel and transfers directions of the control line, except to allow for surface drainage.
9. Key new embankments constructed on existing slopes steeper than 4:1 (horizontal run to vertical rise) with horizontal benches of sufficient width to accommodate the operation of placing and compacting equipment. Slope each bench to drain. Incorporate material excavated from the benches into the embankment fill or waste the material if directed by the Contractor.

B. Maximum Loose Lift Thickness:

1. 12 inches for material compacted with self-propelled compaction equipment.
2. 10 inches for materials compacted with hand-operated compaction equipment.
3. Reduce loose lift thickness, as necessary, to achieve compaction criteria.

C. Moisture Content:

1. Determine the optimum moisture content by ASTM D698.
2. Embankment Fill: Place and compact at moisture content at least 2 percentage points higher than the optimum moisture but not greater than 7 percent points higher than the optimum moisture content. Adjustments to moisture content can be made if the Subcontractor can demonstrate to the Contractor that minimum compaction can be achieved.
3. Excavated Limestone or Shale Bedrock: Place and compact at a moisture content between 1 percent below and 3 percentage points higher than the optimum moisture content for the processed material.
4. Moisture condition embankment materials obtained from borrow sites within the borrow area prior to placement within the embankment. No more than 1 percentage point water shall be added to the embankment materials already placed, but not yet compacted, within the embankment limits.

D. Compaction:

1. General:

- a. Compact each lift prior to placement of succeeding lifts.
- b. When hauling equipment is operated on the embankment lifts, evenly distribute the traffic across the entire embankment width to prevent nonuniform compactive effort.

2. Equipment:

- a. Use compaction equipment of size and type capable of producing the required densities.
- b. Self-propelled rollers shall have functioning speedometers.
- c. Equipment for compacting imported materials shall be clean and shall not contaminate the imported materials.

3. Method and Density Requirements:

- a. Compact to dry density that is greater than or equal to 95 percent of the maximum dry density, as determined by ASTM D698.
- b. Finish the compaction of each lift with a minimum of four passes using a self-propelled tamping-foot roller having a minimum operating weight of 65,000 pounds. The roller shall have chevron-shaped tamping feet with 7-inch minimum length. Roller speed shall not exceed 5 miles per hours when compacting soil.

3.04 SITE TESTING

A. Gradation:

1. One sample from each 175 cubic yards of sand infill to be installed.
2. One sample from each 1,500 tons of structural fill, select earth fill, embankment fill, and granular drain material, or more often as determined by Contractor's Engineer, if variation in gradation is occurring, or if material appears to depart from specifications.
3. If test results indicate material does not meet specification requirements, terminate material placement until corrective measures are taken.
4. Remove placed fill material that does not meet specification requirements.

B. In-Place Density Test Frequency

1. One test per 5,000 square feet, or fraction thereof, of each lift of fill or backfill compacted by heavy equipment.
2. One test per 2,500 square feet, or fraction thereof, of each lift of fill or backfill areas compacted by hand-operated machines.
3. Check Tests on In-Place Densities: If ASTM D6938 is used, check the in-place densities by ASTM D1556 or ASTM D2937 with frequency of one check test per lift for each 50,000 square feet, or fraction thereof, of each lift of compacted fill or backfill.

C. In-Place Density Test Results

1. In accordance with ASTM D6938. During placement of materials, test as follows:
 - a. Embankment Fill: 93 percent of maximum dry density per ASTM D698.
 - b. Structural Fill: 95 percent of maximum dry density per ASTM D698.
 - c. Select Earth Fill: 95 percent of maximum dry density per ASTM D698.
 - d. Base Course Rock: 93 percent of maximum dry density per ASTM D698.

3.05 MINERAL AGGREGATE BASE COURSE

- A. Place and compact as specified in Section 32 11 23, Aggregate Materials.

3.06 REPLACING OVEREXCAVATED MATERIAL

- A. Replace excavation carried below grade lines shown or established by Contractor's Engineer as follows:
1. Beneath Fill or Backfill: Same material as specified for overlying fill or backfill.
 2. Trenches:
 - a. Unauthorized Overexcavation: Either trench stabilization material or granular pipe base material, as specified in Section 31 23 33, Trenching and Backfill.

- b. Authorized Overexcavation: Trench stabilization material, as specified in Section 31 23 33, Trenching and Backfill.
3. Permanent Cut Slopes (Where the Overlying Area will not receive fill or backfill):
- a. Flat to Moderate Steep Slopes (3:1 or Flatter, H:V): Earth Fill.
 - b. Steep Slopes (Steeper than 3:1): Correct overexcavation by transitioning between overcut areas and designed slope adjoining areas, provided such cutting does not extend offsite or outside easements and rights-of-way, or adversely impacts existing facilities, adjacent property, or completed site project work.

3.07 BACKFILL FOR COVER SYSTEM ANCHOR TRENCH

- A. Cover system anchor trenches shall be backfilled with selected earth fill as shown on construction drawings, placed in 8-inch maximum lifts, and compacted to 95 percent relative compaction. HDPE geomembrane seam welds shall extend through the anchor trench to the bottom of the welded sheets. Extend engineered turf also through trench zone as shown.

3.08 PLACING FILL OVER GEOSYNTHETICS

A. General:

- 1. Prior to placing material over geosynthetics, notify Subcontract Technical Representative (STR). Do not cover installed geosynthetics until after the STR provides authorization to proceed.
- 2. Do not place materials on geosynthetics where typical height of wrinkles is greater than 2 inches and spacing between wrinkles is less than 10 feet. Also, do not place soil materials in manner that will cause wrinkles to fold over or become confined to form a vertical ridge.
- 3. Place soil materials when geosynthetics are cool and contracted and wrinkles are minimized.
- 4. If tears, punctures, or other geosynthetics damage occurs during placement of overlying material, remove overlying products as necessary to expose damaged geosynthetics, and repair damage as specified in Section 32 05 21, Geomembrane and Engineered Turf Cover System.
- 5. Geosynthetics installer shall remain available during placement of overlying products to repair geosynthetics if damaged.
- 6. Place fill over geosynthetics with sufficient care so as not to damage them.
- 7. Place fill only by back dumping and spreading only.

8. Dump fill only on previously placed fill.
 9. While operating equipment, avoid sharp turns, sudden starts or stops that could damage geosynthetics.
- B. Hauling: Operate hauling equipment on minimum of 3 feet of covering.
- C. Spreading:
1. Spreading equipment shall be track mounted , low ground pressure, D6 dozer or lighter.
 2. Operate spreading equipment on minimum of 12 inches of fill over geosynthetics.
 3. Spread fill in same direction as unseamed overlaps to avoid separation of seams and joints.
 4. Never push fill downslope toward the geosynthetics. Spread fill over sideslopes by pushing up from slope bottom, and allowing the material to fall down the face of spread material. If access to bottom of slope is unavailable, progressively place fill, beginning at toe of slope and working upslope, with backhoe or dragline operated from top of slope. Limit distance material falls onto the geosynthetics to maximum of 2 feet.
 5. Always have a thickened layer at the edge of the leading edge of the fill. As the leading edge propagates, the thickened lift of material can be cut down to the desire lift thickness.
 6. Maintain proper overlap of unseamed geosynthetics.
 7. Avoid overstressing geosynthetics and seams.
- D. Compaction: Compact fill only after uniformly spread to full thickness shown.
1. Place materials that require density testing in lifts of 8 inch maximum thickness and compact each lift to minimum of 95 percent relative compaction as determined in accordance with ASTM D698.
- E. Geosynthetic Damage:
1. Mark punctures, tears, or other damage to geosynthetics, so repairs may be made.
 2. Clear overlying fill as necessary to repair damage.
 3. Repairs to geosynthetics shall be made by respective installers as specified in respective specification section for each geosynthetic.

3.09 SAND INFILL MATERIAL PLACEMENT

- A. No equipment is allowed on slopes steeper than 3:1 (H:V) after placement of engineered turf and prior to placement of sand infill.
- B. A low-ground-pressure all-terrain utility vehicle with maximum load of 2000 lbs may travel on side slopes during construction, provided that this vehicle only travels up slope without sudden turns or stops.
- C. Do not place sand infill when snow or ice is present on the engineered turf component.
- D. Place and spread materials to lines and grades shown and as specified in paragraph 3.08. Sand infill layer will be placed to a 1/2 inch minimum thickness not to exceed 3/4 inch thick, measured with a digital caliper, or alternate measuring device approved by Contractor's Engineer. Final thickness of the sand infill will be checked at a minimum 20 times per acre.
- E. Sand infill shall be worked into the engineered turf between the synthetic yarn blades. Placement of sand infill shall be in front of the deployment equipment. Conveyor systems and/or express blowers will be used to place and spread the sand infill. After sand infill placement, use low ground pressure equipment (maximum 4 psi ground pressure) with rake or similar attachment to rake and spread sand infill to a uniform thickness.
- F. Verify no geosynthetics are damaged or exposed after installation of sand infill is complete.

3.10 SURVEYING AND INSPECTION

- A. Subcontractor shall provide and maintain a means of continuously observing the depth of each material such as by full GPS automatics until placement and spreading is complete. Sharp stakes or methods that could damage the geosynthetics will not be allowed. Subcontractor shall provide and operate suitable equipment to assist Contractor's Engineer's checking of material depths on an approximate 50 foot grid at no additional cost to Contractor.
- B. During material placement and spreading operations, the Contractor's Engineer may be monitoring geomembrane movement and integrity. At the Contractor's Engineer's request, the Subcontractor shall uncover and then backfill after approval up to twenty 2-foot square areas over the course of the project at no additional cost to the Contractor.

3.11 ACCESS ROAD MINERAL AGGREGATE BASE COURSE

- A. Place and compact as specified in Section 32 11 23, Aggregate Materials.

END OF SECTION

**SPECIFICATION
 FOR
 SECTION 32 05 21
 GEOMEMBRANE AND ENGINEERED TURF COVER SYSTEM
 GROUNDWATER FIELD DEMONSTRATION (GWFD)**

		JOB NO.	
		SPECIFICATION NO.	SPC-OSWDF-I-309
		SHEET	1 of 23
	Name	Signature	Date
Originator	Ken Oliver, PE		6/06/2023
Checker	David Matlock, PE		6/06/2023
Additional Reviewer	Butch Parton, PE		6/06/2023
Additional Reviewer			
Project Engineer	Greg Pickerel, PE		

Revision History		
Rev. No.	Reason For Revision	Date
0	Issued For Construction	6/06/2023



Form-362 (02/23) Rev. 3
 PROC-DE-1007

SECTION 32 05 21
GEOMEMBRANE AND ENGINEERED TURF COVER SYSTEM

PART 1: GENERAL

1.01 DESCRIPTION

- A. This section covers requirements to furnish and install pre-engineered geomembrane and engineered turf components for the cover system as indicated on the construction drawings.

1.02 REFERENCES

- A. The following is a list of standards which may be referenced in this section:
1. ASTM International (ASTM):
 - a. ASTM D792, Standard Test Methods for Density and Specific Gravity (Relative Density) of Plastics by Displacement
 - b. ASTM D882, Standard Test Method for Tensile Properties of Thin Plastic Sheeting
 - c. ASTM D1004, Standard Test Method for Tear Resistance (Graves Tear) of Plastic Film and Sheeting
 - d. ASTM D1238, Standard Test Method for Melt Flow Rates of Thermoplastics by Extrusion Plastometer
 - e. ASTM D1505, Standard Test Method for Density of Plastics by the Density-Gradient Technique
 - f. ASTM D2240, Standard Test Method for Rubber Property-Durometer Harness
 - g. ASTM D4833, Standard Test Method for Index Puncture Resistance of Geotextiles, Geomembranes, and Related Products
 - h. ASTM D5199, Standard Test Method for Measuring Nominal Thickness of Geosynthetics
 - i. ASTM D5321, Standard Test Method for Determining the Coefficient of Soil and Geosynthetic or Geosynthetic and Geosynthetic Friction by the Direct Shear Method
 - j. ASTM D5641, Standard Practice for Geomembrane Seal Evaluation by Vacuum Chamber
 - k. ASTM D5994, Standard Test Method for Measuring Core Thickness of Textured Geomembrane
 - l. ASTM D6392, Standard Test Method for Determining the Integrity of Nonreinforced Geomembrane Seams Produced Using Thermo-Fusion Methods

- m. ASTM D6693, Standard Test Method for Determining Tensile Properties of Nonreinforced Polyethylene and Nonreinforced Flexible Polypropylene Geomembranes

2. Geosynthetics Research Institute (GRI):

- a. GM6, Practice for Pressurized Air Channel Test for Dual Seamed Geomembranes
- b. GM10, Specification for the Stress Crack Resistance of HDPE Geomembrane Sheet
- c. GM13, Standard Specification for Test Methods, Test Properties and Testing Frequency for High Density Polyethylene (HDPE) Smooth and Textured Geomembranes
- d. GM19, Specification for Seam Strength and Related Properties of Thermally Bonded Polyolefin Geomembranes/Barriers

1.03 DEFINITIONS

- A. Boot: Watertight collar fabricated from geomembrane sheet for sealing geomembrane to pipes and other objects that penetrate geomembrane.
- B. Film Tearing Bond: Failure in ductile mode of one bonded sheet, by testing, prior to complete separation of bonded area.
- C. Engineered Turf: Synthetic turf comprised of polyethylene fibers tufted through a double layer of woven polypropylene geotextile backing.
- D. Geomembrane: Essentially impermeable geosynthetic composed of one or more layers of polyolefin materials fusion bonded into single-ply integral sheet.
- E. Panel: Piece of geomembrane composed of two or more sheets seamed together.
- F. Sheet: Seamless piece of geomembrane.
- G. Watertight: Geomembrane installation free of flaws and defects that will allow passage of water and gases, liquids, and solids to be contained under anticipated service conditions.

1.04 SUBMITTALS

- A. The following documents shall be submitted to the Subcontract Technical Representative (STR) in accordance with the requirements of Exhibit I of the Subcontract.
 - 1. Pre-Construction Quality Submittals
 - a. Qualifications for:
 - 1) Geomembrane Manufacturer

- 2) Geomembrane Installer
 - 3) Geomembrane Independent Testing Agency
 - b. Qualifications for:
 - 1) Engineered Turf Manufacturer
 - 2) Engineered Turf Installer
 - 3) Independent Testing Agency for Engineered Turf
 - c. Quality Assurance Program for Geomembrane: Written description of geomembrane Manufacturer's and Installer's formal programs for manufacturing, fabricating, transport, handling, installing, seaming, testing, and repairing geomembrane.
 - d. Quality Assurance Program for Engineered Turf: Written description of engineered turf Manufacturer's and Installer's formal programs for manufacturing, fabricating, transport, handling, installing, seaming, testing, and repairing engineered turf.
 - e. Product samples of the geomembrane and engineered turf components.
2. Other Pre-Construction Submittals:
- a. Manufacturer's specifications, literature, certificate of compliance for each Geomembrane that is furnished. Include incidental materials and products used to assist and complete installation.
 - b. Manufacturer's specifications, literature, certificate of compliance for each Engineered Turf that is furnished. Include incidental materials and products used to assist and complete installation.
 - c. Geomembrane:
 - 1) Compensation allowance calculation and numerical values for temperature-induced geomembrane expansion and contraction.
 - 2) Polymer Resin: Product identification and Supplier.
 - 3) Production dates and factory quality test results.
 - 4) Proposed equipment for material placement.
 - 5) Geomembrane sheet layout with proposed sizes, numbers, position, and sequence of sheet placement, and proposed location of field seams.
 - 6) Factory QC test results for supplied Geomembrane.

- 7) Certified factory seam test results for Geomembrane.
- e. Engineered Turf:
 - 1) Production dates and factory quality test results.
 - 2) Proposed equipment for material placement.
 - 3) Engineered Turf sheet layout with proposed sizes, numbers, position, and sequence of sheet placement, and proposed location of field seams.
 - 4) Factory QC test results for supplied Engineered Turf.
- 3. Inspections and Test Reports:
 - a. Documented meeting minutes and procedures agreed upon from project coordination meetings and installation demonstrations.
 - b. Daily field inspection notes and checklists.
 - c. Certified field seam test results.
- 4. Closeout Submittals
 - a. Special guarantee requirements listed in paragraph 1.11.
 - b. Geomembrane Installer’s Certification of Subsurface Acceptability: Form attached at end of this section.
 - c. Geomembrane Manufacturer’s Certificate of Proper Installation.
 - d. Geomembrane Record Documents: Include panel and sheet numbers, seaming equipment and operator identification, temperature and speed setting of equipment, date seamed, identify and location of each repair, cap strip, penetration, boot and sample taken from installed Geomembrane for testing.
 - e. Engineered Turf Record Documents: Include panel and sheet numbers, seam locations, date seamed, identify and location of each repair, cap strip, penetration, and sample taken from installed Engineered Turf for testing.

1.05 QUALIFICATIONS

- A. Independent Testing Agency: Minimum of five years experience in field of geomembrane testing. Laboratory must be certified by an independent agency or organization such as the Geosynthetic Accreditation Institute—Laboratory Accreditation Program for the specified testing and shall maintain calibrated instruments, equipment, and documented standard procedures for performing specified testing.

- B. Manufacturer: Successfully manufactured a minimum of 10 million square feet of each type of geomembrane material specified.
- C. Installer: Successfully installed a minimum of 10 million square feet of each type of geomembrane product specified in applications similar to the Project.
- D. Minimum qualifications stated above will be deemed met if the firm or cumulative experience of key personnel (supervisors and trained installation/testing technicians) proposed for this Project has minimum experience specified. If key personnel provision is used to qualify the firm, submit letter stating key personnel meet the minimum experience requirements and those individuals are available for and will be committed to this Project.

1.06 COORDINATION MEETINGS

- A. Meet at least once prior to commencing each of the following activities:
 1. Preconstruction and submittals.
 2. Fabrication of panels and boots.
 3. Installation of Geomembrane.
 4. Installation of Engineered Turf.
- B. Attendees:
 1. Subcontractor-designated quality control representative.
 2. Subcontract Technical Representative.
 3. Contractor's Engineer.
 4. Representatives of geomembrane installer.
 5. Others requested by Contractor's Engineer.
- C. Topics:
 1. Construction drawings and construction specifications.
 2. Submittal requirements and procedures.
 3. Schedule for beginning and completing geomembrane installation.
 4. Training for installation personnel.
 5. Installation crew size.
 6. Establishing geomembrane marking system, to include sheet identification, defects, and satisfactory repairs, to be used throughout Work.
 7. Quality assurance.

1.07 INSTALLATION DEMONSTRATIONS

- A. Seam Installation and Testing Demonstration: Performed by geosynthetic installer, for each type of seam required, a minimum of 3 days prior to placement of product.
- B. Attendees: As required for Coordination Meetings.

1.08 DELIVERY, STORAGE, AND HANDLING

- A. Geomembrane and Artificial Turf:
 - 1. Individually package each sheet and protect from damage during shipment.
 - 2. Mark each package with identification of material type, size, and weight.
 - 3. Dragging panels on ground surface is not permitted.
 - 4. Do not fold geomembrane component material.
 - 5. Store rolls on a clean, dry surface or on dunnage.

1.09 ENVIRONMENTAL REQUIREMENTS

- A. Do not install geomembrane, artificial turf, or perform seaming under the following conditions, unless it can be demonstrated to satisfaction of Contractor's Engineer that performance requirements can be met under these conditions:
 - 1. Air temperature is less than 35 degrees F or more than 90 degrees F.
 - 2. Relative humidity is more than 90 percent.
 - 3. Raining, snowing, frost is in ground, or wind is excessive.
- B. Do not place granular materials on geomembrane or artificial turf when ambient temperature is less than 35 degrees F, unless it can be demonstrated to satisfaction of Contractor's Engineer that materials can be placed without damage.

1.10 SEQUENCING AND SCHEDULING

- A. Before placing geomembrane on soil surfaces, prepare subgrade as specified in Section 31 23 13, Subgrade Preparation, and Section 31 23 23, Fill Material and Placement.

1.11 SPECIAL GUARANTEE

- A. Provide manufacturer's extended guarantee or warranty, with the Owner (U.S. Department of Energy) named as the beneficiary, in writing, as special guarantee. Special guarantee shall provide for correction, or at option of the Owner, removal and replacement of Work specified in this specification section that is found defective during the periods below, commencing on date of Substantial Completion.

1. Guarantee the geomembrane against manufacturing defects, deterioration as a result of ozone, ultraviolet, and other exposure to elements for period of 20 years on pro rata basis.
2. Guarantee the geomembrane against defects in material and factory seams for period of 2 years.
3. Guarantee the geomembrane against defects resulting from installation for period of 2 years.

PART 2: PRODUCTS

2.01 MATERIALS

- A. The Subcontractor shall furnish all materials, tools, and equipment as required to transport, deliver, handle, install, and protect Geomembranes and Engineered Turf Cover Systems on the project site.

2.02 ACCEPTABLE MANUFACTURERS

- A. Geomembrane: AGRU America, Georgetown, SC.
Or manufacturer of equivalent ability, that is approved by the Contractor.
- B. Engineered Turf: WatershedGeo, Alpharetta, GA.
Or manufacturer of equivalent ability, that is approved by the Contractor.

2.03 GEOMEMBRANE

- A. Product: 50 mil Super Gripnet® textured HDPE geomembrane.
Or an equivalent product, that is approved by the Contractor.
- B. Composition:
 1. High Density polyethylene (HDPE) containing no plasticizers, fillers, extenders, reclaimed polymers, or chemical additives, except the following:
 - a. Approximately 2 percent by weight of carbon black to resin for ultraviolet resistance.
 - b. Antioxidants and heat stabilizers, not to exceed 1.5 percent total by weight, may be added as required for manufacturing.
- C. Furnish in rolled, single-ply, continuous sheets with no factory seams.
- D. Sheet Thickness: Specified nominal thickness is 50 mil. Minimum values determined in accordance with ASTM D5199 and shall not include ridges of textured geomembrane.

- E. Sheet Width: Minimum 22 feet.
- F. Roll Length: Longest that will be manageable and reduce field seams.
- G. Textured HDPE Geomembrane: Manufactured so that surface irregularities that produce specified friction are adequately fused into sheet or are extruded with sheet, on both sides of sheet. Texture is to be in addition to base thickness specified for sheet.
- H. Meet manufacturer's most recent specifications and required minimum textured HDPE geomembrane values in Table 1.

Table 1 Textured HDPE Geomembrane Properties		
Property	Requirement (MARV)	Test Method
Thickness (min. avg.)	47.5 mil	ASTM D5199, Modified Note 1, or ASTM D5994
Asperity Height (min, avg.)		ASTM D7466
1. Drainage Stud 2. Friction Spike	130 mil 175 mil	
Density	0.94 g/cc	ASTM D792, Method B
Tensile Properties (avg. both directions) 1. Tensile Stress @ Break 2. Tensile Stress @ Yield 3. Elongation @ Break 4. Elongation @ Yield	110 lb./in width 110 lb./in width 200% 12%	ASTM D6693, Type IV
Puncture Resistance	80 lb.	ASTM D4833
Tear Resistance	38 lb.	ASTM D1004, Die C
Carbon Black Content (%)	2 to 3	ASTM D4218
Oven Aging at 200°C Standard OIT (min. avg.) - % retained after 90 days	140	ASTM 3895
Environmental Stress Crack Resistance	500 hours	ASTM D5397 Single Point NCTL Test
Note 1: Commercially available micrometers may be used that have a 60-degree taper to a point with a radius of 1/32 inch. Subcontractor shall make enough measurements of thinner areas of textured sheet to develop statistical basis for thickness.		

- I. Geomembrane shall meet the following manufacturer quality control (MQC) requirements:

1. Geomembrane manufacturer shall continuously monitor geomembrane during manufacturing process for inclusions, bubbles, or other defects. Geomembrane that exhibits any defects will not be accepted.
2. Geomembrane manufacturer shall continuously monitor geomembrane thickness during manufacturing process. Geomembrane that fails to meet specified minimum thickness will not be accepted.
3. Geomembrane manufacturer shall sample and test geomembrane in accordance with values specified in Table 1 (manufacturer's specification for 50-mil Super Gripnet geomembrane).
4. Samples of geomembrane shall be taken across the entire width of roll.

2.04 ENGINEERED TURF COMPONENT

- A. Product: ClosureTurf®.
Or an equivalent product, that is approved by the Contractor.
- B. A synthetic structured material consisting of one or more geotextiles tufted with polyethylene yarns that resemble grass blades.
- C. Sheet Width: Minimum 14 feet.
- D. Roll Length: Longest that will be manageable and reduce field seams.
- E. Yarn Color: Green.
- F. Meet the manufacturer's most recent published specifications and required values in Table 2.

Table 2 Engineered Turf Properties		
Property	Requirement (MARV)	Test Method
Total Product Weight (minimum)	20 oz/sq. yd.	ASTM D5261
CBR Puncture	1500 lb.	ASTM D6241
Tensile Strength of Product 1,600 XD 2,100 MD	1,600 lb./ft	ASTM D4595
Tensile Strength of Yarn	15 lb.	ASTM D2256
Interface Friction Between Engineered Turf and Textured Geomembrane (min. Peak)	35°	ASTM D5321
UV Stability (retained strength at 100 years projected)	>60%	ASTM G147

2.05 GEOMEMBRANE EXTRUDATE

- A. Extrudate shall be made from the same resin as the geomembrane.
- B. Additives shall be thoroughly dispersed in the extrudate.
- C. Additives shall be free of contamination by moisture or foreign matter.

2.06 GEOMEMBRANE FIELD SEAMS

- A. Approved processes for seaming are extrusion welding and fusion welding.
- B. Every seaming apparatus must be specifically approved by make and model before use.
- C. Proposed alternate processes shall be documented and submitted for approval.
- D. Passing criteria for geomembrane seams are established by GM-19 and shall meet the required values in Table 3.

Table 3 HDPE Geomembrane (Textured) Minimum Seam Properties			
Property	Unit	Specified Value	Test Method
Shear Strength	lbs/inch width	100 at FTB	ASTM D6392
Shear Elongation at Break	%	50 at FTB	ASTM D6392
Peel Strength, Fusion Weld	lbs/inch width	76 at FTB	ASTM D6392
Peel Strength, Extrusion Weld	lbs/inch width	65 at FTB	ASTM D6392
Peel Separation	%	25	ASTM D6392
Note: Film Tear Bond (FTB) is defined as failure of one of the sheets by tearing, instead of separating from the other sheet at the weld interface area (such as, sheet fails before the weld fails).			

- E. Passing criteria for artificial turf are established by manufacturer installation guidelines and must comply with visual passing criteria. Visual passing criteria shall be established at the preconstruction seam and testing demonstration.

2.07 BOOTS

- A. Fabricated of same material as geomembrane sheets to fit around penetrations, without folds, stretching, or unsupported areas.

- B. Flanges:
 - 1. Angle: Match slope or bottom where penetration passes through liner.
 - 2. Width: Minimum 2 feet, plus dimension of penetration.

2.08 SEALANT CAULKING

- A. Two-component sealant formulated of 100 percent polyurethane elastomer, such as Elastuff 120 Mastic as supplied by United Paint and Coatings, Greenacre, WA. Or an equivalent product, that is approved by Contractor Engineering.
- B. Butyl rubber sealant such as Butylgrip Sealant, supplied by the Biddle Company, St. Louis, MO. Or an equivalent product, that is approved by Contractor Engineering.

2.09 STAINLESS STEEL BANDS

- A. As manufactured by Breeze Clamp Products, Saltsburg, PA. Or an equivalent product, that is approved by the Contractor.

2.010 ALUMINUM CLAMP MATERIAL

- A. In accordance with ASTM B211, Alloy 5052, Temper H32.
 - 1. Strips: 2 inches wide by 1/4-inch-thick.
 - 2. Channel: 2 inches wide by 1/8-inch-thick.

2.011 NEOPRENE RUBBER PAD

- A. Compression Strip Beneath Battens:
 - 1. 2 inches wide by 1/4-inch-thick.
 - 2. 35 durometer to 45 durometer, in accordance with ASTM D2240 hardness.
- B. Contact Cement: As recommended by neoprene rubber pad manufacturer.
- C. Manufacturer: Aero Rubber Co., Inc., Bridgeview, IL.

2.012 PROTECTIVE FOAM

- A. Medium to high-density rigid board.
- B. Manufacturers and Products:
 - 1. General Plastics Manufacturing Corp, Tacoma, WA; Polyurethane Last-a-Foam.
 - 2. Dow Chemical Corp., Midland, MI; Polyethylene Ethafoam.
 - 3. Or an equivalent product, that is approved by the Contractor.

2.013 GEOMEMBRANE MANUFACTURER'S CONFORMANCE TESTING

A. Resin Quality Documentation:

1. Prior to geomembrane and engineered turf component delivery and installation, manufacturer shall provide Subcontract Technical Representative (STR) with the following information:
 - a. Origin (resin supplier's name, resin production plant), (identification brand name, number), and production date of resin.
 - b. Copy of quality control certificates issued by resin supplier noting results of density and melt index.
 - c. Reports on tests conducted by manufacturer to verify quality of the resin used to manufacture the geomembrane rolls assigned to the project facility (these tests should include specific gravity (ASTM D792 Method A or ASTM D1505) and melt index (ASTM D1238 Condition 190/2.16).
 - d. Reports on the tests conducted by the manufacturer to certify the quality of the sheet.

B. Property Conformance Documentation:

1. Prior to liner delivery and installation, manufacturer shall provide Contractor with the following:
 - a. Properties sheet including, at a minimum, all specified properties, measured using test methods indicated in the specification or equivalent.
 - b. Contractor's Engineer will verify that:
 - 1) Property values certified by the geosynthetic manufacturer meet all of the requirements in these specifications.
 - 2) Measurements of properties by geosynthetic manufacturer are properly documented and the test methods used are acceptable.

C. Geosynthetic Roll Documentations: Prior to shipment, manufacturer shall provide Subcontract Technical Representative (STR) with one quality control certificate for every roll of geosynthetic provided. Quality control certificate shall be signed by manufacturer's responsible party. Quality control certificate shall include at a minimum:

1. Roll numbers and identification.
2. Results of quality control tests. As a minimum, ASTM test methods shall be used to test for thickness, tensile strength, and tear resistance.

PART 3: EXECUTION

3.01 PREPARATION

- A. Geomembrane Inspection: During delivery and unwrapping, visually inspect and mark each imperfection for repair.
- B. Do not place geomembrane until condition of subgrade or geosynthetics installed is acceptable to the Contractor's Engineer.
- C. Subgrade: Maintain in smooth, uniform, and compacted condition as specified in Section 31 23 13, Subgrade Preparation, during installation of geomembrane.

3.02 WELDING UNITS

- A. Double hot-wedge fusion seam welding.
- B. Extrusion welding systems.
- C. Hot-air welding is not acceptable.

3.03 TENSIO METER FOR FIELD TESTING

- A. Motor-driven with jaws capable of traveling at measured rate of 20 inches per minute.
- B. Equipped with gauge which measures force in unit pounds exerted between jaws.
- C. As recommended by HDPE geomembrane manufacturer.
- D. The field tensiometer must have a valid calibration for the provided model and serial number. The certificate must include the next calibration due date.

3.04 GEOMEMBRANE AND ENGINEERED TURF INSTALLATION

- A. Prepare geomembrane liner subgrade as specified in Section 31 23 23, Fill Material and Placement, and Section 31 23 13, Subgrade Preparation.
- B. Do not install geomembrane or engineered turf or seam unless Subcontractor can demonstrate successful performance and test results showing seams meet strength specifications. No seaming shall take place unless environmental requirements are satisfied in accordance with paragraph 1.09.
- C. Install the geomembrane and engineered turf cover system in areas shown on construction drawings. No geomembrane or engineered turf material shall be seamed unless environmental conditions are as specified in paragraph 1.09, unless the Subcontractor can demonstrate to the Contractor's Engineer's satisfaction that installation techniques compensate for these conditions.

- D. Install the geomembrane and engineered turf cover system in accordance with the approved Shop Drawings. Any deviations must be documented in writing and approved by the Contractor prior to field installation.
- E. Sheets of geomembrane and engineered turf shall be of such lengths and widths and shall be placed in such a manner as to reduce field seaming to a minimum. Sheets shall be placed parallel to slopes to minimize horizontal seams. Seams parallel to any toe of slope shall be at least 5 feet from the toe.
- F. Factors such as expansion, contraction, overlap at seams, anchorage requirements, seaming progress, and drainage shall be considered. Textured-surface sheets shall be aligned in a manner which maximizes their frictional capabilities along the slope. Maneuver sheets of geomembrane and engineered turf into place in a manner which prevents wrinkles, folds, or similar distress which can damage the geomembrane or prevent its satisfactory alignment or seaming.
- G. Sandbags shall be used as necessary to temporarily anchor or hold the geomembrane and engineered turf in position during installation. Sandbag fabric shall be sufficiently close knit to preclude fines from working through the bags. Tires and paper bags, whether or not lined with plastic, shall not be used. Burlap bags, if used, shall be lined with plastic. Bags shall be securely closed after filling to prevent sand loss. Bags that are split, torn, or otherwise losing their contents shall be immediately removed from the work area and any spills immediately cleaned up.
- H. Anchor the perimeter of the geomembrane and engineered turf as shown on construction drawings, or as otherwise approved in writing by the Contractor. Protect the geomembrane and artificial turf from equipment and other hazards and keep it clean and free of all debris during placement. Protect the geomembrane and artificial turf from uplift by wind and other damage prior to seaming, anchoring, or attachment of the edges of the geomembrane.
- I. Anchor and seal the geomembrane to structures, pipes, and other types of penetrations in accordance with details shown on construction drawings.
- J. Take extreme care during installation of the geomembrane and engineered turf to be certain no damage is done to any part of the liner system. Prohibit smoking at the Site by installation personnel. Handling and installation procedures shall be performed by workers wearing smooth-soled footwear. No vehicular traffic shall be allowed on the geomembrane surface. Motor-driven equipment using fuel shall have spark arresters. No gasoline-driven generators or cans of flammable liquid shall be placed on the lining or in close vicinity. Under no circumstances shall the geomembrane surface be used as a work area, for preparing patches, storing tools and supplies, or other uses. If needed, a protective cover shall be spread out as a work surface, to prevent damage to the cover system.

- K. Compensation allowance for the temperature-induced expansion and contraction of geomembrane must be submitted to the Contractor prior to placement of operations layer over the geomembrane, as specified herein.

3.05 FIELD SEAMS

A. General:

1. Seam coding system shall be compatible with panel coding system.
2. Seams shall be oriented parallel to the line of maximum slope, for example, oriented up and down, not across, the slope to the maximum extent practical. In corners and odd-shaped geometric locations, the number of seams shall be minimized.

B. Geomembrane:

1. Use lap joints to seal geomembrane sheets together in the field. Field seams shall be made on a supporting smooth surface. Form the seams by lapping the edges of sheets a minimum of 4 inches. Wipe contact surfaces of the sheets clean to remove dirt, dust, moisture, and other foreign materials and prepare in accordance with the installer's seaming method approved by the Contractor. Avoid seam intersections involving more than three thicknesses of geomembrane material. Offset seam intersections at least 2 feet. Extend the seams to the ends of the geomembrane sheets through the anchor trench, boots, and mechanical attachments.
2. For seams where extrusion welds are used and where it will be impracticable to perform a vacuum test, insert copper wire for spark test, prior to welding. Position to within 1/8 inch of sheet edge.
3. Seams shall not go through a boot. Locate seams a minimum of 2 feet from boot.
4. Seam the geomembrane sheets together, using the extrusion and/or double hot-wedge fusion system, equipment, and techniques.
5. Fishmouths or wrinkles at seam overlaps shall be cut to achieve a flat overlap.
6. The cut fishmouths or wrinkles shall be extrusion welded or patched where the overlap is more than 3 inches.
7. When capping of a field seam is required, use a cover strip cap of the same thickness as the geomembrane (and from the same roll, if available) and of 8-inch minimum width. Position the cap strip over the center of the field seam and weld to the geomembrane using a fillet weld each side, including a copper wire as described above for spark testing.
8. Prior to starting the production welding, trial welds must be performed and tested.

9. Trial Weld Testing:
 - a. Five 1-inch-wide test strips shall be cut from the trial weld.
 - b. Each of the specimens shall be tested in the field for peel and shear using a digital tension meter. Four out of five specimens must meet the minimum requirements for field seam acceptance. The test results shall be verbally reported to the Subcontract Technical Representative (STR) within 1 hour of testing. The results shall be provided in writing to the Subcontract Technical Representative (STR) within 24 hours of testing.
 - c. Remaining sample shall be retained for future testing.
 - d. A trial weld specimen will pass when the results are achieved for both peel and shear tests as specified herein. For double-wedge welding, both welds shall be individually tested and both shall be required to pass in peel.
 - e. Seaming apparatus or seamer shall not be accepted and shall not be used for seaming until deficiencies are corrected and consecutive full trial seams are achieved.

C. Engineered Turf:

1. Fusion seams require a minimum of 5 inches of overlap.
2. Cut off or remove frayed or loose geotextile strands.
3. Prior to starting the production fusion seaming, perform trial seams.
4. Demonstrate the preparation methods and equipment utilized for removal of the selvage from the outside edge of the rolls of turf (trimming and cutting devices).
5. Mechanical or hot knife trimming and cutting devices will be utilized for selvage trimming.
6. Demonstrate and control the fraying of geotextile strands when performing the removal of selvage.
7. Any damage that occurs due to production seaming will be repaired.

D. Trial Welds and Seams:

1. Trial welds and seams shall be performed on geomembrane and engineered turf samples to verify welding/seaming equipment operations and performance of seaming methods and conditions.
2. Minimum of one trial seam per day or shift per welding/seaming apparatus and operator shall be made, one made prior to the start of work and one completed at mid shift. Results shall be submitted to the Subcontract Technical Representative (STR) at the end of each day.

3. Welds and seams shall be made under the same surface and environmental conditions as the production welds and seams (such as, in contact with geomembrane subsurface and similar ambient temperature).

3.06 PLACING PRODUCTS OVER GEOSYNTHETICS

- A. Sand Infill is specified in Section 31 23 23, Fill Material and Placement.
- B. Engineered turf shall be placed over the completed portions of the geomembrane cover within 10 work days of geomembrane installation.
- C. Do not place engineered turf in a manner that will cause wrinkles to fold over or be confined to form a vertical ridge. Maximum wrinkle height shall be 2 inches and a minimum wrinkle spacing shall be 10 feet prior to placement of the operations layer over geomembrane.

3.07 REPAIRING GEOSYNTHETICS

- A. Geosynthetics shall be examined for defects, holes, blisters, undispersed raw materials, and any sign of contamination by foreign matter.
- B. Geosynthetic surface shall be clean at the time of the examination.
- C. Each suspect location shall be repaired and non-destructively tested.
- D. Subcontractor shall be responsible for repair of damaged or effective areas. One of the procedures listed below shall be recommended by the Subcontractor and approved by the Contractor's Engineer:
 1. Patching: Used to repair large holes (over 3/8-inch diameter), tears (over 2 inches long), undispersed raw materials, and contamination by foreign matter.
 2. Abrading and Rewelding: Used to repair small seam sections (less than 12 inches long).
 3. Spot Welding: Used to repair small tears (less than 2 inches long), pinholes, or other minor, localized flaws.
 4. Capping: Used to repair large lengths of failed seams.
 5. Removing unsatisfactory material and replacing with new material.
- E. Geosynthetic surfaces to be repaired shall be abraded (extrusion welds only) no more than 1 hour prior to the repair.
 1. Patches or caps shall extend at least 6 inches beyond the edge of the defect, and all corners of material to be patched and the patches shall be rounded to a radius of at least 4 inches.

2. Geomembrane below large caps shall be cut to avoid water or gas collection between the two sheets.
- F. Prepare contact surfaces and seam patch in accordance with paragraph 3.05.
1. Pull and hold flat receiving surface in area to be patched.
 2. Seal each patch by extrusion welding continuous bead along edge, with no free edge remaining. Vacuum box test each patch on completion.

3.08 FIELD QUALITY CONTROL

A. Conformance Testing:

1. Prior to deployment of the geosynthetics, the Subcontractor shall collect samples and perform conformance testing to document conformance to the properties listed in Table 1. The Subcontractor shall submit test results to the Subcontract Technical Representative (STR). The Subcontractor shall submit them to a qualified laboratory of their choice for testing. Samples shall be collected at the project site. Unless otherwise specified, samples shall be taken at a rate of one per lot or one per 100,000 square feet, whichever results in the greater number of tests.
2. Samples shall be taken from any portion of the roll that has not been damaged. Unless otherwise specified, samples shall be 2 feet long by the roll width. Samples may be cut to a minimum size of 2 feet by 1 foot. The pieces of a sample shall be labeled in a manner to correctly identify the location of the piece within the sample. Machine direction shall be marked on each sample piece with an arrow.
3. Collection of the sample shall be performed under the observation of the Subcontract Technical Representative (STR) or designated representative.

B. Nondestructive Field Testing: Nondestructively test all field seams over their full length using an air pressure test or other approved methods. Only use a vacuum box when air pressure testing cannot be performed. Nondestructive testing shall be carried out as the seaming progresses and not at completion of all seaming. Results shall be provided in writing to the Subcontract Technical Representative (STR) by the end of each testing day.

1. Vacuum testing shall conform to the following requirements:
 - a. Equipment shall consist of two vacuum box assemblies consisting of a rigid housing, a transparent viewing window, a soft neoprene gasket attached to the bottom, a port hole or valve assembly, a vacuum gauge, a vacuum pump assembly equipped with a pressure control, a rubber pressure/vacuum hose with fittings and connections, a soapy solution and an applicator.

- b. Testing shall conform to the following procedure. Brush soapy solution on geomembrane (approximately 12-inch by 36-inch). Place vacuum box over the wetted seam area. Close bleed valve and open vacuum valve and ensure that a leak-tight seal is created. Apply a vacuum of approximately 5 psi. Examine the geomembrane through the viewing window for the presence of soap bubbles for not less than 15 seconds. All areas where soap bubbles appear shall be marked and repaired as described in this section. If no bubbles appear after 15 seconds, then close vacuum valve and open bleed valve, move box over to the next adjoining area with minimum 3 inches overlap, and repeat process.

2. Air Pressure Testing:

- a. Equipment shall consist of an air pump (manual or motor driven) equipped with a pressure gauge capable of generating and sustaining pressure over 30 psi and mounted on a cushion to protect the geomembrane, a rubber hose with fittings and connections, a sharp hollow needle, or other approved pressure feed device, and a gauge with an accuracy of 1 psi.
- b. Testing shall conform GRI GM6 and the following procedure: Seal both ends of the seam to be tested. Insert needle or other approved pressure-feed device into the channel created by the double-wedge weld. Energize the air pump to a minimum pressure of 30 psi, close the valve, and sustain the pressure for at least 5 minutes. If pressure loss exceeds 4 psi or does not stabilize, locate faulty area and repair as described in this section. Puncture opposite end of the seam to release air. If blockage is present, locate and test seam on both sides of blockage. Remove needle or other approved pressure-feed device and seal penetration holes by extrusion welding.

3. Destructive Field Test Sampling:

- a. The Subcontractor shall collect destructive test samples at a minimum frequency of one test per 500 feet of seam length for geomembrane and engineered turf components. The Contractor's Engineer reserves the right to adjust this testing requirement if other seam tests appear adequate for assuring seam quality. Test locations shall be determined during seaming. Locations may be prompted by appearance of excess heating, contamination, offset welds, or suspected defect. The Contractor's Engineer may choose the locations. The Contractor's Engineer will not notify the Subcontractor in advance of selecting locations where seam samples will be taken.

- b. The Subcontractor shall cut samples at locations designated by the Contractor's Engineer as the seaming progresses, in order to obtain laboratory test results before the geomembrane is covered. The Subcontractor shall number each sample and mark the sample number and location on the panel layout drawing.
- c. The Subcontractor shall immediately repair all holes in the geosynthetics resulting from destructive sampling. The continuity of the repair shall be vacuum tested in accordance with this section.
- d. The destruction sample shall be 18 inches wide by 36 inches long with the seam centered lengthwise. The sample shall be cut into three equal parts for distribution to the Subcontractor for field-testing, the Geomembrane Testing Laboratory for analytical testing, and the Contractor for archiving. The Subcontractor shall test the piece that he retains for peel and shear in the field in accordance with Table 2 using a digital tensiometer. This shall be performed under the observation of the Contractor's Engineer or designated representative. The results of the field tests shall be provided in writing by Subcontractor to the Subcontract Technical Representative (STR) within 24 hours of testing.

C. Destructive Test Sample Testing:

- 1. The Subcontractor will submit the destructive test samples for laboratory testing. The Subcontractor will select and retain the geomembrane testing laboratory.
- 2. Samples shall be tested in peel and shear (ASTM 6392). Minimum acceptable stress to be obtained for these tests shall be as listed in Table 2.
- 3. All tests shall exhibit a Film Tearing Bond type of separation in which the geomembrane material tears before the weld.
- 4. At least five coupons shall be tested by each test method.
- 5. Four of the five coupons shall meet the minimum requirements stated herein.
- 6. The Subcontractor shall submit test results to the Subcontract Technical Representative (STR) within 48 hours of receipt of the samples by the geomembrane testing laboratory.

D. Destructive Test Failure:

- 1. One of two options shall be followed:

- a. Option 1: Reconstruct the seam between any two passed test locations.
 - b. Option 2: Trace the weld to an intermediate location at least 10 feet minimum or to where the seam ends, in both directions from the location of the failed test. Check the next seam welded using the same welding device if required to obtain additional sample (such as, if one side of the seam is less than 10 feet long). Bounding laboratory samples shall be taken, and destructive testing shall be performed per this section. If the bounding samples pass, then the seam shall be reconstructed between the test sample locations. If any additional samples fail, then the process shall be repeated to establish the zone in which the seam shall be reconstructed.
2. Reconstruction methods shall include cap stripping of seam, or replacing seam with a new 1-foot wide panel and welding in place.
- E. Acceptable seams shall be bounded by two locations from which samples have passed destructive tests. For reconstructed seams exceeding 50 feet, a sample taken from within the reconstructed seam shall also pass destructive testing. Whenever a sample fails, additional testing may be required for seams that were welded by the same welder and welding apparatus or were welded during the same shift.

3.09 CLEANUP

- A. Clean up the work area as the installation work proceeds. Take particular care to ensure that no trash, tools, and other unwanted materials are trapped beneath geomembrane and that scraps of geosynthetic material are removed from the work area prior to completion of installation.

3.10 SUPPLEMENT

- A. The supplement listed below, following “End of Section,” is a part of this specification.
 - 1. Geomembrane Installer’s Certification of Subsurface Acceptability.

END OF SECTION

**GEOMEMBRANE INSTALLER'S CERTIFICATION
OF
SUBSURFACE ACCEPTABILITY**

Geomembrane installer, _____

for On-site Waste Disposal Facility Groundwater Field Demonstration hereby certifies that supporting surfaces are acceptable for installation of geomembrane, undersigned having personally inspected condition of constructed and prepared surfaces. This certification is for areas defined as follows:

Condition of supporting surfaces in defined area meets or exceeds minimum requirements for installation of geomembrane.

Signed: _____
(Representative of Geomembrane Installer)

(Position)

Date: _____

Witness: _____

SEDIMENT POND CALCULATION

This page intentionally left blank.

Calculation No.:	CAC-OSWDF-I361	Revision No.:	B
Calculation Title:	OSWDF Storm Water Modeling		
Project Number:	700497	Quality Level:	QL-2
Client:	United Cleanup Oak Ridge LLC (UCOR)		
Engineering Discipline:	Civil		
Supersedes:	Revision A		
Unverified Assumptions:	Y <input type="checkbox"/> N <input checked="" type="checkbox"/>		
Software Used:	Y <input checked="" type="checkbox"/> N <input type="checkbox"/>		
Revision History:			
Revision No.	Revision Description	Date	Affected Pages
A	Initial Issue for Review	03/20/23	All
B	GWFD Sediment Basins Only	08/28/23	All

Document Review & Approval:

Prepared By:	Jim Defenderfer	Date	08/28/23
Checked By:	Ron Miller	Date	08/28/23
Approved By:	David Matlock	Date	08/28/23

Table of Contents

1.	Objective.....	4
2.	Introduction.....	4
3.	Parameters and Criteria	4
3.1	Regulatory Requirements.....	4
3.2	Hydrologic Parameters.....	4
3.2.1	Precipitation Data.....	4
4.	Methodology	5
4.1	GWFD Sediment Basin Design and Simulation.....	5
5.	Conclusions/Recommendations.....	12
6.	References.....	12
7.	Computer Software	12
	Appendix A Figure – Proposed (GWFD) Conditions	13
	Appendix B Model Results – Proposed (GWFD) Conditions.....	15
	Appendix C TDEC Sediment Basin Evaluation – Proposed GWFD Conditions	17

Acronyms

ac	acres
ac-ft	acre-feet
BCR	Bear Creek Road
CERCLA	Comprehensive Environmental Response, Compensation, and Liability Act
ESP	Early Site Preparation
ft/s	feet per second
ft ³ /s	cubic feet per second
ft ²	square feet
ft ³	cubic feet
ft msl	feet mean sea level
GWFD	Groundwater Field Demonstration
in	inch or inches
NOAA	National Oceanic and Atmospheric Administration
NPDES	National Pollutant Discharge Elimination System
NWS	National Weather Service
OSWDF	On-Site Waste Disposal Facility
SCS	Soil Conservation Service
Tc	time of concentration
TDEC	Tennessee Department of Conservation
USDA	United States Department of Agriculture
USDOC	United States Department of Commerce
yd ³	cubic yard
yrs	years

1. Objective

The On-Site Waste Disposal Facility (OSWDF) has been proposed to facilitate disposal of additional waste being generated under Comprehensive Environmental Response, Compensation, and Liability Act (CERCLA) actions at the Oak Ridge Reservation. Successful completion of the OSWDF will require effective management of storm water through various phases of construction, including Early Site Preparation (ESP) and the Groundwater Field Demonstration (GWFD). This document describes design and modeling of two sediment basins to be constructed in support of the GWFD and is an excerpt from a larger, more comprehensive calculation addressing storm water management at the site.

2. Introduction

Early Site Preparation projects planned in support of the OSWDF include rerouting of the Haul Road and Bear Creek Road to clear the footprint of the new landfill facility. Road relocation will require construction of roadside ditches and installation of new culverts to facilitate drainage beneath the roadways. Following this initial phase of construction, drainage through the site will be significantly altered during construction of the GWFD and the OSWDF.

Implementation of the GWFD will require site clearing and grading, disturbing approximately 25 acres of the 45-acre OSWDF Site. Treatment of sediment-laden storm water runoff from the GWFD through sediment basins will be necessary when clearing and stripping of the area commences. Storm water management for the GWFD will also include a stormflow interceptor trench north of the knoll, diversion of the D-10W drainage, installation of ditches to facilitate cover drainage, culvert installation, and erosion control.

A representative model of the GWFD Site condition was developed in Bentley Systems, Inc. OpenFlows CivilStorm® (CivilStorm®) to simulate runoff conditions from the site to size and evaluate the performance of sediment basins in compliance with Tennessee Department of Environment and Conservation (TDEC) regulations. The model represents the GWFD Site following initial clearing with the GWFD footprint in a bare-soil condition. As the model was developed as part of a comprehensive storm water analysis, the model domain includes areas beyond the GWFD footprint and generally extends north from Bear Creek Road to the top of Pine Ridge, and to the drainage boundaries to local tributaries NT-11 to the west, and NT-9 to the east (Figure A-1). Additional discussion of model development and the hydrologic and hydraulic parameters and definitions used in the model is provided in the parent calculation to this excerpt.

3. Parameters and Criteria

3.1 Regulatory Requirements

For sediment basin design, the GWFD project follows the design criteria set forth in the TDEC Erosion and Sediment Control Handbook (TDEC 2012) and are discussed further in Section 4 and Appendix C.

3.2 Hydrologic Parameters

3.2.1 Precipitation Data

Point precipitation frequency data for the basin analysis is from the National Oceanic and Atmospheric Administration (NOAA) Atlas 14, Volume 2, Version 3 (USDOC 2006). The estimated 24-hour storm event precipitation depths for Oak Ridge, TN for 2, 5, and 25-year recurrence intervals are provided in Table 1.

Recurrence Interval (yrs)	Precipitation Depth Estimate (in)
2	3.33
5	4.06
25	5.46

Table 1. Estimated 24-hour Storm Event Precipitation Depths for the OSWDF Site, Oak Ridge, Tennessee (USDOC 2006).

The precipitation depth for the 2-year storm event was used for time of concentration calculations only and was not otherwise used for design purposes.

The National Weather Service (NWS) is currently evaluating the possible effects of non-stationary climate on depth-duration-frequency precipitation magnitudes from NOAA Atlas 14. This evaluation may result in an upward revision of precipitation depths and intensities, or a reclassification of current precipitation depths to shorter recurrence intervals. Currently, the NWS plans to release updated precipitation frequency estimates for the continental United States as NOAA Atlas 15 Volumes 1 and 2 during calendar years 2026 and 2027. Volume 1 will account for temporal trends in historical observations, and Volume 2 will use future climate model projections to generate adjustment factors for Volume 1. The revised estimates may or may not vary significantly from the current Atlas 14 precipitation frequency estimates for the OSWDF Site. However, as a conservative approach, the precipitation depths in the Proposed GWFD Conditions model used to evaluate the basin and outlet structure configurations were increased by 15% beyond those provided in NOAA Atlas 14 for the 5-year and 25-year, 24-hour design storms.

4. Methodology

The CivilStorm® storm water system analysis and design software was used for the site condition model simulations. The simulations used the SCS runoff method presented in Technical Paper 129 (USDA 1973) and peak discharge determinations from USDA Technical Release 55 (USDA 1986). Composite time of concentration (Tc) were calculated in CivilStorm® based on individual inputs for sheet flow, shallow concentrated flow, and ditch flow using the method described in TR-55 (USDA 1986). A minimum Tc value of 0.10 hours was used per guidance from TR-55 (USDA 1986). CivilStorm® requires water storage areas to be predefined and thus areas referred to as “ponds” herein may represent a sediment basin, a natural depression, or a headwater storage area for culverts.

4.1 GWFD Sediment Basin Design and Simulation

The Proposed Conditions Model with runoff curve numbers and sheet flow roughness coefficients for a bare-soil GWFD footprint condition was used for design and performance evaluation of the sediment basins. Approximately 7.8 acres of the GWFD footprint drains to the Southeast Sediment Basin (Pond 2), and 20.8 acres drains to the Southwest Sediment Basin (Pond 1). The basins were simulated as ponds receiving inflow from disturbed areas, routed to the basins through either a constructed channel or culvert discharging into the basin's forebay. The basin's principal spillways (riser inlet box and drainpipe barrel), skimmers, and emergency spillways were also incorporated, with the emergency spillways simulated as trapezoidal weirs in the model.

The design storms used to evaluate the sediment basin performance were the 5-year, 24-hour storm and the 25-year, 24-hour storm events using point precipitation frequency estimates for Oak Ridge, TN (USDOC 2006). The 2-year, 24-hour storm depth is incorporated in the time of concentration calculation for sheet flow but was not otherwise used for sediment basin simulations. The drainage outfalls for the basins ultimately flow into receiving waters listed as impaired and, therefore, the design storm used for sizing the area of the basins and evaluating the principal spillways is the 5-year, 24-hour storm event per TDEC requirements.

Table 2 presents the design characteristics used as inputs for the Southeast and Southwest Sediment Basins in the CivilStorm® simulation:

Southeast Sediment Basin (Pond 2) Configuration:

Drainage Area (acres)	7.8
Basin Bottom Elevation (ft msl)	887.5
Basin Crest Elevation (ft msl)	895.5
Riprap Berm Notch Top Elevation (ft msl)	892.5
Riprap Berm Side Slope (ft/ft)	3:1
Wet Storage Top Elevation (ft msl)	890.5
Wet Storage Volume (ft ³)	21,189
Dry Storage Top Elevation (ft msl)	892.5
Dry Storage Volume (ft ³)	29,627
Total Storage at Emergency Spillway (ft ³)	73,898

Southeast Sediment Basin (Pond 2) Outlet Structure Configuration:

Principal Spillway Riser Inlet Box Top Elevation (ft msl)	892.5
Principal Spillway Riser Inlet Box Side Length (ft)	3
Principal Spillway Drainpipe Barrel Diameter (in)	24
Principal Spillway Drainpipe Barrel Inlet Invert (ft msl)	885.00
Principal Spillway Drainpipe Barrel Outlet Invert (ft msl)	884.00
Principal Spillway Drainpipe Barrel Length (ft)	77.0 (1.29% slope)
Principal Spillway Skimmer Inlet Diameter (in)	4" (2.8" orifice)
Skimmer Active Range (ft msl)	890.5 – 895.5
Emergency Spillway Elevation (ft msl)	894.0

Southwest Sediment Basin (Pond 1) Configuration:

Drainage Area (acres)	20.8
Basin Bottom Elevation (ft msl)	870.0
Basin Crest Elevation (ft msl)	878.0
Riprap Berm Notch Top Elevation (ft msl)	875.0
Riprap Berm Side Slope (ft/ft)	3:1
Wet Storage Top Elevation (ft msl)	873.0
Wet Storage Volume (ft ³)	69,650
Dry Storage Top Elevation (ft msl)	875.0
Dry Storage Volume (ft ³)	79,681
Total Storage at Emergency Spillway (ft ³)	302,206

Southwest Sediment Basin (Pond 1) Outlet Structure Configuration:

Principal Spillway Riser Inlet Box Top Elevation (ft msl)	875.0
Principal Spillway Riser Inlet Box Side Length (ft)	4
Principal Spillway Drainpipe Barrel Diameter (in)	36.0
Principal Spillway Drainpipe Barrel Inlet Invert (ft msl)	866.52
Principal Spillway Drainpipe Barrel Outlet Invert (ft msl)	865.80
Principal Spillway Drainpipe Barrel Length (ft)	72.0 (1.0% slope)
Principal Spillway Skimmer Inlet Diameter (in)	5 (4.5" orifice)
Skimmer Active Range (ft msl)	873.0 – 878.0
Emergency Spillway Elevation (ft msl)	876.5

Table 2. Southeast and Southwest Sediment Basin and Outlet Structure Configurations.

Skimmers were sized based on vendor information available on the Faircloth Skimmer website (<https://www.fairclothskimmer.com/>). The site provides an interface to determine the proper skimmer/orifice size based on the dewatering volume/time requirement. Figure 1 shows the skimmer/orifice combinations required to dewater the dry storage volumes of the Southeast and Southwest Basins (29,627 and 79,681 ft³, respectively) in 72 hours (Figures C-1 and C-2).

Southeast Basin (Pond 2):

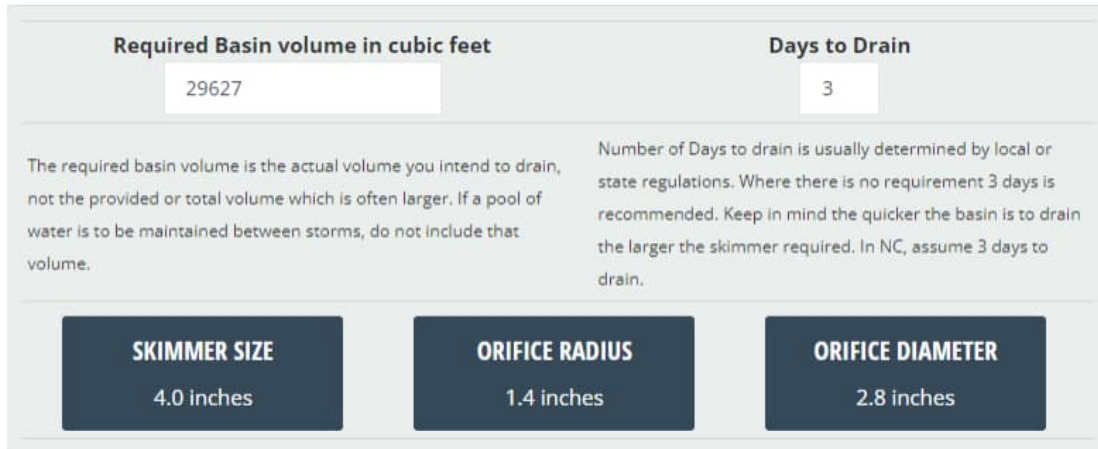

Southwest Basin (Pond 1):

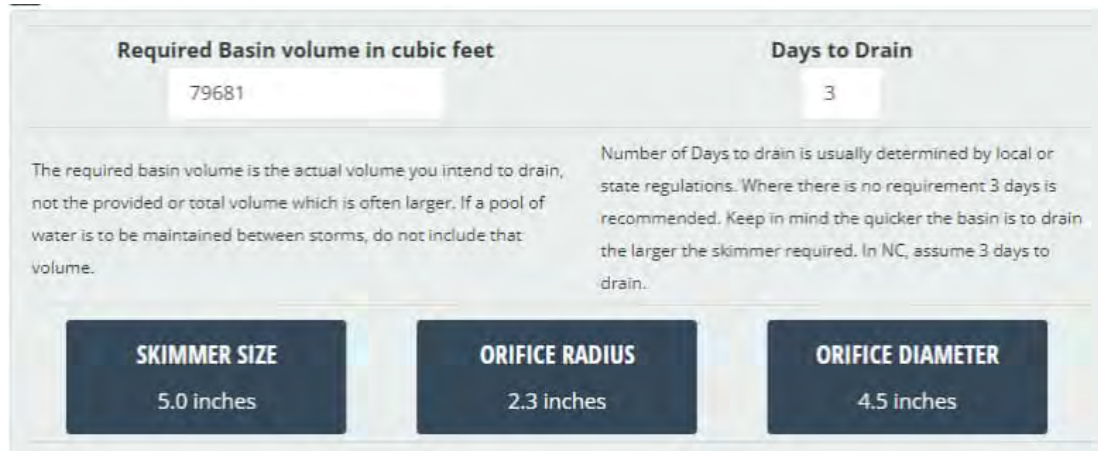
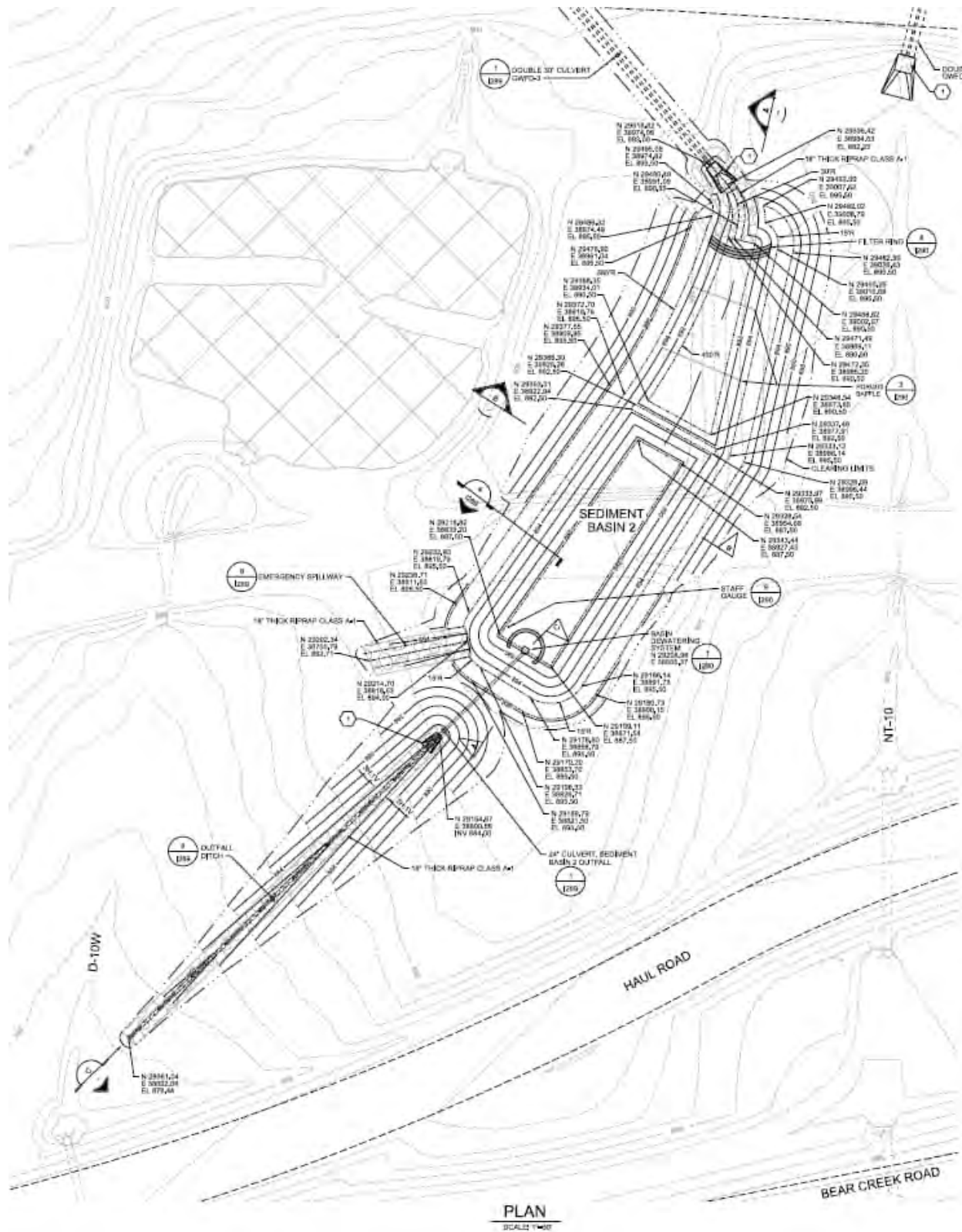
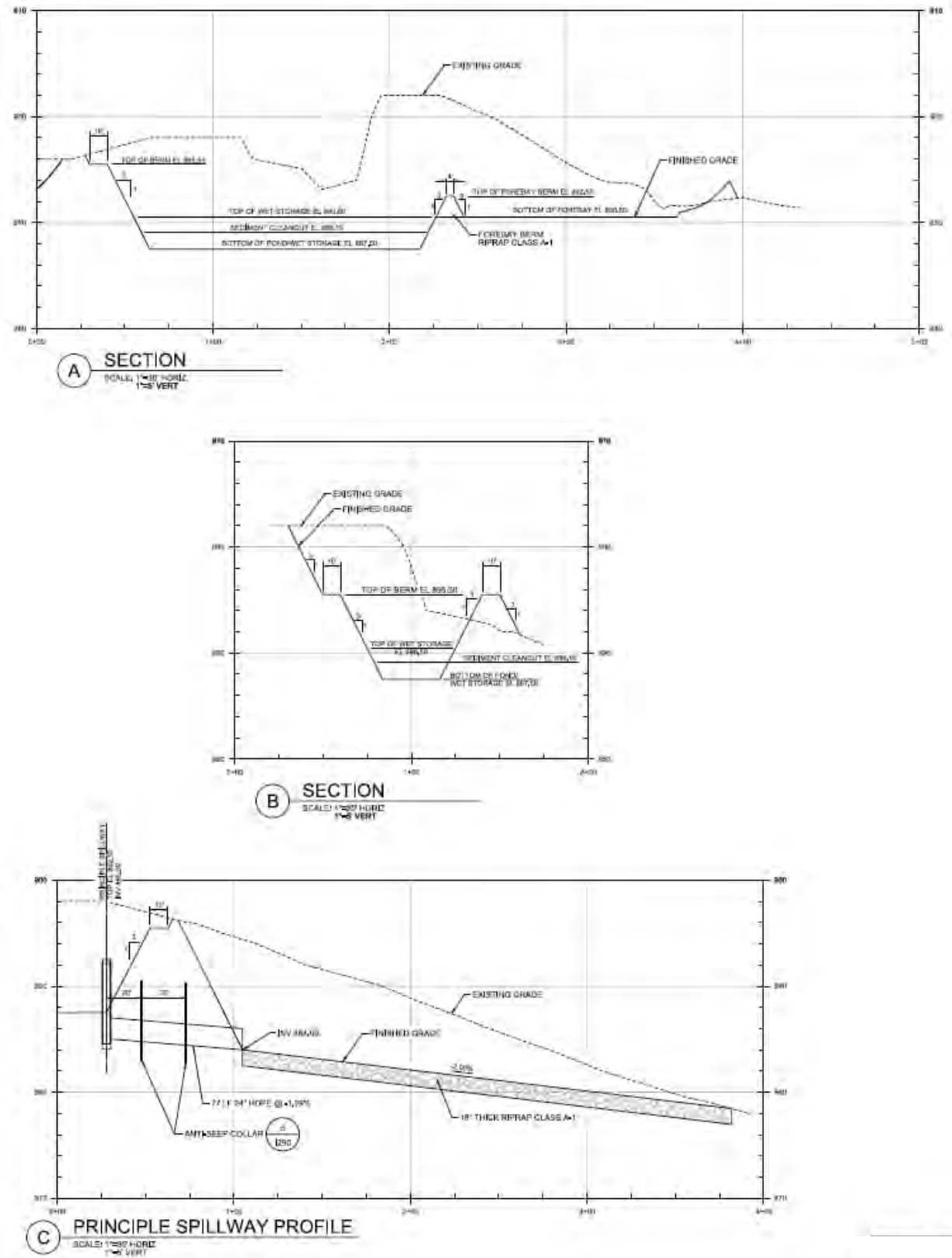

Figure 1. Faircloth Skimmer Sizing Results for Sediment Basins (Ponds 1 and 2).

Figures 2 and 3 depict the Southeast and Southwest Sediment Basins and their outlet structures as represented in the design drawings (Jacobs 2020-2023):





From Drawing C2E-OSWDF-I286 (Jacobs 2023).

Figure 2. Plan and Sections of Southeast Sediment Basin (Pond 2).

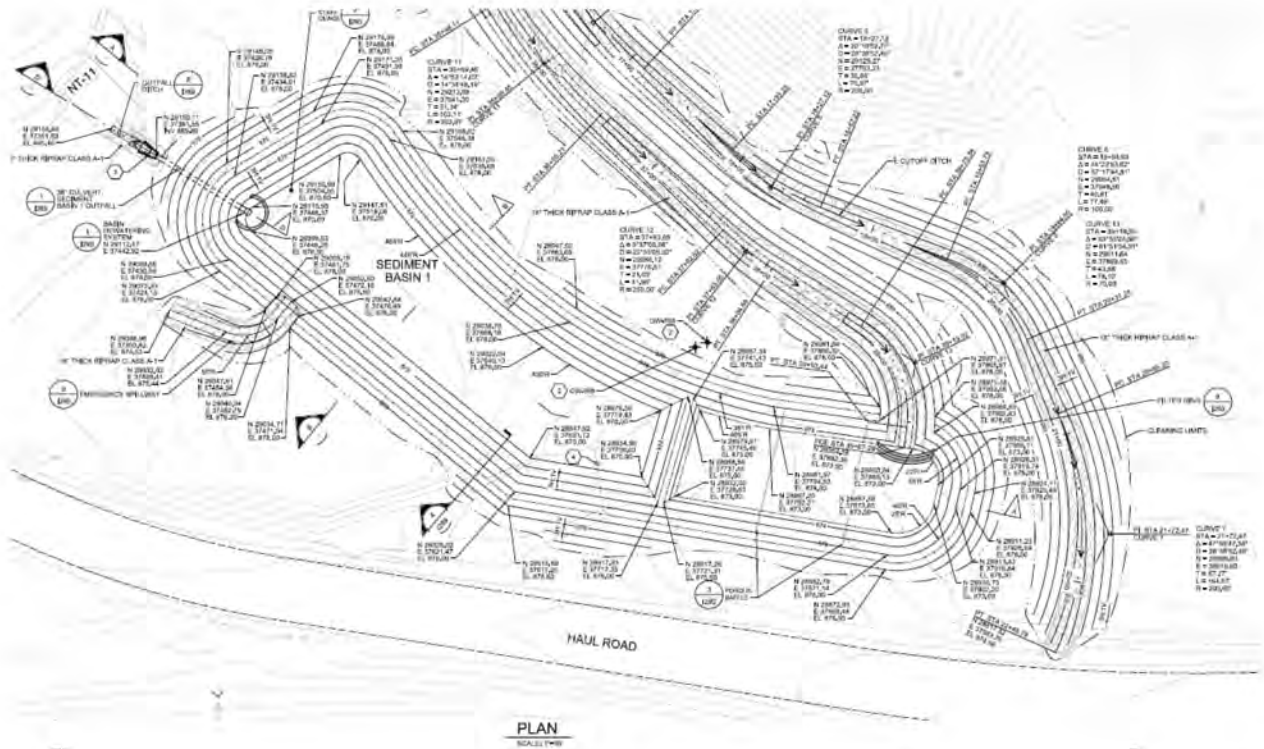

PLAN
SCALE: 1"=30'

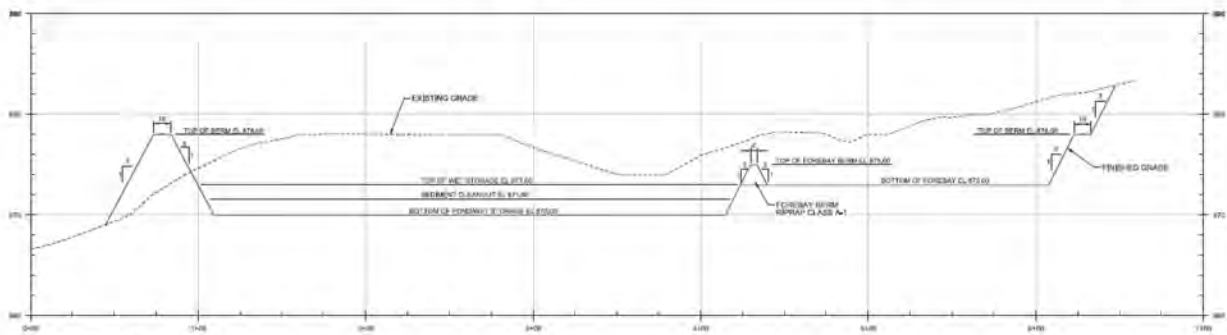

A SECTION
SCALE: 1"=30' HORIZ
1"=5' VERT

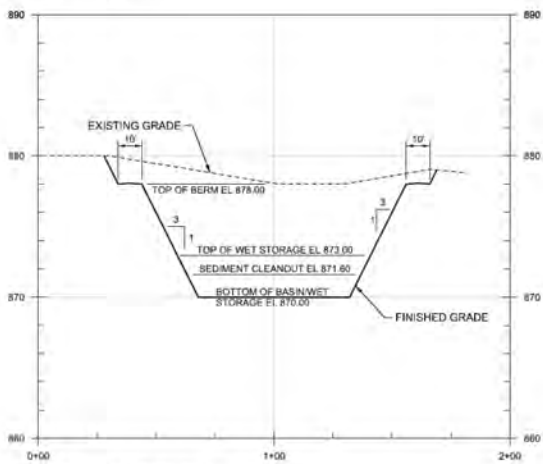

B SECTION
SCALE: 1"=30' HORIZ
1"=5' VERT

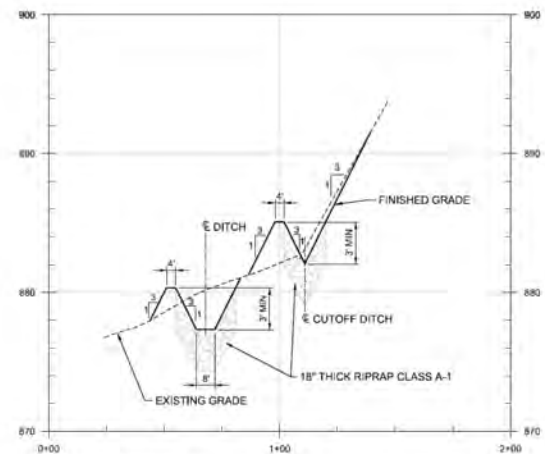

C SECTION
SCALE: 1"=30' HORIZ
1"=5' VERT

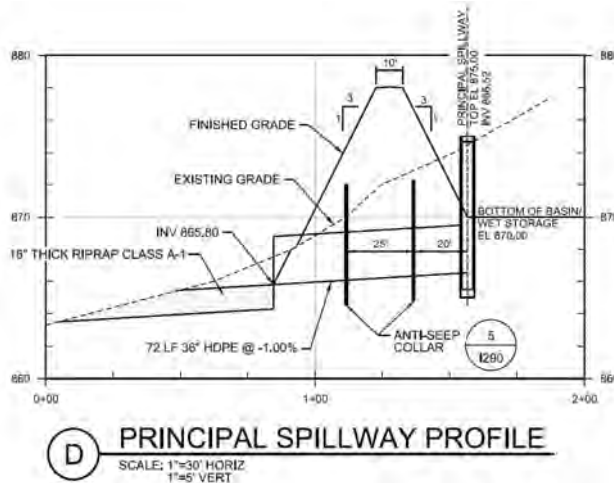

From Drawing C2E-OSWDF-I285 (Jacobs 2023).

Figure 3. Plan and Section of Southwest Sediment Basin (Pond 1).

Model results for the basins were evaluated against the TDEC performance requirements. The principal spillways and dewatering devices must accommodate the peak runoff flow from the 5-year, 24-hour storm with no discharge passing through their respective emergency spillways. In addition, the basins must be designed such that the principal spillways and emergency spillways pass the peak runoff from the 25-year, 24-hour storm (TDEC 2012). Table 3 provides a comparison of the model-predicted basin water levels for the 5 and 25-year, 24-hour storm events to the elevation of the principal and emergency spillways. The basin water level elevations indicate that the principal spillway is sufficient to convey inflow from the 5-year, 24-hour storm, and the combined principal and emergency spillways convey the inflow from the 25-year, 24-hour storm.

Proposed Conditions

Bear Creek Modified Culvert and Ditch Configurations, GWFD Bare Soil, Sediment Basin Design

Sediment Basin	Top of Principal Spillway (ft msl)	Emergency Spillway Elevation (ft msl)	5-year, 24-hour Storm Event Maximum Water Level (ft msl)	25-year, 24-hour Storm Event Maximum Water Level (ft msl)
Southwest Basin (Pond 1)	875.00	876.50	875.94	876.88
Southeast Basin (Pond 2)	892.50	894.00	893.57	894.34

Table 3. Southwest (Pond 1) and Southeast (Pond 2) Sediment Basin Spillway Elevations and Model-Predicted Maximum Water Levels for the 5 and 25-year Storm Events.

Additional sediment basin simulation output is included in Appendix B, Table B-1, and Figures B-1 and B-2. A detailed summary of the TDEC design criteria for sediment basins is provided in Appendix C. Each criterion is followed by a discussion of the model-predicted basin performance or design characteristics that verify compliance with TDEC requirements.

5. Conclusions/Recommendations

The sediment basins proposed to treat sediment-laden runoff from the GWFD are appropriately designed to manage the flow from the 5-year and 25-year, 24-hour Design Storms. Based on the results of the CivilStorm® modeling, the proposed designs presented for the Southeast and Southwest Sediment Basins meet these and other TDEC configuration and performance requirements (TDEC 2012).

6. References

Jacobs Engineering Group Inc. (Jacobs). 2020. *Design Drawings for the Haul Road and Bear Creek Road Relocations for the Early Site Preparation for the On-Site Waste Disposal Facility*.

Jacobs. 2020-2023. *Preliminary Design Drawings for the Groundwater Field Demonstration for the On-Site Waste Disposal Facility*.

Tennessee Department of Environment and Conservation (TDEC). 2012. *Erosion and Sediment Control Handbook, Fourth Edition*.

United States Department of Agriculture (USDA). 1973. *A Method for Estimating Volume and Rate of Runoff in Small Watersheds*. Technical Paper 129 (SCS-TP-149).

USDA. 1986. *Urban Hydrology for Small Watersheds*. Technical Release 55 (SCS-TR-55).

United States Department of Commerce (USDOC). 2006. *NOAA Atlas 14 Precipitation Frequency Atlas of the United States, Volume 2 Version 3*.

7. Computer Software

Simulations of storm water runoff, ditch and culvert flow, and sediment basin performance were completed using Bentley Systems, Inc. OpenFlows CivilStorm® CONNECT Edition Update 3, Version 10.03.00.77, verification and validation date 06/01/23.

Appendix A
Figure – Proposed (GWFD) Conditions

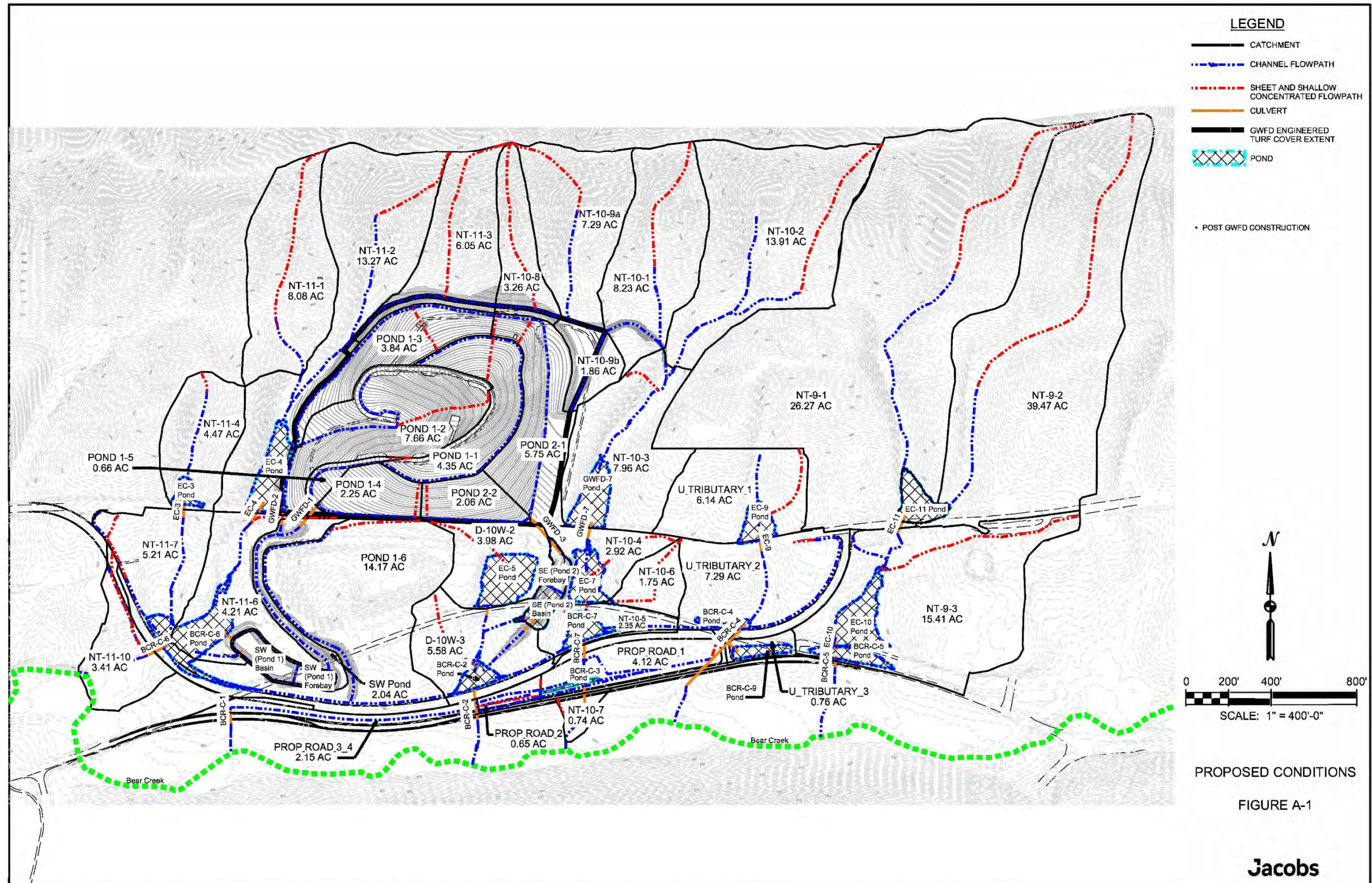

FILENAME: I:\UCOR\700451 - GWFD completion (for OSWDF)\ENGIC_Civil\Calculation\Figures\Proposed Conditions

PLOT DATE: 07/25/2023

PLOT TIME: 10:00 AM

Figure A-1. Proposed (GWFD) Conditions.

Appendix B Model Results – Proposed (GWFD) Conditions

Watershed Area	Storm Event	Peak Inflow - Basin (ft ³ /s)	Volume (ac-ft)	Max Water Elev (ft msl)	Peak Outflow - Prin. Spillway (ft ³ /s)	Peak Outflow - Skimmer (ft ³ /s)	Peak Outflow - Emer. Spillway (ft ³ /s)
Southeast Basin	5yr, 24hr Storm	39.90	2.381	893.57	25.12	0.11	0
	25yr, 24hr Storm		3.402	894.34	33.14	N/A	6.28
Southwest Basin	5yr, 24hr Storm	86.82	5.542	875.94	44.69	0.31	0
	25yr, 24hr Storm		7.960	876.88	59.49	N/A	7.57

Table B-1. Model Results Summary for the Southeast and Southwest Sediment Basins.

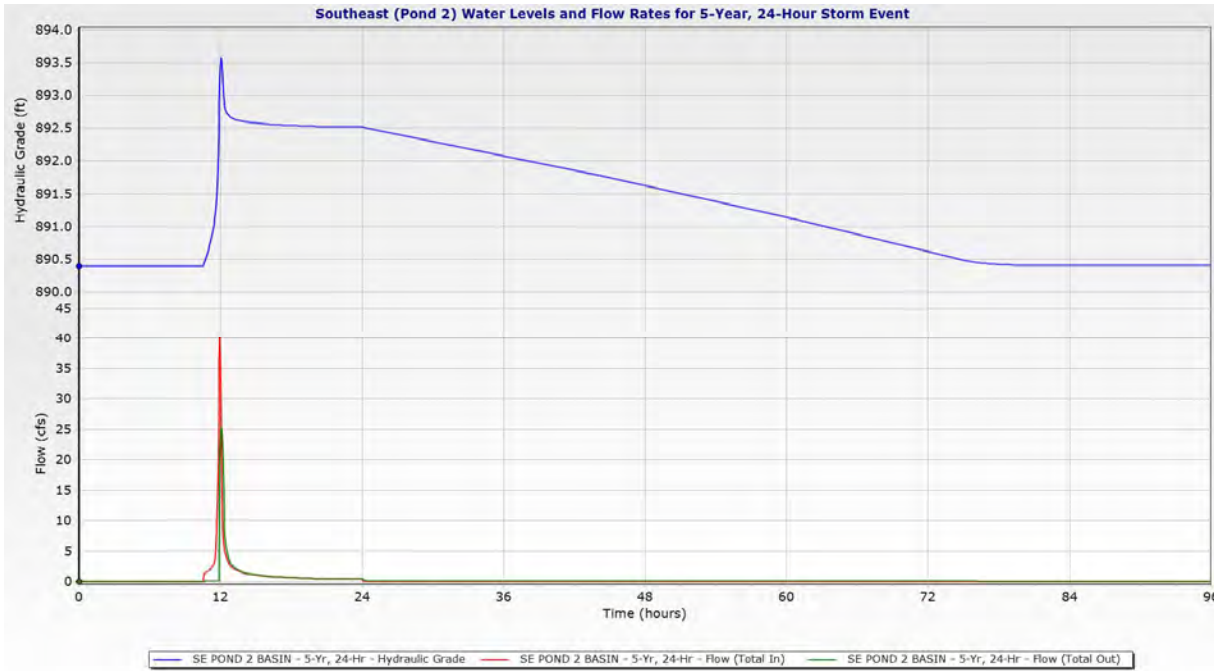

Figure B-1. Southeast (Pond 2) Water Levels and Flow Rates for the 5-year, 24-hour Storm Event.

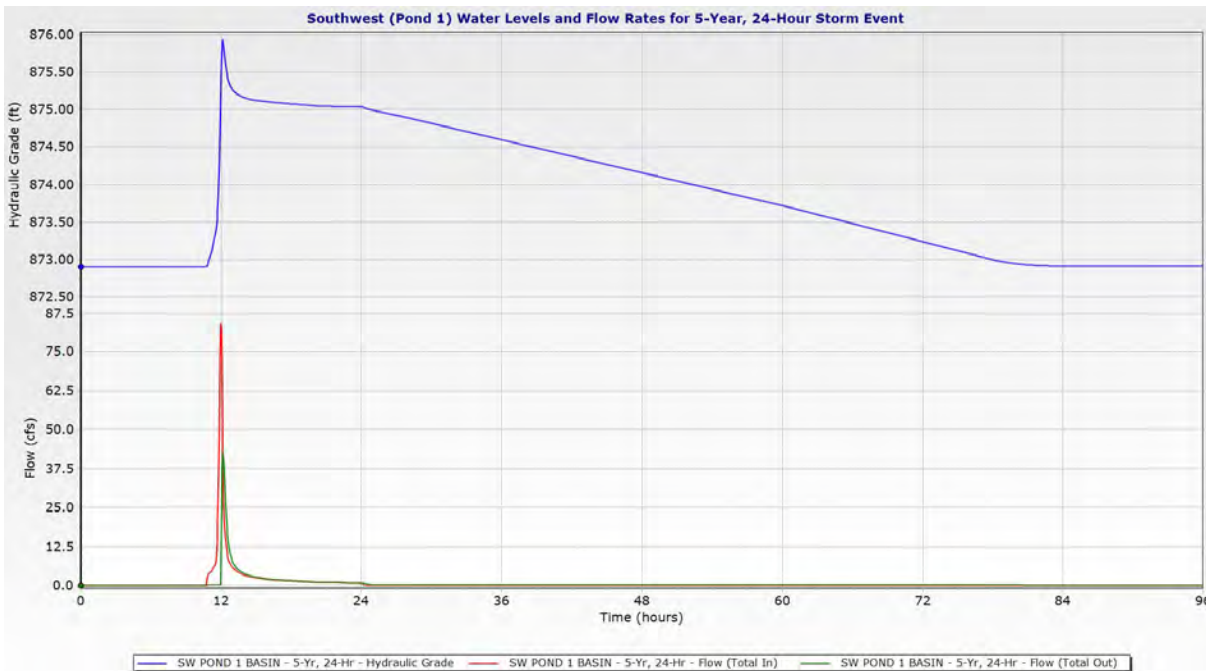

Figure B-2. Southwest (Pond 1) Water Levels and Flow Rates for the 5-year, 24-hour Storm Event.

Appendix C
TDEC Sediment Basin Evaluation –
Proposed GWFD Conditions

C.1 Introduction

The Southeast and Southwest Sediment Basins are to be developed in support of the Groundwater Field Demonstration portion of the Early Site Preparation Project. The sediment basins have been designed and modeled to ensure compliance with the criteria specified in the Tennessee Department of Environment and Conservation (TDEC) Erosion & Sediment Control Handbook (TDEC 2012).

C.2 Sediment Basin and Principal Spillway Analysis with TDEC Requirements

The following provides a comparison of the proposed basins/structures with the TDEC-suggested design criteria for a newly-designed sediment basin. CivilStorm® model simulations of the drainage areas, basin and outlet structures have been developed to support the design and ensure compliance with TDEC design criteria.

The drainage outfalls from the basins ultimately flow into Bear Creek, which is listed as an impaired receiving water. Therefore, the site must be protected at a higher level, including the elevated design criteria for the sediment basin. The following analysis lists each relevant design criterion followed by an analysis of the proposed sediment basin and principal spillway design characteristics and/or predicted performance against the criterion. The TDEC design criteria are found in Chapter 7.31 of the Management Practices in the Erosion & Sediment Control Handbook for Sediment Basins (TDEC 2012).

Design Criterion 1

For an on-site outfall draining to impaired waters with a total drainage area of 5 or more acres, a minimum temporary (or permanent) sediment basin volume shall be provided until final stabilization of the site that will provide treatment for a calculated volume of runoff from a 5-year, 24-hour storm and runoff from each acre drained, or equivalent control measures.

Discussion

The sediment basins are providing “treatment” of the storm water through controlled detention and discharge through the outlet structure. (Note: the “treatment” requirement, although not included on page 21 of Section 2.1.1 of the handbook, is clarified on page 80 of the handbook as well as page 31 of the State of Tennessee NPDES Permit section of the handbook).

The Southeast Sediment Basin drainage area (7.8 acres) and the Southwest Sediment Basin drainage area (20.8 acres) both exceed 5 acres.

The runoff volume from the 5-year, 24-hour storm to the Southeast Sediment Basin is 2.382 ac-ft (3,843 cy). The Southeast Sediment Basin volume below the principal spillway is 1,882 cy (wet storage and dry storage). The Southeast Sediment Basin volume below the emergency spillway is 2,737 cy (includes dry storage). The CivilStorm® modeling of the 5-year, 24-hour storm runoff and flow through the Southeast Sediment Basin indicates the basin provides controlled detention and discharge of the runoff volume, with a maximum water level in basin of 893.57 ft msl, which is 0.43 ft below the emergency spillway elevation.

The runoff volume from the 5-year, 24-hour storm to the Southwest Sediment Basin is 4.879 ac-ft (7,871 cy). The Southwest Sediment Basin volume below the principal spillway is 5,712 cy (wet storage and dry storage). The Southwest Sediment Basin volume below the emergency spillway is 8,118 cy (includes dry storage). The CivilStorm® modeling of the 5-year, 24-hour storm runoff and flow through the Southwest Sediment Basin indicates the basin provides controlled detention and discharge of the runoff volume, with a maximum water level in basin of 875.94 ft msl, which is 0.56 ft below the emergency spillway elevation.

- Sediment basins meet the criterion.

Design Criterion 2

Access to maintain the basin must be provided during basin construction and operation.

Discussion

The design will allow access to the basins, with interior side slopes of 3:1.

- Sediment basins meet the criterion.

Design Criterion 3

The basin shape shall have a minimum length to width ratio of 4L to 1W. Alternatives to this requirement include a wedge-shaped pond as well as the addition of baffles.

Discussion

The length to width ratio is calculated by the following formula: $L:W = L/We = L/(A/L) = L^2/A$

where;

We =effective width

L = length of flow path (distance from the point of inflow to the riser outflow point), and

A = area of active pool (surface area at principal spillway riser invert elevation)

The flowpath length of the Southeast Sediment Basin is 352 feet. The area of the basin at the principal spillway elevation is 17,695 ft². Therefore, the length to width ratio of the basin is:

$$L:W = (352 \text{ ft})^2 / 17,695 \text{ ft}^2 = 6.98 \text{ to } 1$$

The flowpath length of the Southwest Sediment Basin is 491 feet. The area of the basin at the principal spillway elevation is 43,987 ft². Therefore, the length to width ratio of the basin is:

$$L:W = (491 \text{ ft})^2 / 43,987 \text{ ft}^2 = 5.49 \text{ to } 1$$

- Sediment basins meet the criterion.

Design Criterion 4

Sediment basin volume shall be 134 cy/acre (3,618 cf/acre) of drainage.

Discussion

The Southeast areal drainage extent is 7.8 acres, which results in a required basin volume beneath the principal spillway crest elevation of 1,045.2 cy (28,220 cf). The total Southeast Sediment Basin volume below the principal spillway crest is 1,882 cy (50,814 cf), which exceeds the criterion.

The Southwest areal drainage extent is 20.8 acres, which results in a required basin volume beneath the principal spillway crest elevation of 2,787.2 cy (75,254 cf). The total Southwest Sediment Basin volume below the principal spillway crest is 5,531 cy (149,337 cf), which exceeds the criterion.

- Sediment basins meet the criterion.

Design Criterion 5

Half of sediment basin volume shall be wet storage = 67 cy/acre (1,809 cf/acre).

Discussion

The required wet storage volume for the Southeast Basin is 7.8 acres x 67 cy/acre = 522.6 cy. The wet storage volume is measured from the lowest point of the basin up to the bottom operating range of the dewatering device. The design wet storage volume for the basin is approximately 784.8 cy, which exceeds the minimum requirement.

The required wet storage volume for the Southwest Basin is 20.8 acres x 67 cy/acre = 1,393.6 cy. The design wet storage volume for the basin is approximately 2,579.6 cy, which exceeds the minimum requirement.

- Sediment basins meet the criterion.

Design Criterion 6

Half of sediment basin volume shall be dry storage = 67 cy/acre (1,809 cf/acre).

Discussion

The required dry storage volume for the Southeast Sediment Basin is 7.8 acres x 67 cy/acre = 522.6 cy. The dry storage volume is the volume above the wet pool and below the top of the principal spillway riser structure. The design dry storage volume is approximately 1,097 cy, which exceeds the minimum requirement.

The required dry storage volume for the Southwest Sediment Basin is 20.8 acres x 67 cy/acre = 1393.6 cy. The design dry storage volume is approximately 2,951 cy, which exceeds the minimum requirement.

Note: The dry storage includes the forebay cell, which can be credited to 25% of the total dry storage volume.

- Sediment basins meet the criterion.

Design Criterion 7

The dry storage volume is to be dewatered down to the permanent pool in 72 hours.

Discussion

The dewatering device specified for the sediment basins is a floating surface skimmer. The skimmer sizes were determined based on the total volume to be dewatered within the specified time (72 hours) and manufacturer-provided flowrates. J.W. Faircloth & Son, Inc. provide a skimmer-sizing table on their website (<https://www.fairclothskimmer.com/skimmer-sizing>). Based on the dry storage volume of the Southeast Basin (29,627 cf), dewatering within 72 hours requires a 4" Faircloth skimmer with a 2.8" diameter orifice, according to the sizing table. Using the dry storage volume of the Southwest Basin (79,681 cf), dewatering within 72 hours requires a 5" Faircloth skimmer with a 4.5" diameter orifice, according to the sizing table.

- Sediment basins meet the criterion.

Design Criterion 8

The minimum required pond surface area is calculated by the following empirical formula:

$A_s = 0.01Q_p$, where A_s = Surface area (acres), and Q_p = peak flow (ft³/s) for the design storm (5- year, 24-hour).

Discussion

The model-predicted peak runoff flow for the Southeast Sediment Basin drainage areas is 39.90 ft³/s. Therefore, the required pond surface area for the Southeast Sediment Basin is:

$$A_s = (0.01) (39.90 \text{ ft}^3/\text{s}) = 0.3990 \text{ ac} = 17,379 \text{ ft}^2.$$

The design surface area (top of dry storage/principal spillway) for the Southeast Sediment Basin is 17,695 ft², which exceeds the minimum requirement.

The model-predicted peak runoff flow for the Southwest Sediment Basin drainage areas is 86.82 ft³/s. Therefore, the required pond surface area for the Southwest Sediment Basin is:

$$A_s = (0.01) (86.82 \text{ ft}^3/\text{s}) = 0.8682 \text{ ac} = 37,819 \text{ ft}^2.$$

The design surface area (top of dry storage/principal spillway) for the Southwest Sediment Basin is 43,987 ft², which exceeds the minimum requirement.

- Sediment basins meet the criterion.

Design Criterion 9

A minimum depth of 3 feet shall be designed for the permanent pool.

Discussion

The design permanent pool (wet storage) depth for both the Southeast and Southwest Sediment Basins is 3.0 feet, which meets the minimum criterion.

- Sediment basins meet the criterion.

Design Criterion 10

The forebay compartment of the dry storage area must have at least 2 porous baffles to promote more effective settling.

Discussion

The design for both the Southeast and Southwest Sediment Basins includes two porous baffles across the width of the basin.

- Sediment basins meet the criterion.

Design Criterion 11

The forebay volume shall be at least 25% of the dry sediment storage volume.

Discussion

The forebay volume for the Southeast Sediment Basin is approximately 333 yd³, which exceeds the minimum requirement of 25% of the dry storage volume (1,097 x 25% = 274 yd³).

The forebay volume for the Southwest Sediment Basin is approximately 794 yd³, which exceeds the minimum requirement of 25% of the dry storage volume (2,951 x 25% = 738 yd³).

- Sediment basins meet the criterion.

Design Criterion 12

The bottom elevation of the forebay should equal the top of the permanent pool elevation of the primary basin, and the forebay should be separated from the primary basin with a porous barrier such as a rock berm to promote larger particle settling and spread the incoming flow out to help prevent short-circuiting of the primary basin.

Discussion

For both the Southeast and Southwest Sediment Basin designs, the forebay bottom elevation is equal to the top of the permanent pool elevation, and the forebay is separated from the primary basin with a porous rock berm barrier.

- Sediment basins meet the criterion.

Design Criterion 13

The forebay berm overflow crest shall be set no higher than the top of the principal spillway riser crest.

Discussion

The forebay overflow crest elevation is equal to the riser crest elevation for both the Southeast and Southwest Sediment Basins.

- Sediment basins meet the criterion.

Design Criterion 14

To minimize resuspension of trapped sediment and scour in the forebay during high flows, the energy of the influent flow must be controlled as it enters and flows through the forebay. This can be in the form of a plunge pool, riprap, or other energy-dissipating control measures.

Discussion

Per both the Southeast and Southwest Sediment Basin designs, the inlet pipe discharges into the forebay onto a riprap apron on the side slope.

- Sediment basins meet the criterion.

Design Criterion 15

The rock berm shall be designed to pass the 2 or 5-year, 24-hour storm peak flow, as appropriate, without eroding the berm abutments.

Discussion

The impaired receiving water requirement is the 5-year, 24-hour storm peak flow. The forebay berm overflow bottom width for both the Southeast and Southwest Sediment Basins is greater than 50 feet, which will safely pass the design storm.

- Sediment basins meet the criterion.

C.3 Principal Spillway Design

Design Criterion 16

If the principal spillway is used in conjunction with a separate emergency spillway, the principal spillway must be designed to pass at least the peak flow expected from the 2-year (5-year), 24-hour storm.

Discussion:

The required design storm is the 5-year, 24-hour event for impaired waters. According to the CivilStorm® modeling, the principal spillways for both the Southeast and Southwest Sediment Basins can pass the 5-year, 24-hour peak storm flow with no flow passing through the emergency spillway.

- Spillways meet the criterion.

Design Criterion 17

The principal spillway riser crest must be a minimum of one foot below the crest of the emergency spillway.

Discussion

The designs for both the Southeast and Southwest Sediment Basins specify the principal spillway riser crest 1.5 feet below the crest of the emergency spillway.

- Spillways meet the criterion.

Design Criterion 18

A minimum freeboard of 1.0 foot shall be provided between the maximum 25-year pool level and the top of the embankment.

Discussion

The model-predicted maximum water elevation for the 25-year, 24-hour storm for the Southeast Sediment Basin is 894.34 ft msl, which is 1.16 feet below the top of the embankment (895.50).

The model-predicted maximum water elevation for the 25-year, 24-hour storm for the Southwest Sediment Basin is 876.88 ft msl, which is 1.12 feet below the top of the embankment (878.00).

- Spillways meet the criterion.

Design Criterion 19

Spillway foundation or embedded steel plate to prevent floating due to buoyancy.

Discussion

The spillway foundations for both basins will include a concrete base, 18 inches thick, and twice the width of their riser structures with the riser embedded 6 inches into the concrete.

- Spillways meet the criterion.

Design Criterion 20

An anti-vortex device and trash rack shall be attached to the top of the principal spillway to improve the flow characteristics of water into the spillway and to reduce the possibility of floating debris from blocking the principal spillway.

Discussion

An anti-vortex device and trash rack are specified in the sediment basin details on the construction drawings.

- Spillways meet the criterion.

Design Criterion 21

The outlet of the barrel must be protected to prevent erosion or scour of downstream areas. Measures may include excavated plunge pools, riprap, impact basins, revetments, or other effective methods.

Discussion

The barrel outlet for each sediment basin is designed to discharge onto a riprap apron.

- Spillways meet the criterion.

Design Criterion 22

Anti-seep collars shall be used on the drainpipe barrel of the principal spillway within the normal saturation zone of the embankment.

Discussion

Anti-seep collars are specified in the design for the sediment basins.

- Spillways meet the criterion.

Design Criterion 23

Dewatering: Provisions shall be made to dewater the basin down to the permanent (wet) pool elevation.

- Drawdown or dewatering must occur from the ponded water surface.
- Two types of devices are acceptable for dewatering the dry storage zone of a sediment basin.
 - (1) A section of perforated vertical pipe or tubing, which is connected to and braced to the principal spillway at two locations;
 - (2) Floating surface skimmer.

Discussion

The designs for both the Southeast and Southwest Sediment Basins will employ a skimmer to dewater the basins to their permanent pool elevations.

- Spillways meet the criterion.

This page intentionally left blank.

DOE/OR/01-2948&D2

RECORD COPY DISTRIBUTION

File—DMC—RC