

**A SURVEY OF CIVIL WAR PERIOD
MILITARY SITES
IN MIDDLE TENNESSEE**

**TENNESSEE DEPARTMENT OF CONSERVATION
DIVISION OF ARCHAEOLOGY
REPORT OF INVESTIGATIONS NO. 7**



1990

**A SURVEY OF CIVIL WAR PERIOD MILITARY SITES
IN MIDDLE TENNESSEE**

by

Samuel D. Smith, Fred M. Prouty, and Benjamin C. Nance

Tennessee Department of Conservation
Division of Archaeology
Report of Investigations No. 7
1990



Autho. no. 327320. This public document was promulgated at a cost of 2.20 each. 05/03/91.
TN Printing Div., Nashville, TN 37919-5208.

TABLE OF CONTENTS

	<u>Page</u>
List of Figures	ii
List of Tables	iii
Acknowledgements	1
Introduction	2
Historical Overview of the Civil War in Middle Tennessee	4
The Early Confederate Military in Middle Tennessee	6
The Federal Occupation of Middle Tennessee	9
Hood's Invasion of Middle Tennessee	13
The Final Phase	17
The Middle Tennessee Survey	18
Component Definitions	19
Earthworks	26
Other Fortifications	31
Battlefields	35
Encampments	41
Hospitals	41
Other Military Components Used in This Report	45
Other Components Used as Military Components in This Report	45
Conclusions	47
References Cited	55
Appendix A - Glossary of Civil War Period Military Terms Relating to Middle Tennessee Sites	61

LIST OF FIGURES

<u>Figure</u>		<u>Page</u>
1	Tennessee Counties in Middle Tennessee survey area and Civil War period military sites recorded	3
2	Map of the Middle Tennessee Area as it appeared during the Civil War period	5
3	Cross sectional diagram of an entrenchment with various kinds of associated defensive features	27
4	Entrenchment profile	28
5	Entrenchment sketches	29
6	Fortification forms	30
7	An 1864 drawing and plan of Fort Negley	32
8	An 1863 view of a Union stockade on the Louisville and Nashville Railroad	33
9	View of a Union stockade protecting a railroad bridge at Franklin, Tennessee	33
10	Early Civil War photograph showing men engaged in the construction of an elaborate stockade enclosure	34
11	Adapted from Blockhouse Sketch No. 1 by Col. William E. Merrill	36
12	Adapted from Blockhouse Sketch No. 2 by Col. William E. Merrill	37
13	Adapted from Blockhouse Sketch No. 3 by Col. William E. Merrill	38
14	Two Civil War period photographs showing Union blockhouses typical of those built in Middle Tennessee	39
15	Additional Union blockhouse photographs	40
16	Illustrations of long-term encampments	42

LIST OF FIGURES (continued)

17	Illustrations of short-term or field hospitals	43
18	An interior photograph of a long-term Union hospital and two sketches of the U. S. hospital ship D. A. January	44
19	Examples of signal stations	46

LIST OF TABLES

<u>Table</u>	<u>Page</u>
1 Civil War Period Military Sites in Middle Tennessee	20

ACKNOWLEDGEMENTS

This report discusses the results of a 1988-1989 historic archaeological site survey project, the most recent in a series of such projects conducted by the Tennessee Division of Archaeology. All of these projects have been carried out using federal matching funds administered by the Tennessee Historical Commission. During the 1988-1989 project, the United States Department of Interior Historic Preservation Fund provided 70 percent of the costs. The Division of Archaeology contributed the remaining 30 percent.

Two staff members of the Tennessee Historical Commission handled most of their agency's roll in relation to the survey. General administration of the 1988-1989 contract was provided by Stephen T. Rogers, while budgetary matters were coordinated by Linda T. Wynn.

The work that provided the basis for this report was conducted by the authors as employees of the Division of Archaeology (with Prouty and Nance serving as the archival research and field survey team and Smith serving as project director). General administration of the survey project was provided by George F. Fielder, Director of the Division of Archaeology. Other Division of Archaeology staff members who assisted with this project include Patricia Coats, who coordinated the site recording activities and entered the final site forms into the state-wide site file, Charles P. Stripling, who assisted with some of the initial site recording activities, and Jackie Berg, who assisted with the project's financial administration, typed a substantial portion of the site inventory forms, and prepared the computer-printed camera-ready copy of this final report.

Other state or federal employees who provided assistance with this project include Mike Countess (Tennessee Department of Conservation), Wayne Moore and Bob DePriest (Tennessee State Library and Archives), Pete Rogers (Tennessee Division of Parks and Recreation), Ronald Westphal (Tennessee Valley Authority's Land Between the Lakes), and the staff of Stones River National Military Park.

During the course of survey work in Rutherford County, the survey encountered an important Civil War period site that was being destroyed by a private development project in Murfreesboro. The owners of this property kindly allowed us an opportunity to salvage some artifacts and information that would otherwise have been irretrievably lost. For permission to conduct this salvage excavation we are especially indebted to Stephen L. Smith, Vice President and Project Manager for Indian Hills Golf and Athletic Club.

A number of private citizens with knowledge of Civil War period sites and history provided help with this project. Special thanks is extended to the following: Buck Allison, Mike Allison, Michael Antoniak, Willard Baker, Angela Barclay, Mr. and Mrs. Frank Baugh, Roy Blick, David L. Brown, Steve Brown, Rosalie Carter, Paul Clements, Don Crowell, J. G. Currey, Howard Davis, Doug Drake, Walter Durham, Harris Ferguson, J. Dawson Frierson, Al Gatlin, Richard Gildrie, Bert Hays, Joe Hayworth, Larry Hicklen, Milan Hill, Jim Hoobler, Tom Hoover, A. M. Johnson, Steve Johnson, David Keith, Less Marsh, Ross Massey, R. E. Naylor, Paul Pyle, Richard Quin, Robert Ragland, Rick Robinett, W. F. Rainey, James Scott, Ervin Smith, Jack Thoma, Thomas R. Todd, Tony Utley, John Whitfield, Felix Wooten, David R. Wright, Ted Yeatman, and Grady York.

INTRODUCTION

This study of Civil War period military sites in Middle Tennessee is the seventh major historic archaeological site survey project conducted by the Tennessee Division of Archaeology. This series of projects was initiated in 1977. The general types of surveys previously conducted have include thematic, cultural resource, state-owned areas, and representative county. The various forms of thematic surveys have proven to be the most useful for assessing individual site significance. Where a thematic survey has been conducted, it is much easier to make site evaluations for the purposes of state and federal review and compliance procedures, for determining National Register eligibility, and for deciding where best to expend financial and human resources in an effort to mitigate the loss of sites by the various agents of site destruction. An overview of this previous work is discussed in an article in a recent issue of the journal Historical Archaeology (Smith 1990).

The 1988-1989 survey of Civil War sites was designed as a thematic survey. For several years it had been apparent that this particular site category was unusual in that it was simultaneously of great interest to a large number of relic collectors but was greatly under-represented in the state-wide site file maintained by the Division of Archaeology. Previous to the 1988-1989 survey, only eleven Civil War Period military sites had been recorded for the entire Middle Tennessee area, with similarly low numbers for the remainder of the state. The potential number of such sites, however, was obviously very large. During the Civil War, Tennessee was second only to Virginia in total numbers of campaigns, battles, skirmishes, and similar actions (Dyer 1908: 595). It was clear that survey work focusing on this topic would supply some much needed information concerning one of the poorest understood segments of the Tennessee historic site data base.

The need for such surveys had also already been demonstrated in an excellent study of Civil War field fortifications in the "Western Theater" by David Wright (1982). This document was used extensively during development and implementation of the present survey, and it is highly recommended as a source of information for understanding the physical manifestations of the Civil War in the mid-South.

To begin to develop an understanding of Civil War period military sites in Tennessee, it was proposed to carry out a single regional survey. For various time and logistical reasons, the Middle Tennessee area was selected for this initial project. While the decision to conduct the survey in this area was largely a matter of convenience, Middle Tennessee (Fig. 1) is a rather distinct region in terms of the Civil War activity that occurred here. The Confederacy's loss of Forts Henry and Donelson in early 1862 opened the way for the Federal occupation of Middle Tennessee, and subsequent fighting for control of this area was intense (Wright 1982: 66).

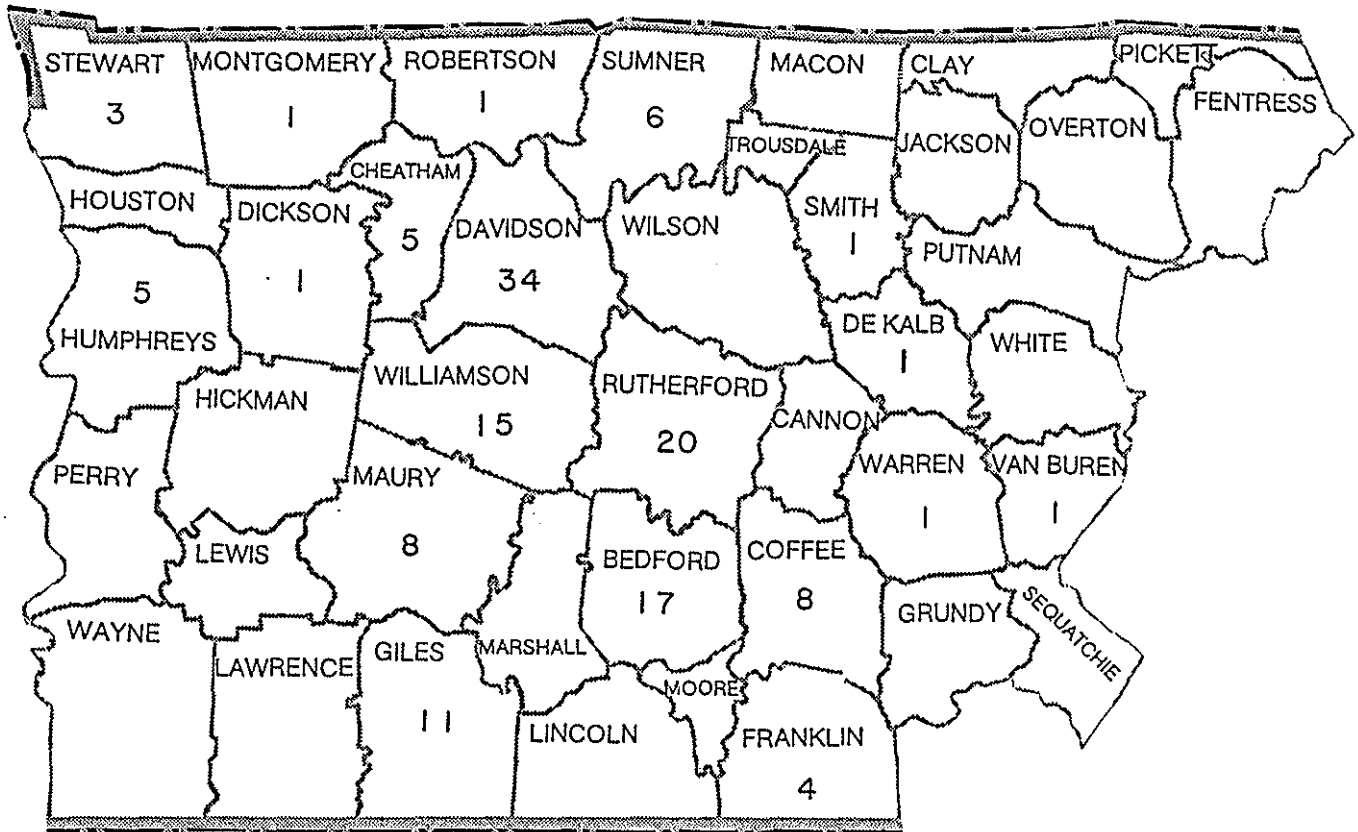
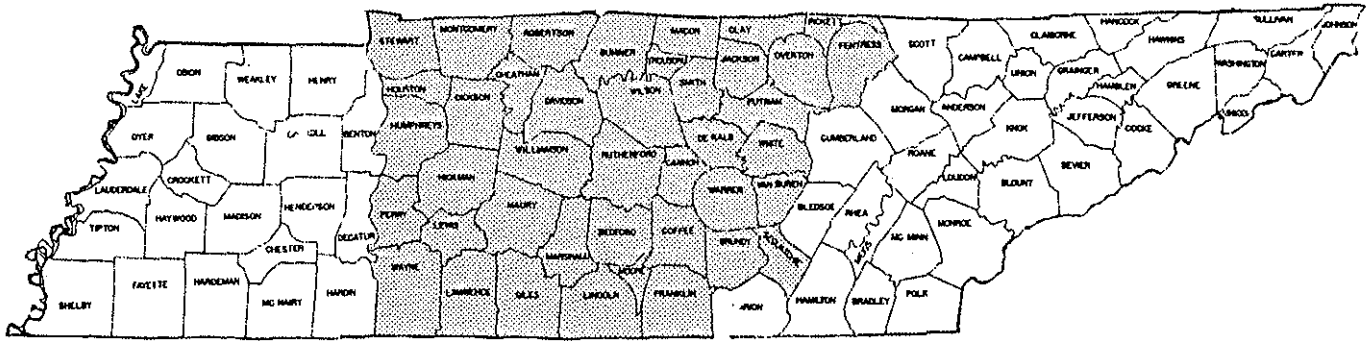

Figure 1. Tennessee counties in Middle Tennessee survey area and Civil War period military sites recorded as of February, 1990.

As with similar past projects the first phase of survey work in 1988 was devoted to archival research. Most of this research was carried out at the Tennessee State Library and Archives. In addition to examining the large volume of "official" records concerning the Civil War, it proved very productive to examine the often locally-produced county histories for the various counties that make up the Middle Tennessee area. Local writers have always been interested in the Civil War, and few county historians have failed to include mention of those activities that occurred in their counties.

The survey project was initiated with a list of probable site types, and during the archival and early site survey phases this was developed into a very specific list of military "components" (with one or more components occurring at each site). Eventually it became apparent that two of these "components" ("minor battlefields" and "short-term encampments") were of such limited archaeological potential that there was little need to spend much time trying to record them. This eliminated a numerically large number of occurrences and made it possible to think of the recording effort as one that it might be possible to complete.

From the beginning of this project it was planned to make as much use as possible of informant information concerning sites and artifacts. This approach worked better than anticipated. A number of very knowledgeable informants willing to help with the project were found, and the recording of sites progressed at a greater than expected rate. Near the end of the initial field work phase a small extension to the project was granted, and this permitted what had been envisioned as possibly no more than a "site-sample" survey to become a rather complete survey of Civil War period military sites in Middle Tennessee.

HISTORICAL OVERVIEW OF THE CIVIL WAR IN MIDDLE TENNESSEE

During the course of the War Between the States, Tennessee became one of the chief battlegrounds. By one writer's estimate (Dyer 1908: 595) it was the scene of at least 1,462 individual campaigns, battles, skirmishes, and similar actions (second only to Virginia, with 2,150 such actions). A majority of the Tennessee actions took place in the Middle Tennessee area, which was part of a much larger region known as "The Western Theater."

While Tennessee is divided into nine or ten physiographic or geologic regions (Luther 1977), it has traditionally been regarded as composed of three major political subdivisions. By 1860, the factors distinguishing these areas were very well defined. In West Tennessee, with its rich lowlands and numerous large plantations, a strong pro-slavery, pro-Democrat, pro-Confederacy sentiment existed. East Tennessee, with its predominantly mountainous terrain, few plantations, and relatively few slaves, had a pro-Republican, pro-Union sentiment. In Middle Tennessee (Fig. 2), which includes the Central Basin and the Eastern and Western Highland Rims, feelings were mixed, but support for the Confederacy was dominant. The weight of sentiment felt in this area finally brought Tennessee into the Confederate ranks on the 6th of May 1861 (Todd 1983: 1185).

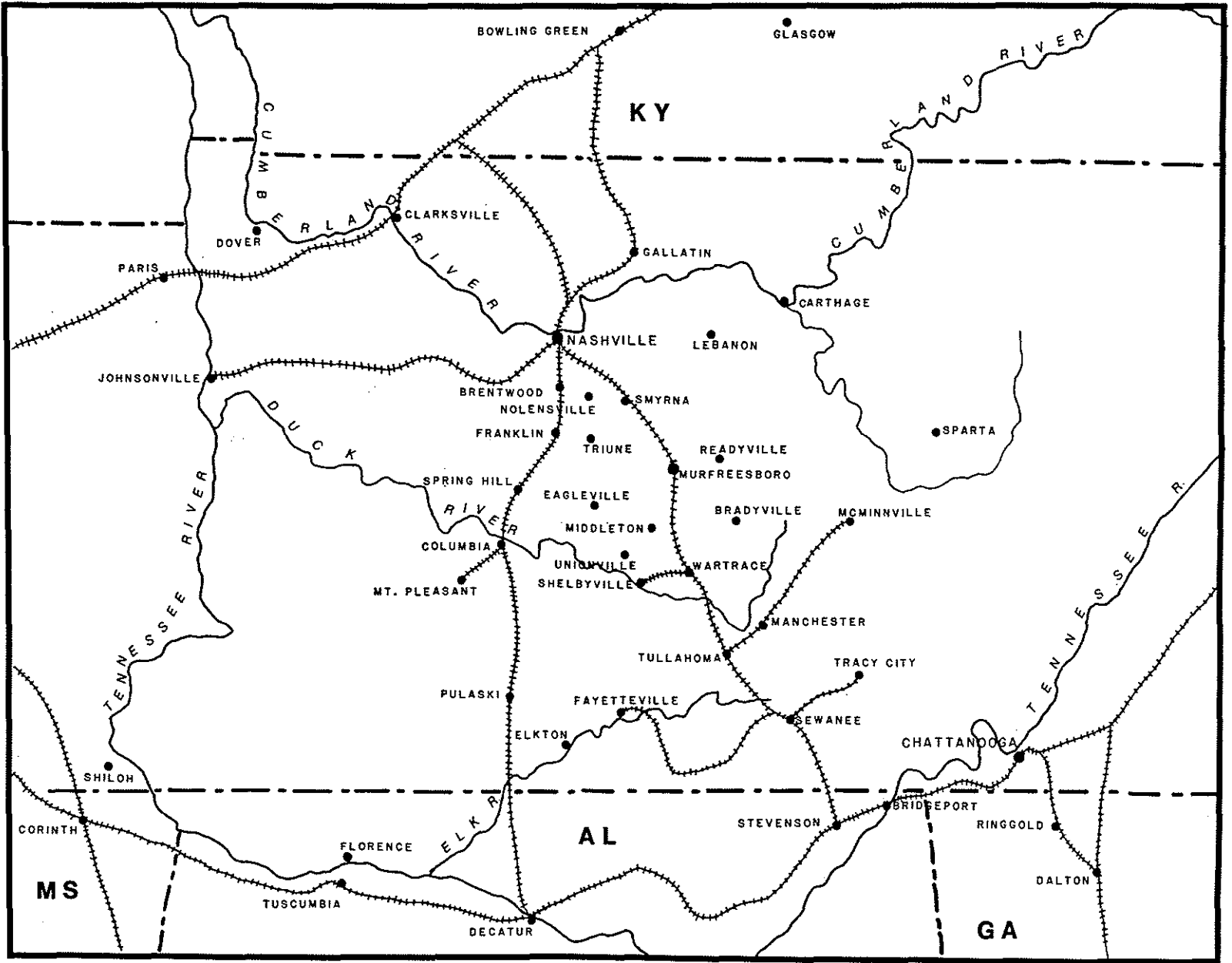

Figure 2. Map of the Middle Tennessee Area as it appeared during Civil War period (including towns, railroads, and major streams).

The Early Confederate Military in Middle Tennessee

At the beginning of the war, a number of Confederate training camps sprang up in Middle Tennessee. These included Camp Harris, some 80 miles south of Nashville, Camp Trousdale in Sumner County, and Camp Cheatham near Springfield. Camp Boone, just north of Clarksville, was formed to recruit Kentuckians who wanted to join the Confederacy in defiance of their own state's avowed neutrality (Horn 1977: 5).

The provisional Army of Tennessee, with a strength of 55,000 troops, including infantry, cavalry, artillery, and independent companies, was transferred to Confederate service on July 31, 1861 (Horn 1977: 5; Todd 1983: 1189). By 1862, it was known as "The Army of Tennessee" and remained the principal Confederate army west of the Appalachians until the end of the war in 1865. The majority of Confederate troops active in the Middle Tennessee area belonged to The Army of Tennessee.

During the early stages of the Civil War, the Confederate states faced the problem of protecting their left flank, which extended along the north border of Tennessee and along the southern border of Missouri. Tennessee was vulnerable to Federal invasion by means of the Cumberland, Tennessee, and Mississippi rivers (Wright 1982: 65-66). Adna Anderson, a civil engineer of the Edgefield and Kentucky Railroad was appointed by Tennessee Governor Isham Harris to select sites for fortifications on the Cumberland and Tennessee rivers. By late June of 1861 construction had begun on Fort Henry on the Tennessee and Fort Donelson fifteen miles east on the Cumberland near Dover, Tennessee (Ridley 1978: 64-66).

In September of 1861, General Albert Sidney Johnston, commander of the Confederate troops west of the Alleghenies, was informed that Fort Henry was being constructed in a poor defensive location. He sent Major Jeremy F. Gilmer, his chief engineer, to investigate the situation. As a result of Gilmer's inspection it was decided to construct an additional work, called Fort Heiman, on a high bluff on the Kentucky side of the Tennessee River (Horn 1987: 78). Major Gilmer, who became known as "Johnston's dirt digger" (Horn 1987: 78), also selected sites at Clarksville, Tennessee, to defend an important railroad bridge over the Cumberland River (OR, series 1, vol. 5, p. 479, Johnston to Cooper, October 27, 1861). The loss of Clarksville would open the door for Federal troops to attack Tennessee's capital, Nashville, some thirty miles downstream.

In order to protect central Tennessee and south central Kentucky, Johnston, on September 15, 1861, ordered Brigadier General Simon Buckner to occupy Bowling Green. The Confederate left flank now presented three main fronts: the left at Columbus, Kentucky, the defenses of which were considered to be impregnable to Union gunboats; the center at Bowling Green, Kentucky; and the right at Cumberland Gap. By this time several other forts were also under construction on the Mississippi River in West Tennessee, including Fort Pillow, which was located 40 miles above Memphis. These Mississippi River bluff forts were intended to deter a Union effort to send flotillas down the river and divide the South (Wright 1982: 73).

By January of 1862, General Johnston's analysis of the situation led him to believe that the Federals would attempt to turn his left with an advance up the Tennessee River, while exerting pressure on Bowling Green (Horn 1987: 75-83;

Ketchum 1960: 113-120). Both Johnston and Chief Engineer Gilmer were of the opinion that Nashville and points along the river between it and Fort Donelson should be fortified, but their concern was not taken seriously by their superiors in Richmond. Only limited work was carried out at these locations at this time (Horn 1987: 79; Ketchum 1960: 113-120). Gilmer made an attempt to fortify Nashville with the construction of a river defense known as Fort Zollicoffer, but its construction, including the mounting of several heavy artillery pieces, was severely hampered by the fact that there were few laborers left in Nashville. All available black workers were being used in other projects, and most of the white labor force was already in government service (QR, series 1, vol. 52, pt. 2, p. 200, Gilmer to Johnston; Wright 1982: 77-85).

The Union forces, realizing that control of the Cumberland and Tennessee rivers would leave Middle Tennessee and the Confederate heartland open to invasion, launched their offensive on February 6, 1862, with Federal infantry forces under General Ulysses S. Grant and naval gunboats under Admiral Andrew H. Foote. The Union fleet quickly passed Fort Heiman, which had been abandoned by its defenders, and engaged the few guns mounted at Fort Henry. Within one hour the Confederate troops at Fort Henry surrendered (Brandon 1944: 34-41).

On February 14, the Federal gunboats began bombarding Fort Donelson. Following the arrival of General Grant's infantry and two days of fierce combat, General Simon Buckner, asked Grant for terms of surrender. Grant replied: "No terms except unconditional and immediate surrender." On February 16, Buckner complied, and close to 12,000 Confederates became prisoners of war. From this time forward, General Grant would be known as "Unconditional Surrender Grant" (Davis 1981: 267-268).

The loss of Fort Donelson left the way open to Clarksville where, according to Brigadier General John B. Floyd, C.S.A., "the defenses amounted to about nothing" (QR, series 1, vol. 7, pp. 860 and 865). On February 19, the Union fleet was met by a white flag flying at Fort Defiance, which though it was Clarksville's main defensive position was still incomplete - Fort Defiance was later renamed Fort Bruce in honor of a Union sympathizer, a Colonel Bruce from Nashville, and its fortifications strengthened by Federal troops (Wright 1982: 98).

Referring to the situation at this time, David Wright (1982: 121-122) notes that:

The Confederates, in their attempt to stop the Federal invasion of Tennessee, had tried to establish an early defensive perimeter of fortifications that failed to hold their ground, due to a breakdown in command structure, poor site selection, and inadequate defense of the forts themselves. These early war field fortifications [the remains of some being extant today] reflect a unique type of military architecture and are invaluable sources of design information and techniques used by the West Point graduates and civil engineers within the Confederate Corps of Engineers.

With the loss of Forts Henry and Donelson and the Clarksville positions, nothing stood between the Union fleet and Nashville. General A. S. Johnston, now encamped at Edgefield, across the river from Nashville, realized that these losses would likely lead to the overrunning of a large section of Tennessee (Horn 1987: 99-100). With Nashville unfortified and indefensible to the Union fleet, Johnston

decided that "The situation left me no alternative but to evacuate Nashville or sacrifice the army" (OR, series 1, vol. 7, p. 426). The Confederate forces retreated south out of Nashville on February 23, 1862. The panic that occurred among the local population was held in check to some extent by the presence of Colonel Nathan B. Forrest, who had escaped capture at Fort Donelson (Durham 1985: 32-26).

Nashville, by this time, had become an important military supply depot for the Southern cause. This included the production of artillery guns and munitions at the T. M. Brennan Works, swords at the College Hill Arsenal and the Nashville Plow Works (Daniel and Gunter 1977: 27-39; Albaugh 1960: 15-18 and 87-90), and the beginning stages of production of cavalry carbines at the Nashville Armory (Hill and Anthony 1978: 126). There were also firms for manufacturing percussion caps, saddles, harness, uniform cloth, belt buckles, and other essentials. Colonel Forrest was able to remove large portions of these military stores, even as Governor Harris and the Tennessee legislature loaded the archives of the state onto the noon train for Memphis (where the state government remained until Memphis surrendered to Federal gunboats in June of 1862) ((Durham 1985: 4-12).

Following the Confederacy's loss of the Tennessee and Cumberland River positions, the Mississippi River defences at Columbus, Kentucky, were abandoned on March 2, 1862. This was the last Confederate stronghold in Kentucky (Wright 1982: 100). General Johnston next marched his forces to Corinth, Mississippi. From this position he hoped to protect two major railroad lines, including a direct route to Virginia. Corinth was also an important location because of its proximity to Memphis and to the Tennessee River, which provided access to Chattanooga (Horn 1977: 7).

After reorganizing his Army at Corinth, Johnston moved his force of 40,000 men northward, and on April 6, 1862, attacked an army of some 37,000 Federal troops under the command of General Grant at Shiloh (Pittsburgh Landing), Tennessee. Grant's troops had moved to this position by way of the Tennessee River, following the fall of Fort Donelson. In this surprise attack, the Confederate forces gained success early in the battle, but after the mortal wounding of General Johnston, the momentum was lost. The Confederate command was shifted to General P. G. T. Beauregard. The next morning, fresh Federal troops under Brigadier General Don Carlos Buell, who had arrived during the night, turned the tide of battle, and Beauregard withdrew his army to Corinth (Horn 1977: 7; Sword 1983: 115-140; McDonough 1977: 152-153). Confederate General Patrick Cleburne later said of the Battle of Shiloh "It was a battle gallantly won and stupidly lost" (Purdue 1973: 119).

At the same time that the fighting was occurring at Shiloh, an important fortified Confederate garrison on Island No. 10 in the Mississippi River and the town of New Madrid, Missouri, fell to combined Union naval and infantry forces. This set the stage for Federal control of the Mississippi River (Ketchum 1960: 132).

Following the Battle of Shiloh, General Braxton Bragg was placed in command of The Army of Tennessee, the main portion of which was relocated to Chattanooga, Tennessee, in July of 1862 (Horn 1977:11). From here, Bragg attempted an invasion of Kentucky, which was successful until Bragg lost the initiative. After inept action at the battle of Perryville, Kentucky (October 8, 1862), Bragg withdrew his army to Murfreesboro, Tennessee. General Don Carlos Buell, commander of the Army of the Ohio, let the retreating Confederates go unmolested. The United States War Department was very displeased with this inaction on

Buell's part, and they soon replaced him with General William Rosecrans (Ketchum 1960: 245).

The Federal Occupation of Middle Tennessee

Following their victories at Fort Henry and Fort Donelson, and the fall of Clarksville, portions of the Federal Army moved directly to Nashville. On February 25, 1862, Federal troops crossed the Cumberland River and took possession of the city. These Federal soldiers greatly outnumbered the civilian population, and from this point on Nashville began to evolve into the war materials depot for the entire Western Theater. Churches, schools, warehouses, and homes were all pressed into military service (Hoobler 1986: 19). On March 3, 1862, President Lincoln appointed Senator Andrew Johnson to serve as Military Governor of Tennessee. This was the first such appointment of the Civil War (Durham 1985: 56-58). During the early portion of the occupation of Nashville, most of the Federal troops belonged to General James S. Negley's and General John M. Palmer's divisions. Their hold on the city, however, was made uncertain by the presence of Confederate troops under General Braxton Bragg at Murfreesboro (Van Horne 1875a: 207-208). This situation demanded a strengthening of the Federal position.

On October 24, 1862, Major General William S. Rosecrans was given command of the "Department of the Cumberland," which at that time encompassed the portions of Tennessee lying east of the Tennessee River, as well as portions of northern Alabama and Georgia. The troops in this department were soon being called the "Army of the Cumberland." A principal objective for this army was the maintaining of Nashville and the surrounding area as a major base of supply and a concentration point for troop strength. On November 4, 1862, General Rosecrans ordered a large body of troops relocated from Bowling Green, Kentucky to Nashville, and on November 9th, troops from Glasgow, Kentucky, took possession of Gallatin, Tennessee, running Confederate cavalry troops commanded by General John Hunt Morgan out of the area (Van Horne 1875a: 207-208).

Prior to General Buell's removal as commander of the troops in Tennessee and Kentucky, Captain James St. Clair Morton, an engineer in the Corps of Engineers who had ranked second in his West Point class of 1851, was assigned the roll of Buell's chief engineer. Morton began constructing "stockades" on the Nashville and Chattanooga Railroad in July of 1862 and by the end of the month had constructed fourteen of these defenses, which were of simple rectangular design with loopholes cut into the walls for the firing of rifles. Some of them also had four circular corner bastions with diameters designed to accommodate Sibley tents, which were used as troop quarters (Van Horne 1875b: 443). These stockades were constructed at major railroad bridges on one or both sides of the river (Wright 1982: 123-124).

Also previous to Buell's removal, Governor Andrew Johnson requested that Nashville be fortified with redoubts and other works. On November 6, 1862, Captain Morton was ordered to Nashville to select sites and design fortifications overlooking the major thoroughfares. Morton decided on a four-gun position on Saint Cloud's Hill (later named Fort Negley) and a four-gun work around the State Capitol building. He also fortified the bridge over the Cumberland River. Captain Morton faced the same man-power problems that Confederate engineer Gilmer had experienced nine months earlier. Morton's solution was to impress 2,000 blacks,

and with these men work progressed rapidly. By the end of 1862, four large forts had been constructed on Nashville's prominent hill tops (Wright 1982: 123-127; Horn 1956: 24-29).

On November 7, 1862, General Rosecrans appointed Major General George H. Thomas commander of the "Center" of operations for the Army of the Cumberland and placed him in charge of the Nashville area (Van Horne 1875a: 210-211). During the remainder of the year, Thomas' forces were engaged in strengthening the Nashville defenses and making reconnaissances and offensive sorties into the surrounding communities. They also began the construction of earthworks in places such as Gallatin, Hartsville, LaVergne, Franklin, and Triune and established a number of "blockhouses" to defend vital railroad trestles (Van Horne 1875a: 287-293). These blockhouses, with heavy sod covered roofs and protective dirt embankments piled to the level of the loopholes, were a major improvement over the earlier stockades in terms of their defensive strength (Van Horne 1875b: 439-452).

The day after Christmas, 1862, General Rosecrans moved his 47,000 man army out of Nashville and encountered, on December 31, Confederate General Braxton Bragg's Army of Tennessee at Murfreesboro on the Stones River (Van Horne 1875a: 218). The Confederates pressed the attack and pushed the Federals back until night fall. After two days of intensive combat, Bragg was informed that reinforcements for Rosecrans army had arrived, and he wrote "Common prudence and the safety of my army ... left no doubt as to the necessity of my withdrawal from so unequal a contest." The two days of fighting had cost the Confederates 12,000 casualties, while the Federal loss was 13,000 (Ketchum 1960: 284-289).

On the evening of January 3, 1863, the Confederates withdrew from Murfreesboro and retreated 36 miles to the south. In spite of what appeared to be a numerical victory at Murfreesboro, Bragg's removal of his army from the field left his troops in a demoralized state. According to Horn (1987: 210), the Confederates were "physically miserable and spiritually depressed" as they plodded south in the rain and pelting sleet. These troops were next deployed around the towns of Shelbyville, Wartrace, and Tullahoma, Tennessee, where they established winter quarters and began constructing long lines of defensive earthworks, north of the Duck River (Wright 1982: 131-132).

Meanwhile, Rosecrans, who made no attempt to pursue Bragg, spent the next six months reorganizing his army and cavalry and building Murfreesboro into a huge secondary supply depot. Much of this was located within the walls of a massive earthwork named Fortress Rosecrans. There were also large troop encampment areas located in and around the city, especially forward of the main line on the south side of town (QR, series 1, vol. 23, pt. 1, p. 65).

On January 25, 1863, forts Henry, Donelson, and Heiman were transferred to General Rosecrans and with them the responsibility for maintaining open navigation of the Cumberland River (Van Horne 1875a: 288). Also during early 1863, the Federals were involved with numerous small actions, reconnaissances, and skirmishes in or around such places as Triune, Unionville, Rover, Eagleville, Franklin, Carthage, Brentwood, Nolensville, Columbia, Spring Hill, Thompson's Station, Middleton, LaVergne, and Fort Donelson (Van Horne 1875a: 288-300). In many of these towns or communities, there are surviving earthworks that were constructed and manned by the Federal soldiers at this time.

In the spring of 1863, a "sister" work to Fortress Rosecrans was built in Franklin, Tennessee. Named Fort Granger, in honor of Major General Gordon Granger, the commander of the United States forces at Franklin, it was constructed under the supervision of Captain W. E. Merrill of the United States Corps of Engineers, who arrived in Franklin on March 7, 1863 (Dilliplane 1966: 11-12). Fort Granger was used to guard the Decatur Railroad bridge over the Harpeth River and the approaches to Franklin. Several other small fieldworks were constructed north of Fort Granger to command the higher points around the city. One of these knolls, known as "Roper's Knob," has visible remains of a line of rifle pits, a redoubt for four heavy guns, a magazine, and a blockhouse that held 50 men (OR, series 1, vol. 23, pt. 2, p. 113). Another nearby hill had a Federal lunette-style battery that appears from the remains to have contained all the classic elements of this type defense.

On March 5, 1863, troops under the command of Union General Steadman of the 14th Army Corps began constructing what became a massive series of earthworks, located several miles east of Franklin on the hills overlooking Triune, Tennessee. These works consisted of three artillery redoubts on the tops of the highest hills and several miles of interlinking breastworks. The camps for the more than 10,000 men stationed there were located nearby (Jordan 1935: 13-18).

The remains of a surprising number of the works constructed by the Federal troops occupying Middle Tennessee in 1862 and 1863 continue to exist in a relatively good state of preservation. In this context the phrase "well preserved" means that the earthworks retain their original configurations, but are, nevertheless, often vague in overall appearance. Most of the temporary fortifications constructed in the Western Theater of War were fabricated with specialized building materials. The earthen walls were revetted with breast height gabions, the embrasures revetted with fascine, and the traverses built of hurdle-work (see Appendix A), all of which quickly deteriorated. This helps to explain the eroded and delicate condition of many extant earthworks now in need of preservation (Wright 1982: 130).

By mid-1863, The Army of Tennessee, with an approximate strength of 44,000 men, had spent six months in camps near General Bragg's new defensive line along the Duck River. The left wing of this Confederate line was under the command of General Leonidas Polk at Shelbyville, while the right, under the command of General William J. Hardee, centered on the communities of Liberty and Hoover's Gap, north of Wartrace. The Confederate cavalry extended this line on the left to Columbia and on the right to McMinnville. Immediately in front of Polk's and Hardee's corps, a strong system of breastworks, several miles in length, had been completed (Van Horne 1875a: 302; Hughes 1985: 118-130; Fremantle 1863: 155-159).

Union General Rosecrans knew that if he attempted to attack Bragg's seventy mile defensive line by direct assault the casualties would be enormous. Instead, Rosecrans, moving out of Murfreesboro on June 23, 1863, used a series of small but fierce actions to flank Bragg and force The Army of Tennessee to retreat south. One of these actions was the Federal advance through Hoover's Gap on June 24, 1863, which was successfully accomplished by the use of Colonel John T. Wilder's Mounted Infantry Brigade. General Rosecrans' army was short on cavalry at this time, and Colonel Wilder was permitted to have the 17th Indiana Infantry Regiment mounted and equipped with the Spencer repeating rifles and carbines. These seven shot, .52 caliber guns produced a high rate of fire and added greatly to

the shock power of Wilder's brigade (Sunderland 1984: 36-50; Reilly 1970: 59-63 and 163; Coggins 1962: 35).

Following other defeats similar to the one at Hoover's Gap, Bragg's forces repositioned themselves behind strong earthworks at Tullahoma, Tennessee. These works made a semicircle around the town, and a 600 yard swath of abatis was placed in front as a defensive obstruction. There were also two large bastioned forts near the center, commanding the breastworks (Van Horne 1875a: 302-309; Wright 1982: 131).

General Rosecrans continued to flank Bragg's right and captured the town of Manchester, again threatening to cut Bragg off from his supply line to Chattanooga, Tennessee. Bragg withdrew his troops to Chattanooga in an effort to protect this vital railroad base. This brought to an end the "Tullahoma Campaign," and according to Wright (1982: 131-132):

The success of this campaign would raise serious doubts in the minds of military leaders on both sides as to the effectiveness of earthworks in battle situations. Especially as to how an army could prevent an aggressor from outflanking defensive positions and yet impede his forward movement.

In September of 1863, General Rosecrans' Army of the Cumberland moved south through Chattanooga and engaged the Confederates at the Battle of Chickamauga, which was fought just over the Georgia line. The defeated Federals were driven back to Chattanooga, and only the resolute actions of Major General George H. Thomas ("The Rock of Chickamauga") kept it from becoming a total rout. The besieged Federal troops in Chattanooga were soon relieved by additional troops, and General Grant took charge of the military operations at Chattanooga. He replaced General Rosecrans with General Thomas, and in November of 1863 defeated The Army of Tennessee at Missionary Ridge (Horn 1987: 298-304).

Bragg's troops withdrew to Dalton, Georgia, where he was relieved of command and replaced with General Joseph Eggleston Johnston. The Army of Tennessee next fought in the Atlanta Campaign, during which period Johnston was replaced by General John Bell Hood (Horn 1977: 7).

Just prior to the Battle of Missionary Ridge, Major General James Longstreet, on loan from the Army of Northern Virginia, had been sent by Bragg to attack the Federal troops at Knoxville, who were under the command of Major General Ambrose E. Burnside. Before Longstreet could effect any decisive moves, word came to him of Bragg's defeat, and he lifted the siege of Knoxville and moved his army north to Morristown, where he spent the winter of 1863-64 (Horn 1977: 8).

Following the military engagements in and around Chattanooga, there was little fighting in the Tennessee region for almost a year except for the actions of Confederate General Nathan B. Forrest. During the late fall of 1863, Forrest had been relieved from duty with The Army of Tennessee so that he could raise new troops from stragglers in West Tennessee. During the ensuing months his cavalry troops were engaged in numerous skirmishes and minor battles in northern Georgia, Mississippi, and West Tennessee, before he was eventually ordered to join General John B. Hood in his invasion of Middle Tennessee (Caldwell 1968: 117-119).

During the first few months of 1864, the Federal troops of the Army of the Cumberland, under General Thomas, were placed from Knoxville to Bridgeport, Tennessee, and along the railroad from Bridgeport to Louisville, Kentucky. During this period, General Thomas sent scouting parties in all directions with very little contact from Confederate forces. With much of the Army of the Cumberland so widely dispersed, the number of Federal troops in Middle Tennessee was greatly reduced from what it had been the previous year (Van Horne 1875b: 13-15 and 30).

Hood's Invasion of Middle Tennessee

After the fall of Atlanta to Sherman's forces in September 1864, The Army of Tennessee fought its way out of Georgia into Alabama and prepared to carry out General Hood's plan to invade Middle Tennessee. Hood's apparent intention was to move rapidly north, capture Nashville, or bypass it if necessary, and move on to Louisville, Kentucky, or perhaps Cincinnati, thereby putting a wedge into the middle West and drawing Sherman out of Georgia (Horn 1987: 377-384). Had this succeeded, he might then have crossed the Cumberland Mountains and attacked General Grant's army, which was engaged with General Robert E. Lee's forces near Richmond, Virginia (Ketchum 1960: 546).

Instead of pursuing Hood, General Sherman turned his attentions south and began his "March to the Sea." In his place, Sherman sent his ablest subordinate, General George H. Thomas, back to Nashville, where he gathered a force of 50,000 Federal soldiers to secure Middle Tennessee (Ketchum 1960: 545-547).

Meanwhile, General Forrest, enroute to join Hood, conducted one of his last and most famous raids on a large Federal supply base at Johnsonville on the Tennessee River at the western edge of Middle Tennessee. In late October, 1864, Forrest established several artillery positions on the west side of the Tennessee River and managed to capture a Federal gunboat and three transports. Two of the transports were stripped of their cargo and burned; the gunboat and remaining transport were manned by Confederate cavalymen. These were operated on the river until they were finally recaptured or destroyed (Horn 1977: 8; Wyeth 1975: 515-533).

During this diversion with the captured boats, Forrest's men had placed ten artillery pieces in positions to fire on Johnsonville. On November 4, at 2:00 pm, the Confederates began to bombard the Federal boats and facilities on the east bank of the river. The Federal garrison took cover in its lower redoubt overlooking the Johnsonville docks and returned fire with little effect. By 4:00 pm, most of the ships and land facilities were ablaze, and shore commanders decided to set fire to the remaining boats to keep them from being captured. By dark, 4 gunboats, 14 steamboats, 17 barges, and 75,000 to 120,000 tons of quartermaster stores had been destroyed, and approximately 150 Federals had been taken prisoner. Estimates of damage ranged from 2 to 6 million dollars. Forrest's losses were 2 killed and 9 wounded. Following the Johnsonville raid, Forrest took his command to Florence, Alabama, where he joined General Hood's forces. On November 18, Forrest was placed in command of all the cavalry of The Army of Tennessee (Garrett 1963: 103-109; Higgs 1976: 85-88).

On November 21, 1864, Hood's Army of Tennessee marched north crossing the border into southern Middle Tennessee. Their destination was Columbia,

Tennessee, where Hood hoped to interpose himself between General Thomas at Nashville and General John Schofield's 23,000 troops at Pulaski, 30 miles south of Columbia. Both armies raced for Columbia, but Schofield's arrived first and threw up a heavy line of breastworks around the south of town (Horn 1987: 384).

Hood next planned a flanking move designed to cut off Schofield's escape route to Nashville by taking Spring Hill, which lay eleven miles to the north. He left one corps and the bulk of his artillery facing Schofield, then sidestepped the entrenched Federals with his remaining troops and crossed the Duck River several miles to the east (Ketchum 1960: 552). Moving rapidly north with General Forrest screening his moves, Hood arrived at Spring Hill late in the day of November 29th, 1864, to find it lightly held by Schofield's advanced guard and a large wagon train of supplies (Horn 1977: 8). By dark, General Patrick Cleburn's Confederate division had clashed briefly with Schofield's advanced guard and was repulsed, ending all action for the day (Horn 1987: 387). The Confederates went into bivouac for the night, and apparently due to some confusion in orders, Schofield was able to continue to move his forces north during the night without being interrupted. Upon reaching Spring Hill, his troops were able to pass the Confederate pickets, who were less than 600 yards away (Ketchum 1960: 552).

Schofield's army reached Franklin, fifteen miles farther north, at noon on November 30, 1864, and began strengthening some already existing earthworks (Horn 1987: 397-398). When complete, these rebuilt Federal breastworks had exterior ditches and earthen walls topped with protective head logs. In some sections they were fronted with abatis or angled palisades for extra defensive strength (Horn 1956: 16-18). These works were in the form of a large crescent along the south edge of Franklin, with each end of the line anchored on the Harpeth River (Horn 1987: 393). To the rear of this line, Fort Granger was manned to provide artillery support for the Federal left wing (Wright 1982: 164).

On the morning of the 30th, when Hood learned of Schofield's escape, he became furious, stating "The best move of my career ... and I was destined to see it come to naught" (Ketchum 1960: 552-553). Hood blamed his subordinates for this failure, and mercilessly marched his army at quick time until they reached the rim of Winstead Hill, south of Franklin, about 2:00 pm on November 30. After viewing the Federal line through his field glasses, he announced, "We will make the fight." This decision was vigorously denounced by the majority of his generals. The well prepared Federal entrenchments, with long open fields in front, and the fact that the main Confederate artillery support had not yet arrived from Spring Hill, made this an obviously suicidal undertaking. To this Hood replied "I prefer to fight them here where they have had only a few hours to fortify, than to fight them in Nashville, where they have been strengthening for 3 years" (Horn 1987: 397-398). Confederate General O. F. Strahl, before ordering his troops to attack, prophetically told them, "Boys, this will be short, but desperate" (Ketchum 1960: 553).

At 3 pm, Hood ordered a direct frontal assault of the Federal works, marching about eighteen Confederate infantry brigades across the open fields in front (McDonough and Connelly 1983: 104). This force soon overran an advanced line of Federal rifle pits, driving the defenders back toward the main line. The attacking troops were under heavy artillery and infantry fire, and some of the Federal troops, specifically Colonel John Casement's brigade, were armed with Spencer and Henry repeating rifles, which greatly increased their fire power (Logsdon 1988: 20; McDonough and Connelly 1983: 144-147; Schofield 1909: 40). As the Confederate

line reached the main works, a portion managed to breach the defenses near the center, but reserve forces under Union General Emerson Opdycke were soon able to plug this gap. The Confederates were forced to regroup, while still under withering Federal fire, and they subsequently made thirteen, or more, desperate charges against the Union breastworks (Ketchum 1960: 555).

Further attacks along the Federal line proved unsuccessful, and as darkness overtook the field, the surviving Confederates clung to the exterior walls and ditches of portions of the Federal works, as their only means of protection. Much hand to hand combat ensued for the next two hours, until the battle ground to a halt. That night, Schofield quietly pulled his army out of Franklin, leaving behind his dead and wounded, and by the morning of December 1, 1864, he was within the protective defenses of Nashville (McDonough and Connelly 1983: 144-147; Scofield 1909: 40-50).

The best estimate of Hood's Franklin losses is approximately 7,000 men, including 1,750 killed on the field, about 4,500 wounded, and another 702 taken prisoner. Within five hours, at least one-third of the Confederate infantry sent into battle was lost (McDonough and Connelly 1983: 157). There were five Confederate generals killed outright, and another died of wounds a few days later. Five others received lesser wounds and a twelfth was captured. Ninety field officers became casualties, and in one brigade only a captain was left to command (Horn 1977: 8). By contrast, the Federals lost only 2,326 men, of which 189 were killed (Horn 1987: 403; Riley 1989: 203).

The day after the Battle of Franklin, one of the participants, Confederate Captain Samuel T. Foster, wrote the following in his diary:

General Hood has betrayed us [The Army of Tennessee]. This is not the kind of fighting he promised us at Tusculumbia and Florence, Ala. when we started into Tenn.

This was not a "fight with equal numbers and choice of the ground" by no means.

And the wails and cries of widows and orphans made at Franklin Tenn Nov 30th 1864 will heat up the fires of the bottomless pit to burn the soul of Gen J B Hood for Murdering their husbands and fathers at that place that day. It can't be called anything else but cold blooded Murder (Brown 1980: 151).

On December 1, 1864, having allowed a day for tending the wounded and burying the dead, Hood consolidated his remaining forces and sent General Stephen Lee's corps toward Nashville. They were followed on December 2 by General Benjamin F. Cheatham's corps, and these troops began selecting defensive sites on the outskirts of Nashville. The muster rolls for Hood's army now listed only 18,702 "effective total present" (McDonough and Connelly 1983: 168; Ketchum 1960: 556). For almost two weeks Hood strengthened his defenses in hopes of luring General Thomas' approximately 70,000 men out of their strong earthworks at Nashville (McDonough and Connelly 1983: 169).

Since the Federal occupation of Nashville in 1862, the city had become the foremost center of communication, transportation, and supply for Union military activities in the Western Theater. Its protection from capture was considered a matter of major importance (Horn 1965: 24). Through a succession of military engineers, Nashville had become the most thoroughly and skillfully fortified city on

the American continent (Horn 1987: 406-407). There were two lines of earthworks encircling the city. An inner line, close to the limits of the city, was seven miles long and was supported by twenty artillery batteries. This line completely enclosed the military stores and hospitals. A longer outer line rested on a range of hills running through the outskirts of town. On one of these was located Fort Negley, the most complex fortification in the Nashville defenses and possibly the most complex interior land fortification built in the United States up to this time (Wright 1982: 170).

General Thomas placed approximately 55,000 of his troops on this outer, or front, line, while some 5,000 soldiers of the Quartermaster's Corps were given the job of defending the inner works. A cavalry force of over 10,000 troopers was assembled to support the infantry. Most of these mounted units were armed with the Spencer seven-shot repeating carbine, which gave the Federals an incredible fire power advantage over the Confederates (Durham 1987: 242-243).

General Hood's reduced troop strength was insufficient to match the long outer Federal defenses, and his entrenchments, hastily constructed under adverse weather conditions, were too short to constitute a major threat to Thomas' forces (Horn 1987: 407). Hood's right wing rested on a deep railroad cut between two major turnpikes, with a small lunette occupied by 300 survivors of General H. B. Granberry's brigade. The line extended 4 to 5 miles west where its main salient, known as Redoubt Number 1, was located. This was one of five "self-supporting detached works" that Hood, on December 10, ordered constructed to prevent the enemy from gaining the rear of his left line. Each was to hold 5 to 6 artillery pieces and a small group of infantry. A short distance south of the west wing was Redoubt Number 2, and diagonally across was Redoubt Number 3. Hood also planned to help support his left flank by building two more redoubts, numbers 4 and 5. These were still under construction at the time of the Battle of Nashville, but were, nevertheless, manned by a battery of artillery and 100 infantrymen each (Wright 1982: 175-176).

After two weeks of inactivity on the part of General Thomas, Washington authorities became concerned about his "do nothing" strategy. Thomas defended his unwillingness to attack the Confederates as due to ice and snow storms and his shortage of horses to remount his cavalry. After several days of telegraphic exchanges, General Grant, now headquartered in Virginia, sent Thomas a point blank order to attack. To make sure that this occurred, Grant started for Nashville himself, but enroute he received a December 14 telegram from Thomas stating that, "The ice having melted away today, the enemy will be attacked tomorrow morning." Grant returned to his own problems of facing Lee in Virginia (Horn 1987: 410-411).

At about 6 o'clock on the morning of December 15, 1864, in a dense fog, General James B. Steedman's division led the Federal attack by hitting the lunette and its attached lines on the Confederate far right. In spite of several desperate charges, these troops, composed largely of members of The United States Colored Infantry, were not able to turn the Confederate right, but by keeping General Cheatham's Confederate troops occupied all day, they fulfilled their assigned roll of carrying out a diversionary attack (Horn 1987: 412; Johnson and Buel 1956: 457).

The principal Federal drive was in the form of a grand wheeling movement against Hood's weak left, which soon began to crumble. By night fall of the 15th, the five key Confederate redoubts were overrun and in Federal hands. That

evening, General Hood ordered his entire line to pull back two miles and establish a new defensive front. The Confederates worked all night digging in and throwing up any kind of protection they could (Horn 1987: 411-412; Ketchum 1960: 56-559).

By the morning of December 16, Hood had reduced his previous five mile line of defenses to three. Even as he prepared to make another stand, he took the precaution, to the dismay of his troops, of sending his wagon trains to Franklin in case of defeat (Durham 1987: 246). At 4 pm, General Thomas launched a combined assault. General John McArthur's and General Darius N. Couch's commands, operating from behind hastily built earthworks, spontaneously attacked the Confederate left on the slopes of Shy's Hill. This combined with attacks by General Schofield's corps to the west and Wilson's dismounted cavalry (carrying Spencer repeating carbines) to the south of Shy's Hill led to the collapse of the Confederate left wing. As the left was overrun, the middle soon gave way, followed by the fall of the far right on Peach Orchard Hill. Now fighting a three sided battle, Hood ordered a general retreat to the south (Horn 1956: 127 and 1987: 419).

Hood displayed considerably more skill in retreat than Thomas in pursuit. With a brilliant rear guard action from General James R. Chalmers' Confederate cavalry, the battered remains of The Army of Tennessee was allowed to retreat southward through Brentwood, then Franklin. The Federal pursuit was led by General Thomas J. Wood's corps of infantry and General James H. Wilson's cavalry. After ten days and nights of battling with the retreating Confederates and following a brisk engagement with Forrest's cavalry at Richland Creek between Columbia and Pulaski, the Federals finally relinquished the pursuit on December 26, 1864 (Horn 1987: 419).

On December 27, 1864, The Army of Tennessee crossed the Tennessee River and went into winter quarters in Tupelo, Mississippi, where General Hood, at his own request, was relieved of command. Within six weeks he had marched his troops nearly 500 miles, fought two major battles, and all but wrecked his army (Horn 1987: 421). The retreat of The Army of Tennessee marked the end of major Civil War activity in Middle Tennessee and the Western Theater. The remaining portion of Hood's army, estimated at 15,000 men (McDonough and Connelly 1983: 178), was refitted in Tupelo and then moved to North Carolina. After participating in the Battle of Bentonville on March 19, 1865, it was surrendered by General Joseph E. Johnston on April 26, 1865. From its grand beginnings, The Army of Tennessee had been reduced to three remaining corps, now numbering less than 13,000 men (Ridley 1978: 553-557; Ketchum 1960: 556-559; Horn 1977: 8).

The Final Phase

Following the Battle of Nashville, substantial portions of the Federal troops in Middle Tennessee were again dispersed to other locations. Some of the troops that had followed Hood's retreating Confederate army were ordered into winter quarters in northern Georgia, Alabama, and Mississippi. By January of 1865, other portions of the Army of the Cumberland had been ordered to actions in North and South Carolina. General Thomas was also absent from Nashville during much of this period, but he returned in late February of 1865 (Van Horne 1875b: 247 and 337).

After General Robert E. Lee surrendered to General Grant at Appomatox on April 9, 1865, the Federal Army in Nashville began to dismantle its operations. Orders were issued on April 17 to substantially reduce the operations of the Quartermaster Department of the Army of the Cumberland by eliminating further purchases of animals and supplies and by prohibiting any new hiring (Durham 1987: 298). It is difficult to determine how many troops were actually in the Nashville area at this time. Van Horne (1875b: 360-370) estimates that by the end of the war the entire Army of the Cumberland contained approximately 175,000 troops, but only a portion of these remained in Middle Tennessee. General Thomas conducted the last review of Federal troops in Nashville on May 8, 1865, and it was estimated that about 20,000 troops participated (Durham 1987: 297-298). If this is a true reflection of the total number of troops that were now in Nashville, it indicates a dramatic decrease from the 70,000 present a few months earlier.

Civilian life in Nashville was rapidly changing. The number of civilians employed by the military declined from 15,715 in 1864 to 5,901 in June of 1865. Many of these civilians joined Federal soldiers who were being mustered out of service and headed north by rail and steamboat (Durham 1983: 296-297). The capitol building was returned to the Tennessee state government, and its artillery, ammunition, and breastworks were removed. The Army relinquished most of its confiscated buildings, but some remained in use as hospitals, as there were still great numbers of sick and wounded remaining under the care of the medical department (Durham 1987: 263).

Between June 1, 1865 and February 1, 1866, approximately 5,083 officers and 137,533 enlisted men were mustered out of service from the Army of the Cumberland. About 20,000 volunteer soldiers were retained in what was called the Military Division of the Tennessee, and some of these troops maintained a presence in Nashville until the 1870s (Durham 1987: 298; Van Horne 1875b: 370). Thus ended the Federal military occupation of Middle Tennessee.

THE MIDDLE TENNESSEE SURVEY

As noted in the introductory section, the survey of Civil War period military sites in Middle Tennessee was conducted by progressing from archival research and informant information to field reconnaissance and recording of individual sites. This generally followed a course of action similar to what has been employed in past thematic surveys conducted by the Division of Archaeology, e.g., historic pottery making in Tennessee (Smith and Rogers 1979) and a regional iron industry survey (Smith et al. 1988: 53-55, "Survey Methodology"). As with the study of Tennessee's Western Highland Rim iron industry (Smith et al. 1988: 57-59, "Table 1"), it was found desirable to regard Civil War period military "sites" (spatial areas) as containing one or more "components" (these are defined below).

Not unlike some other types of historic period archaeological sites, Civil War sites present their own special problems concerning site definition. In many of the field situations encountered during the survey, difficult choices had to be made concerning where to establish site boundaries, and whether or not those boundaries would actually included all of the components that were probably associated with

the Civil War activity that had occurred at this location. As it was not feasible to conduct test excavations in connection with this survey, these determinations had to be made based on informant information (if available), surface evidence (which was not always clear), and a best interpretation of what was suggested by the relevant historical documentation. Unavoidably, in many situations this resulted in some degree of subjectivity concerning what was recorded as a site.

In a similar manner some of the areas recorded as sites were actually relatively small remaining "islands" of such things as battlefields or what were originally constructed as large military complexes (fortified towns, etc.). The recording of these surviving portions as individual sites seemed desirable from the standpoint of cultural resource protection, which relies on examining individual parcels of land for their cultural resource contents. In theory, some of these kinds of sites could be better understood as "site areas" (areas remaining from what were once much larger complete sites).

In spite of such site definition problems, which again are rather endemic to historic archaeological site surveys, it seems much better from the standpoint of cultural resource management to have these localities recorded than to continue to have a virtual absence of data concerning this particular site category. Site boundaries can always be changed, and no doubt will be if archaeological excavations are ever conducted at these locations.

Once an area had been located and tentatively defined as a Civil War period military site, a more or less standard procedure of site recording followed. This included defining the area on a quadrangle map, drawing a sketch map, and making photographs (if appropriate). If privately owned artifact collections from the site were known to exist, these were often photographed. Sites located in the field were recorded on standard information forms (computer forms), assigned numbers, and entered into the statewide archaeological site file maintained by the Division of Archaeology. The results of this effort are summarized in Table 1. The permanent site numbers that were assigned to the areas can be used to order the sites within the various Middle Tennessee counties where they were found, and the sites are listed on the table in this order. A total of 143 sites (Fig. 1) was recorded (11 of these are sites that had been previously assigned numbers, but these were reexamined and in most cases redefined during the 1988-1989 survey). These 143 sites are composed of 261 military components, which are multiples of 23 military component types. The remainder of this section deals with a discussion of these components.

Component Definitions

The 143 Civil War period military sites recorded during the survey were defined on the site forms by a process of selecting from a list of numerically ordered military site categories that have been developed for use with the permanent site file. A total of 18 military site terms, several of which were developed for use during this particular survey, were used to define the components found. In addition, five other categories were used that are not specifically military terms, but were necessary to identify some of the military components recorded (e.g., a military ship yard and a military foundry). Not all of the military categories on the "Historic Site Types" list maintained by the Division of Archaeology are relevant to the present body of sites and some of them are general headings. These are not included among

TABLE 1
 CIVIL WAR PERIOD MILITARY SITES IN
 MIDDLE TENNESSEE

SITE NO.	PRIMARY HISTORIC NAME	ENTRENCHMENT	REDOUBT	REDAN	LUNETTE	PRIEST CAP	EARTHWORK (UNDETERMINED)	FORT	RAILROAD GUARD POST	STOCKADE	BLOCKHOUSE	BATTLEFIELD-SMALL ENGAGEMENT	BATTLEFIELD-LARGE ENGAGEMENT	SHORT TERM ENCAMPMENT	LONG TERM ENCAMPMENT	SHORT TERM MILITARY HOSPITAL	LONG TERM MILITARY HOSPITAL	HEADQUARTERS	SIGNAL STATIONS	MILITARY SHIPYARD	MILITARY FOUNDRY	MILITARY RAILROAD DEPOT	MILITARY HISTORIC PETROGLYPH	MILITARY SALTPETER MINE	NON-MILITARY COMPONENTS (S)
BEDFORD COUNTY																									
40BD71	U/C* NONE	X	-	-	-	-	-	-	X	-	X	-	-	-	X	-	-	-	-	-	-	-	-	-	-
40BD143	C NONE	X	X	-	-	-	-	-	-	-	-	-	-	-	-	-	-	-	-	-	-	-	-	-	-
40BD144	U NONE	-	-	-	-	-	-	-	X	-	X	-	-	-	-	-	-	-	-	-	-	-	-	-	-
40BD145	U NONE	X	X	-	-	-	-	-	X	-	X	-	-	-	X	-	-	-	-	-	-	-	-	-	-
40BD146	C NONE	X	-	-	-	-	-	-	-	-	-	-	-	-	-	-	-	-	-	-	-	-	-	-	-
40BD147	C NONE	X	-	-	-	X	-	-	-	-	-	-	-	-	-	-	-	-	-	-	-	-	-	-	-
40BD148	C NONE	X	-	-	-	-	-	-	-	-	-	-	-	-	-	-	-	-	-	-	-	-	-	-	-
40BD149	C NONE	X	-	-	-	-	-	-	-	-	-	-	-	-	-	-	-	-	-	-	-	-	-	-	-
40BD150	C NONE	X	-	-	-	-	-	-	-	-	-	-	-	-	-	-	-	-	-	-	-	-	-	-	-
40BD151	C NONE	X	-	-	-	-	-	-	-	-	-	-	-	-	-	-	-	-	-	-	-	-	-	-	-
40BD152	C NONE	X	-	-	-	-	-	-	-	-	-	-	-	-	-	-	-	-	-	-	-	-	-	-	-
40BD153	C NONE	X	-	-	-	-	-	-	-	-	-	-	-	-	-	-	-	-	-	-	-	-	-	-	-
40BD154	C NONE	X	-	X	-	-	-	-	-	-	-	-	-	-	-	-	-	-	-	-	-	-	-	-	-
40BD155	C NONE	X	-	-	-	-	-	-	-	-	-	-	-	-	X	-	-	-	-	-	-	-	-	-	-
40BD156	C NONE	-	-	-	-	-	-	-	-	-	-	-	-	-	X	-	-	-	-	-	-	-	-	-	-
40BD157	C NONE	X	-	-	-	-	-	-	-	-	-	-	-	-	X	-	-	-	-	-	-	-	-	-	-
40BD158	C NONE	-	-	-	-	-	-	-	-	-	-	-	-	-	X	-	-	-	-	-	-	-	-	-	-
CHEATHAM COUNTY																									
40CH153	U NONE	X	-	-	-	-	-	-	X	-	X	-	-	-	X	-	-	-	-	-	-	-	-	-	-
40CH154	U NONE	-	-	-	-	-	-	-	X	-	X	-	-	-	X	-	-	-	-	-	-	-	-	-	-
40CH155	U NONE	-	-	-	-	-	-	-	X	-	-	-	-	-	X	-	-	-	-	-	-	-	-	-	-
40CH156	U NONE	-	-	-	-	-	-	-	X	-	-	-	-	-	X	-	-	-	-	-	-	-	-	-	-
40CH157	U NONE	-	X	-	-	-	-	-	X	-	-	-	-	-	X	-	-	-	-	-	-	-	-	-	-
COFFEE COUNTY																									
40CF212	U OLD STOCKADE	-	-	-	-	-	-	-	X	X	-	-	-	-	-	-	-	-	-	-	-	-	-	-	-
40CF225	C NONE	X	-	-	-	-	-	-	-	-	-	-	-	-	X	-	-	-	-	-	-	-	-	-	-
40CF226	C NONE	X	-	-	-	-	-	-	-	-	-	-	-	-	-	-	-	-	-	-	-	-	-	-	-
40CF227	C BAILETTE HOUSE	-	-	-	-	-	-	-	-	-	-	-	-	-	-	X	-	-	-	-	-	-	-	-	-

TABLE 1 (continued)

SITE NO.	PRIMARY HISTORIC NAME	ENTRENCHMENT	REDOUBT	REDAN	LUNETTE	PRIEST CAP	EARTHWORK (UNDETERMINED)	FORT	RAILROAD GUARD POST	STOCKADE	BLOCKHOUSE	BATTLEFIELD--SMALL ENGAGEMENT	BATTLEFIELD--LARGE ENGAGEMENT	SHORT TERM ENCAMPMENT	LONG TERM ENCAMPMENT	SHORT TERM MILITARY HOSPITAL	LONG TERM MILITARY HOSPITAL	HEADQUARTERS	SIGNAL STATIONS	MILITARY SHIPYARD	MILITARY FOUNDRY	MILITARY RAILROAD DEPOT	MILITARY HISTORIC PETROGLYPH	MILITARY SALTPETER MINE	NON-MILITARY COMPONENTS(S)
COFFEE COUNTY (continued)																									
40CF228	C NONE	-	-	-	-	-	-	-	-	-	-	-	-	-	X	-	-	-	-	-	-	-	-	-	-
40CF229	C NONE	-	-	-	-	-	-	-	-	-	-	-	-	-	X	-	-	-	-	-	-	-	-	-	-
40CF230	C NONE	-	X	-	-	-	-	-	-	-	-	-	-	-	-	-	-	-	-	-	-	-	-	-	-
40CF231	U NONE	-	-	-	-	-	-	-	-	-	-	-	-	-	X	-	-	-	-	-	-	-	-	-	-
DAVIDSON COUNTY																									
40DV11	C TRAVELLER'S REST	-	-	-	-	-	-	-	-	-	-	-	-	X	-	-	-	X	-	-	-	-	-	-	X
40DV59	U SUNNYSIDE	-	-	-	-	-	-	-	-	-	-	-	X	-	-	X	-	-	-	-	-	-	-	-	X
40DV61	C NONE	X	-	-	-	-	-	-	-	-	-	-	X	X	-	-	-	-	-	-	-	-	-	-	-
40DV189	U FORT NEGLEY	-	-	-	-	-	-	X	-	-	-	-	-	-	-	-	-	-	-	-	-	-	-	-	-
40DV369	U 1ST PRESBYTERIAN CHURCH	-	-	-	-	-	-	-	-	-	-	-	-	-	-	-	X	-	-	-	-	-	-	-	X
40DV370	U NONE	-	-	-	-	-	-	-	-	-	-	-	-	-	X	-	-	-	-	X	-	-	-	-	-
40DV371	U NONE	-	-	-	-	-	-	-	-	-	-	-	-	-	-	-	X	-	-	-	-	-	-	-	X
40DV372	U NONE	-	-	-	-	-	-	-	X	-	-	-	-	-	-	-	-	-	-	-	-	-	-	-	X
40DV373	U ACKLEN MANSION	-	-	-	-	-	-	-	-	-	-	-	-	-	-	-	-	X	-	-	-	-	-	-	X
40DV374	U NONE	X	-	-	-	-	-	-	-	-	-	-	-	-	-	-	-	-	-	-	-	-	-	-	X
40DV375	U MORRIS AND STRATTON BLDG.	-	-	-	-	-	-	-	-	-	-	-	-	-	-	-	X	-	-	-	-	-	-	-	X
40DV376	U ELM STREET METHODIST CHURCH	-	-	-	-	-	-	-	-	-	-	-	-	-	-	-	X	-	-	-	-	-	-	-	X
40DV377	U WILLIAM STOCKELL'S SHOP	-	-	-	-	-	-	-	-	-	-	-	-	-	-	-	X	-	-	-	-	-	-	-	X
40DV378	U PRIMITIVE BAPTIST CHURCH	-	-	-	-	-	-	-	-	-	-	-	-	-	-	-	X	-	-	-	-	-	-	-	X
40DV379	U NONE	X	-	-	-	-	-	-	-	-	-	-	X	-	-	-	-	-	-	-	-	-	-	-	-
40DV380	? NONE	-	-	-	-	-	X	-	-	-	-	-	-	-	-	-	-	-	-	-	-	-	-	-	-
40DV381	C BRENNAN FOUNDRY	-	-	-	-	-	-	-	-	-	-	-	-	-	-	-	-	-	-	-	X	-	-	-	-
40DV382	C SHY'S HILL	X	-	-	-	-	-	-	-	-	-	-	X	-	-	-	-	-	-	-	-	-	-	-	-
40DV383	C NONE	X	-	-	-	-	-	-	-	-	-	-	X	-	-	-	-	-	-	-	-	-	-	-	-
40DV384	C REDOUBT #1	X	-	-	-	-	-	-	-	-	-	-	X	-	-	-	-	-	-	-	-	-	-	-	-
40DV385	C NONE	X	-	-	-	-	-	-	-	-	-	-	X	-	-	-	-	-	-	-	-	-	-	-	-
40DV386	C REDOUBT #2	X	-	-	-	-	-	-	-	-	-	-	X	-	-	-	-	-	-	-	-	-	-	-	-
40DV387	C REDOUBT #3	X	-	-	-	-	-	-	-	-	-	-	X	-	-	-	-	-	-	-	-	-	-	-	-
40DV388	C REDOUBT #4	X	-	-	-	-	-	-	-	-	-	-	X	-	-	-	-	-	-	-	-	-	-	-	-
40DV389	C REDOUBT #5	-	-	-	-	-	X	-	-	-	-	-	-	-	-	-	-	-	-	-	-	-	-	-	-
40DV390	U NONE	X	-	-	-	-	-	-	-	-	-	-	-	-	-	-	-	-	-	-	-	-	-	-	-
40DV391	C NONE	X	-	-	-	-	-	-	-	-	-	-	X	-	-	-	-	-	-	-	-	-	-	-	-
40DV392	C NONE	X	-	-	-	-	-	-	-	-	-	-	X	-	-	-	-	-	-	-	-	-	-	-	-
40DV393	U NONE	-	-	-	-	-	-	X	-	X	X	-	-	-	-	-	-	-	-	-	-	-	-	-	-

TABLE 1 (continued)

SITE NO.		PRIMARY HISTORIC NAME	ENTRENCHMENT	REDOUBT	REDAN	LUNETTE	PRIEST CAP	EARTHWORK (UNDETERMINED)	FORT	RAILROAD GUARD POST	STOCKADE	BLOCKHOUSE	BATTLEFIELD-SMALL ENGAGEMENT	BATTLEFIELD-LARGE ENGAGEMENT	SHORT TERM ENCAMPMENT	LONG TERM ENCAMPMENT	SHORT TERM MILITARY HOSPITAL	LONG TERM MILITARY HOSPITAL	HEADQUARTERS	SIGNAL STATIONS	MILITARY SHIPYARD	MILITARY FOUNDRY	MILITARY RAILROAD DEPOT	MILITARY HISTORIC PETROGLYPH	MILITARY SALTPETER MINE	NON-MILITARY COMPONENTS (S)	
HUMPHREYS COUNTY																											
40HS157	U	JOHNSONVILLE	-	2	-	-	-	-	-	-	-	-	X	-	-	X	-	-	-	-	-	-	-	-	-	-	X
40HS177	U	NONE	X	-	-	-	-	-	-	X	-	2	-	-	-	-	-	-	-	-	-	-	-	-	-	-	-
40HS178	U	NONE	-	X	-	-	-	-	-	X	-	-	-	-	-	-	-	-	-	-	-	-	-	-	-	-	-
40HS179	U	NONE	-	-	-	-	-	X	-	X	-	-	-	-	-	-	-	-	-	-	-	-	-	-	-	-	-
40HS180	U	FORT HILL	-	X	-	-	-	-	-	-	-	-	-	-	-	-	-	-	-	-	-	-	-	-	-	-	-
MAURY COUNTY																											
40MU510	C	NONE	-	-	-	X	-	-	-	-	-	-	-	-	-	-	-	-	-	-	-	-	-	-	-	-	-
40MU511	C	NONE	X	-	-	-	-	-	-	-	-	-	-	-	-	-	-	-	-	-	-	-	-	-	-	-	-
40MU512	U	NONE	X	-	-	-	-	-	-	-	-	-	X	-	-	-	-	-	-	-	-	-	-	-	-	-	-
40MU513	U	NONE	X	-	-	-	-	-	-	-	-	-	-	-	-	-	-	-	-	-	-	-	-	-	-	-	-
40MU514	U	NONE	-	-	-	-	-	-	X	-	-	-	X	-	-	-	-	-	-	-	-	-	-	-	-	-	-
40MU515	U	NONE	-	-	-	-	-	-	-	X	-	X	-	-	-	-	-	-	-	-	-	-	-	-	-	-	-
40MU516	U	NONE	-	-	-	-	-	-	-	X	-	X	X	-	-	-	-	-	-	-	-	-	-	-	-	-	-
40MU517	C	OAKLAWN	-	-	-	-	-	-	-	-	-	-	-	-	X	-	-	X	-	-	-	-	-	-	-	-	X
MONTGOMERY COUNTY																											
40MT287	U/C	FORT DEFIANCE	-	-	-	-	-	-	X	-	-	-	-	-	-	-	-	-	-	-	-	-	-	-	-	-	-
ROBERTSON COUNTY																											
40RB81	U/C	NONE	X	-	-	-	-	-	-	X	-	X	-	-	-	-	-	-	-	-	-	-	-	-	-	-	-
RUTHERFORD COUNTY																											
40RD176	U	REDOUBT BRANNON	-	X	-	-	-	-	X	-	-	-	-	-	-	-	-	-	-	-	-	-	-	-	-	-	-
40RD177	U	NONE	X	-	-	-	-	-	-	-	-	-	-	X	-	-	-	-	-	-	-	-	-	-	-	-	-
40RD178	C/U	NONE	-	-	-	-	-	-	-	-	-	-	-	-	-	X	-	-	-	-	-	-	-	-	-	-	-
40RD179	U	NONE	-	-	-	-	-	-	-	-	-	-	-	-	X	-	-	-	-	-	-	-	-	-	-	-	-
40RD180	C/U	BLANTON HOUSE	-	-	-	-	-	-	-	-	-	-	-	-	-	-	X	-	-	-	-	-	-	-	-	-	X
40RD181	U	HORD HOUSE	-	-	-	-	-	-	-	-	-	-	-	-	-	-	X	-	-	-	-	-	-	-	-	-	X
40RD182	C	NONE	X	-	-	-	-	-	-	-	-	-	-	-	-	-	-	-	-	-	-	-	-	-	-	-	-
40RD183	C	NONE	-	-	-	-	-	X	-	-	-	-	-	-	-	-	-	-	-	-	-	-	-	-	-	-	-
40RD184	U	NONE	-	-	-	-	-	-	-	-	-	-	-	-	-	-	-	-	-	-	-	-	X	-	-	-	-
40RD185	?	NONE	X	-	-	-	-	-	-	-	-	-	-	-	-	-	-	-	-	-	-	-	-	-	-	-	-
40RD186	U	NONE	-	-	-	-	-	-	-	-	-	-	-	-	-	-	-	-	-	X	-	-	-	-	-	-	-
40RD187	U	NONE	-	-	-	-	-	-	-	-	-	X	-	-	-	-	-	-	-	X	-	-	-	-	-	-	-

TABLE 1 (continued)

SITE NO.	PRIMARY HISTORIC NAME	ENTRENCHMENT	REDOUBT	REDAN	LUNETTE	PRIEST CAP	EARTHWORK (UNDETERMINED)	FORT	RAILROAD GUARD POST	STOCKADE	BLOCKHOUSE	BATTLEFIELD-SMALL ENGAGEMENT	BATTLEFIELD-LARGE ENGAGEMENT	SHORT TERM ENCAMPMENT	LONG TERM ENCAMPMENT	SHORT TERM MILITARY HOSPITAL	LONG TERM MILITARY HOSPITAL	HEADQUARTERS	SIGNAL STATIONS	MILITARY SHIPYARD	MILITARY FOUNDRY	MILITARY RAILROAD DEPOT	MILITARY HISTORIC PETROGLYPH	MILITARY SALTPETER MINE	NON-MILITARY COMPONENTS (S)
RUTHERFORD COUNTY (continued)																									
40RD188	U NONE	-	-	-	-	-	-	-	X	-	X	-	-	-	-	-	-	-	-	-	-	-	-	-	-
40RD189	U NONE	-	-	-	-	-	-	-	X	-	X	-	-	-	-	-	-	-	-	-	-	-	-	-	-
40RD190	U NONE	-	-	-	-	-	-	-	-	-	X	-	-	-	-	-	-	-	-	-	-	-	-	-	-
40RD191	U NONE	-	-	-	-	-	-	-	X	-	X	-	-	-	-	-	-	-	-	-	-	-	-	-	-
40RD192	U NONE	-	X	-	-	-	-	-	-	-	-	-	-	-	X	-	-	-	-	-	-	-	-	-	-
40RD193	U LUNETTES THOMAS & PALMER	X	-	-	2	-	-	X	-	-	-	-	-	-	-	-	-	-	-	-	-	-	-	-	-
40RD194	U NONE	X	-	-	-	-	-	-	X	-	X	-	-	-	-	-	-	-	-	-	-	-	-	-	-
40RD195	U/C THE CORNERS	-	-	-	-	-	-	-	-	-	-	-	-	-	-	-	X	-	-	-	-	-	-	-	X
SMITH COUNTY																									
40SM134	U BATTERY KNOB	X	-	-	-	-	-	-	-	-	-	-	-	-	-	-	-	-	-	-	-	-	-	-	-
STEWART COUNTY																									
40SW190	C FORT DONELSON	X	-	-	-	-	-	X	-	-	-	X	-	-	X	-	-	-	-	-	-	-	-	-	-
40SW221	C FORT HENRY	X	-	-	-	-	-	X	-	-	-	X	-	-	X	-	-	-	-	-	-	-	-	-	-
40SW222	U NONE	-	-	-	-	-	X	-	-	-	-	-	-	X	-	-	-	-	-	-	-	-	-	-	-
SUMNER COUNTY																									
40SU103	U NONE	-	X	-	-	-	-	-	X	-	-	X	-	-	-	-	-	-	-	-	-	-	-	-	-
40SU104	U NONE	-	X	-	-	-	-	-	X	-	-	-	-	-	-	-	-	-	-	-	-	-	-	-	-
40SU105	U NONE	-	-	-	-	-	X	-	X	-	-	-	-	-	-	-	-	-	-	-	-	-	-	-	-
40SU106	U FORT SMITH	-	-	-	-	-	-	X	X	-	-	-	-	-	X	-	-	-	-	-	-	-	-	-	-
40SU107	C CAMP TROUSDALE	-	-	-	-	-	-	-	-	-	-	-	-	-	X	-	-	-	-	-	-	-	-	-	-
40SU108	U NONE	-	-	-	-	-	X	-	-	-	-	-	-	-	X	-	-	-	-	-	-	-	-	-	-
VAN BUREN COUNTY																									
40VB103	U/C BONE CAVE	-	-	-	-	-	-	-	-	-	-	-	-	-	-	-	-	-	-	-	-	-	-	X	-
WARREN COUNTY																									
40WR34	U NONE	-	-	-	-	-	-	-	X	-	-	X	-	-	-	-	-	-	-	-	-	-	-	-	-
WILLIAMSON COUNTY																									
40WM92	C CARNTON	-	-	-	-	-	-	-	-	-	-	-	-	-	-	X	-	-	-	-	-	-	-	-	X
40WM100	U FORT GRANGER	X	-	-	-	-	-	X	-	-	-	-	-	-	X	-	-	-	-	-	-	-	-	-	-
40WM101	U ROPER'S KNOB	-	X	-	-	-	-	-	-	-	X	-	-	-	X	-	-	-	-	-	-	-	-	-	-

TABLE 1 (continued)

SITE NO.	PRIMARY HISTORIC NAME	ENTRENCHMENT	REDOUBT	REDAN	LUNETTE	PRIEST CAP	EARTHWORK (UNDETERMINED)	FORT	RAILROAD GUARD POST	STOCKADE	BLOCKHOUSE	BATTLEFIELD-SMALL ENGAGEMENT	BATTLEFIELD-LARGE ENGAGEMENT	SHORT TERM ENCAMPMENT	LONG TERM ENCAMPMENT	SHORT TERM MILITARY HOSPITAL	LONG TERM MILITARY HOSPITAL	HEADQUARTERS	SIGNAL STATIONS	MILITARY SHIPYARD	MILITARY FOUNDRY	MILITARY RAILROAD DEPOT	MILITARY HISTORIC PETROGLYPH	MILITARY SALTPETER MINE	NON-MILITARY COMPONENTS (S)
WILLIAMSON COUNTY (continued)																									
40WM102	U NONE	-	-	-	X	-	-	-	-	-	-	-	-	-	X	-	-	-	-	-	-	-	-	-	-
40WM103	U NONE	-	-	X	-	-	-	-	-	-	-	-	-	-	-	-	-	-	-	-	-	-	-	-	-
40WM104	U NONE	-	-	-	X	-	-	-	-	-	-	-	-	-	-	-	-	-	-	-	-	-	-	-	-
40WM105	U NONE	X	-	-	-	-	-	-	-	-	-	-	-	-	-	-	-	-	-	-	-	-	-	-	-
40WM106	U NONE	X	2	-	-	-	-	X	-	-	-	-	-	-	X	-	-	-	-	-	-	-	-	-	-
40WM107	U NONE	X	-	-	-	-	-	-	-	-	-	-	-	-	-	-	-	-	-	-	-	-	-	-	-
40WM108	U CARTER HOUSE	X	-	-	-	-	-	-	-	-	-	-	X	-	-	X	-	X	-	-	-	-	-	-	X
40WM120	U/C MASONIC HALL	-	-	-	-	-	-	-	-	-	-	-	-	-	-	X	-	-	-	-	-	-	-	-	X
40WM121	U/C WILLIAMSON CTY COURTHOUSE	-	-	-	-	-	-	-	-	-	-	-	-	-	-	X	-	-	-	-	-	-	-	-	X
40WM122	C H.P. FIGURES HOUSE	-	-	-	-	-	-	-	-	-	-	-	-	-	-	X	-	-	-	-	-	-	-	-	X
40WM123	U/C ST. PAUL'S EPISCOPAL CHURCH	-	-	-	-	-	-	-	-	-	-	-	-	-	-	X	-	-	-	-	-	-	-	-	X
40WM124	U/C WILLIAMSON HARRISON HOUSE	-	-	-	-	-	-	-	-	-	-	-	-	-	-	X	-	X	-	-	-	-	-	-	X
TOTAL SITES: 143																									
TOTAL COMPONENTS:		59	20	3	5	1	7	10	37	2	25	14	14	4	32	10	7	6	2	1	1	1	1	1	24

*U=Union C=Confederate U/C=Union and Confederate

the 23 military component headings on Table 1 (24 of the sites on Table 1 also have one or more non-military components that are not Civil War related - last column).

The definitions for military components discussed below were derived primarily by reference to nineteenth-century military manuals by Mahan (1836) and Scott (1864) and from the more recent definitions of David Wright (1982).

Earthworks:

Entrenchment

In its simplest form this kind of defensive work (sometimes referred to as a breastwork) consists of at least a ditch and parapet. During the Civil War, such works were often hastily constructed under battle conditions using a variety of available digging implements, and in some cases locally available materials such as stone or logs were incorporated into the parapet. The inner face of the parapet was sometimes built against a revetment, often composed of vertical posts supporting horizontal wooden members. With additional time available more elaborate entrenchments could be constructed to include such additional features as headlogs, an outer ditch, palisades, advanced rifle pits, and abatis (Fig. 3). The technical terminology for entrenchments is explained in Figure 4. Remains of entrenchments constitute the largest category recorded during the Middle Tennessee survey. Some examples of entrenchments in use or undergoing construction are shown in Figure 5. The Middle Tennessee examples that were recorded range from ones with ditches and embankments that are still well defined to ones that have been flattened and nearly obliterated by cultivation or other adverse impacts. Some Middle Tennessee towns that were fortified during the conflicts that occurred, especially in 1863, still retain long segments of well preserved entrenchment lines.

Redoubt

This term applies to an earthwork that is enclosed on all sides. The overall configuration may be square, polygonal, or circular (Fig. 6). The Middle Tennessee redoubts were often relatively small detached works used to fortify hilltops or strengthen main lines.

Redan

A V-shaped earthwork (Fig. 6), open at the rear (the opening being referred to as the gorge). The few Middle Tennessee examples found occur both as detached works and as portions of defensive lines.

Lunette

An earthwork that is similar to a Redan, but with the addition of two flanks (Fig. 6). Its usage in Middle Tennessee appears to have been similar to that of the Redans.

Priest Cap

The overall form of this type of earthwork resembles a capital "M" (Fig. 6). It was similar in usage and function to a redan. Only one example was found in Middle Tennessee.

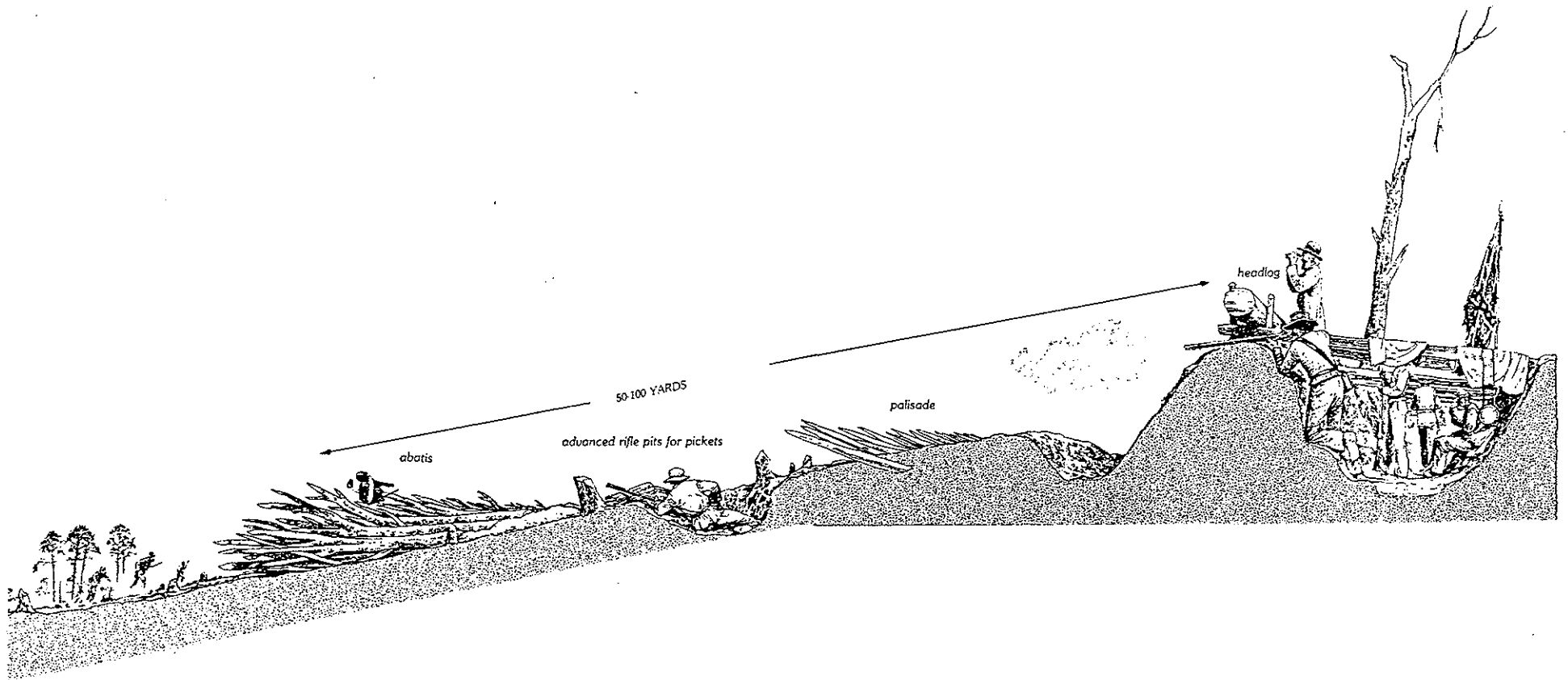
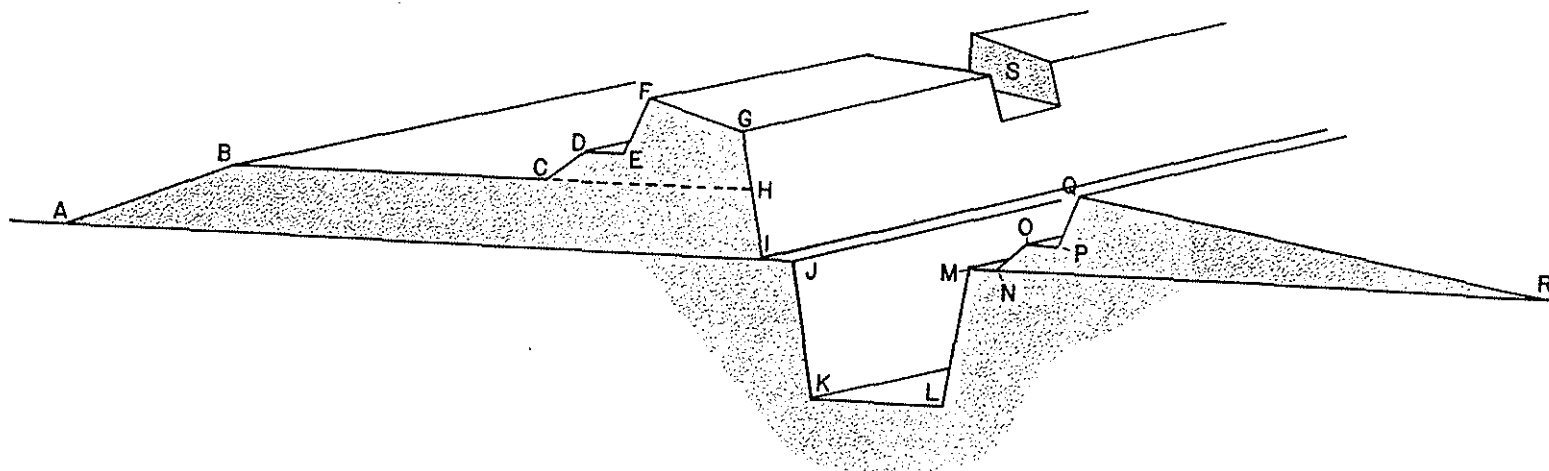

Figure 3. Cross sectional diagram of an entrenchment with various kinds of associated defensive features (from Griffith 1986: 34-35).



ABHI - Rampart or Bulwark
 CDEFGH - Parapet
 JKLM - Ditch
 NOPQR - Glacis
 AB - Parade or Slope
 BC - Terreplein
 CD - Banquette Slope
 DE - Tread of the Banquette
 or simply Banquette
 EF - Interior Slope
 FG - Superior Slope
 GI - Exterior Slope
 (if no Rampart, GH)
 IJ - Berm
 JK - Scarp Wall
 KL - Bottom of the Ditch
 LM - Counterscarp Wall
 MN - Coverd Way
 NO - Glacis Banquette Slope

OP - Banquette
 PQ - Interior Slope
 QR - Glacis Slope
 S - Embrasure
 High points or Crest:
 F - Interior Crest
 G - Exterior Crest
 J - Scarp Crest
 M - Counterscarp
 Q - Glacis Crest
 Low pints or Foot:
 C - Foot of Banquette Slope
 E - Foot of Interior Slope
 I - Foot of exterior Slope
 (if no Rampart, H)
 K - Foot of Scarp
 L - Foot of Counterscarp
 R - Foot of Glacis

Figure 4. Entrenchment profile (adapted from Scott 1864: 284).

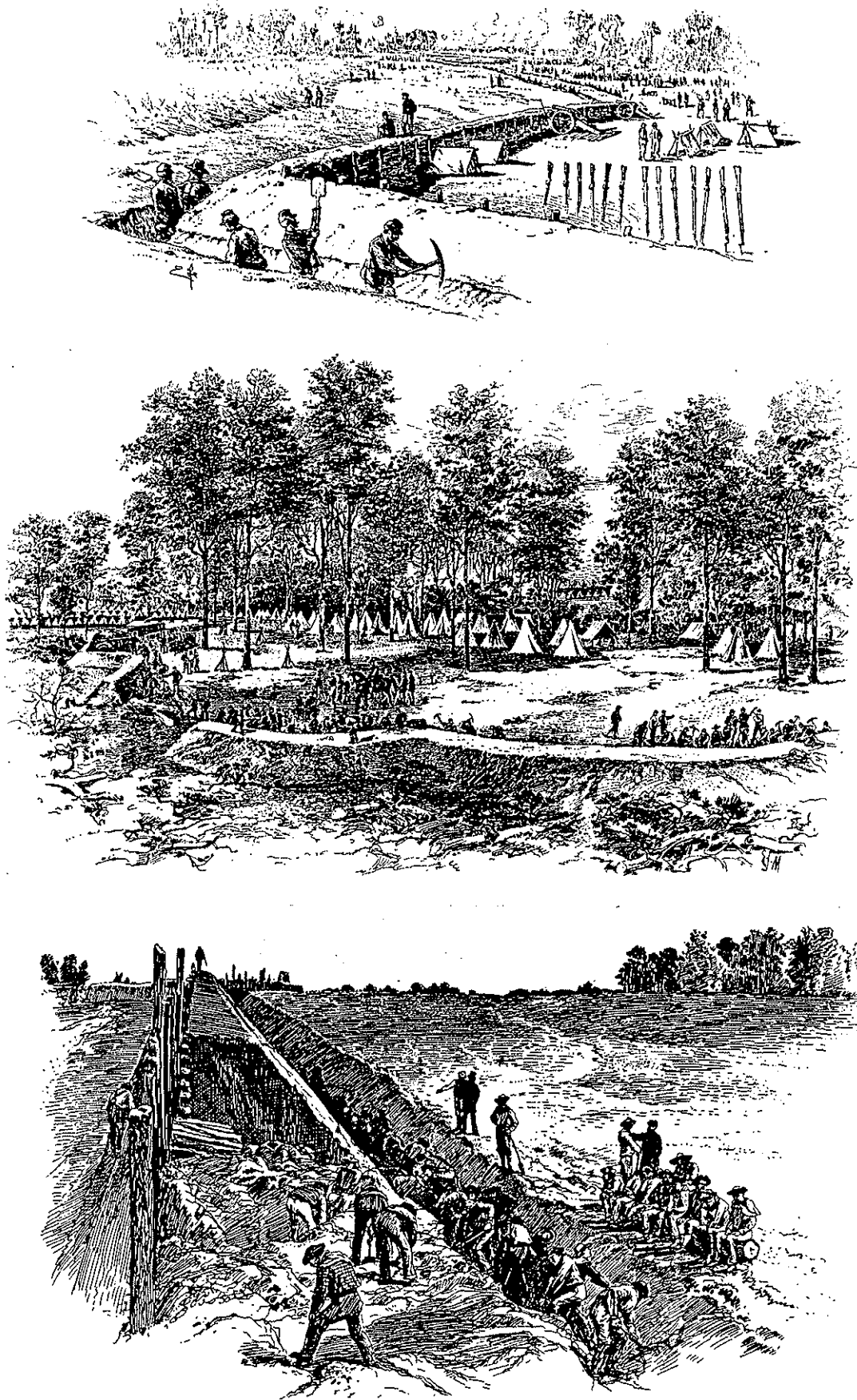
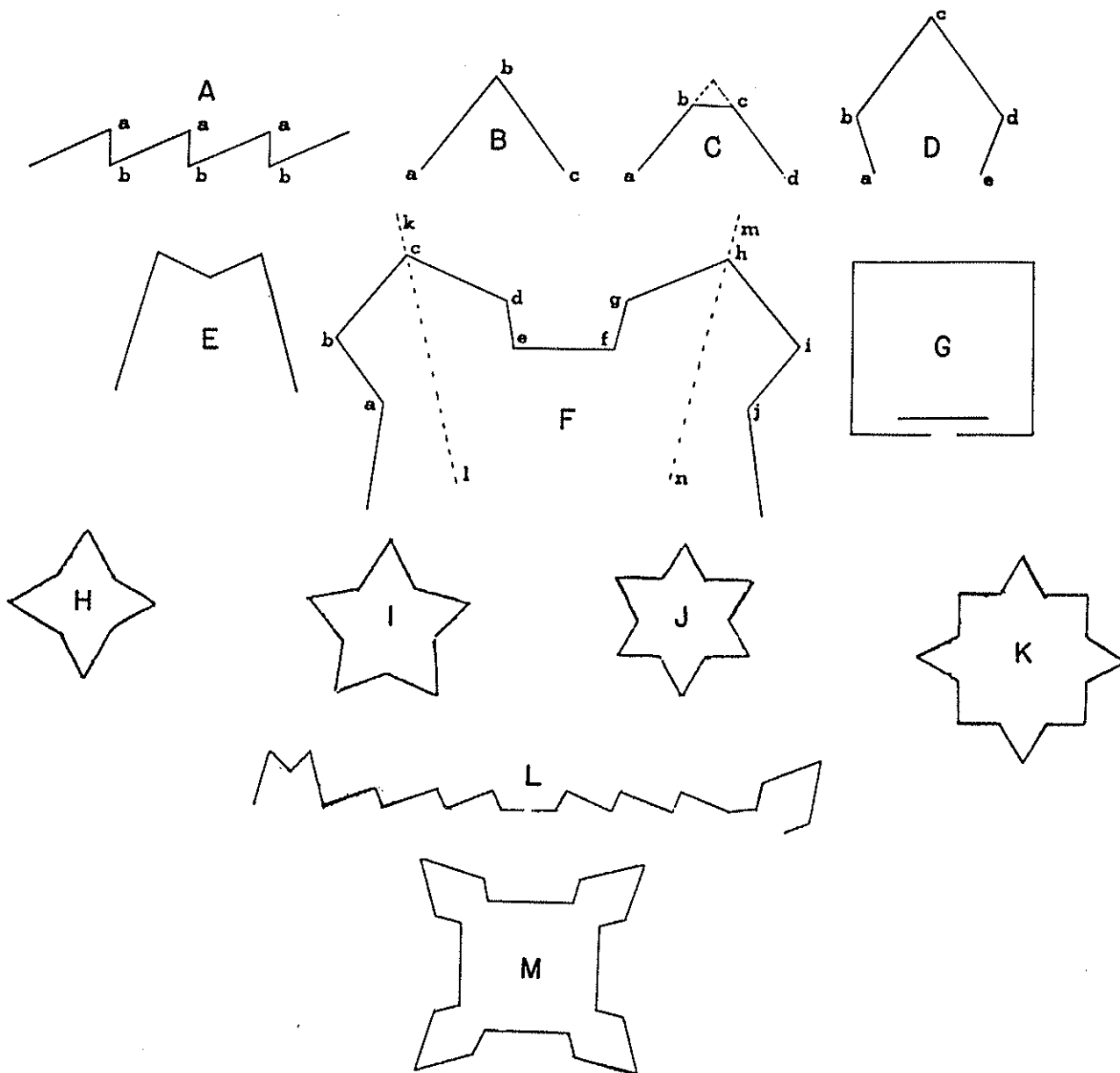

Figure 5. Entrenchment sketches (from Sears 1974; Johnson and Buel 1956).



- | | |
|--|---|
| <p>A Cremaillere or Indented Line
 a - Salients
 b - Re-Enterings</p> <p>B Redan
 ab - Face
 bc - Face
 ac - Gorge</p> <p>C Redan with Pan Coupe (bc)</p> <p>D Lunette
 bc, cd - Faces
 ab, de - Flanks</p> <p>E Priest Cap or Swallow Tail</p> | <p>F Bastioned Fort
 ef - curtain
 abcde - Lunette
 fghij - Lunette
 kl, mn - Capitals</p> <p>G Redoubt (in this case a Square)
 Traverse protects Outlet of Gorge</p> <p>H-K Forms of Star Forts</p> <p>L Plan of indented line between
 Priest-Cap and Lunette Salients</p> <p>M Plan of Bastion Fort drawn from
 a square</p> |
|--|---|

Figure 6. Fortification forms (adapted from Mahan 1836).

Earthwork (undetermined type)

This component category was used to account for what were usually small remaining segments of earthworks that were not sufficiently intact to determine their exact original form.

Other Fortifications:

Fort

As used here, this term applies to large enclosed earthworks, which were sometimes supported by outerworks such as lunettes and redans and inner works such as blockhouses. During the Civil War, the term fort was loosely applied to other important positions, especially isolated redoubts, but during the Middle Tennessee survey it was only used for the remains of 8 of the area's larger, enclosed works (because two remaining portions of Fortress Rosecrans were recorded as different sites, there are 9 fort components on Table 1). The basic configurations used in the construction of forts are illustrated in Figure 6. The 8 recorded examples are varied in the overall plans that were used. The 3 examples originally constructed by the Confederates (Forts Donelson, Henry, and Defiance) were designed to protect major river routes. Those built by the Federal troops were intended to protect major supply depots and transportation routes, including railroad lines. The largest of the Middle Tennessee forts was Fortress Rosecrans, but the most elaborate in design was Fort Negley (Fig. 7).

Railroad Guard Post

This refers to a fortification designed to protect a vulnerable point, such as a bridge or trestle, on a railroad. Such positions were often defended using stockades, blockhouses, and/or some type of earthwork. The most commonly used earthworks were redoubts and entrenchments. Only one or two of these posts were constructed by the Confederates. Early in the war the Federals relied primarily on stockades for defending such positions, but by 1864 the preferred form of defense was what was called a blockhouse (see below). Almost all of the railroad guard posts were manned by small detachments of troops who were usually quartered in permanent encampments adjacent to the defenses.

Stockade

During the Civil War the term stockade, which was derived from an earlier frontier use of this term, was applied to relatively simple enclosures that were usually square or cross-shaped in design. All of the known examples in Middle Tennessee were associated with railroad guard posts. These enclosures were constructed of vertical log walls, which contained loopholes for firing (Fig. 8). Some stockades had circular corner bastions that could accommodate tents for quartering troops (Fig. 9). Most stockades in Middle Tennessee were strengthened by an outer ditch, with the earth from this ditch being piled against the stockade wall. Figure 10 is a Civil War period photograph that shows a stockade during the construction of its outer ditch.

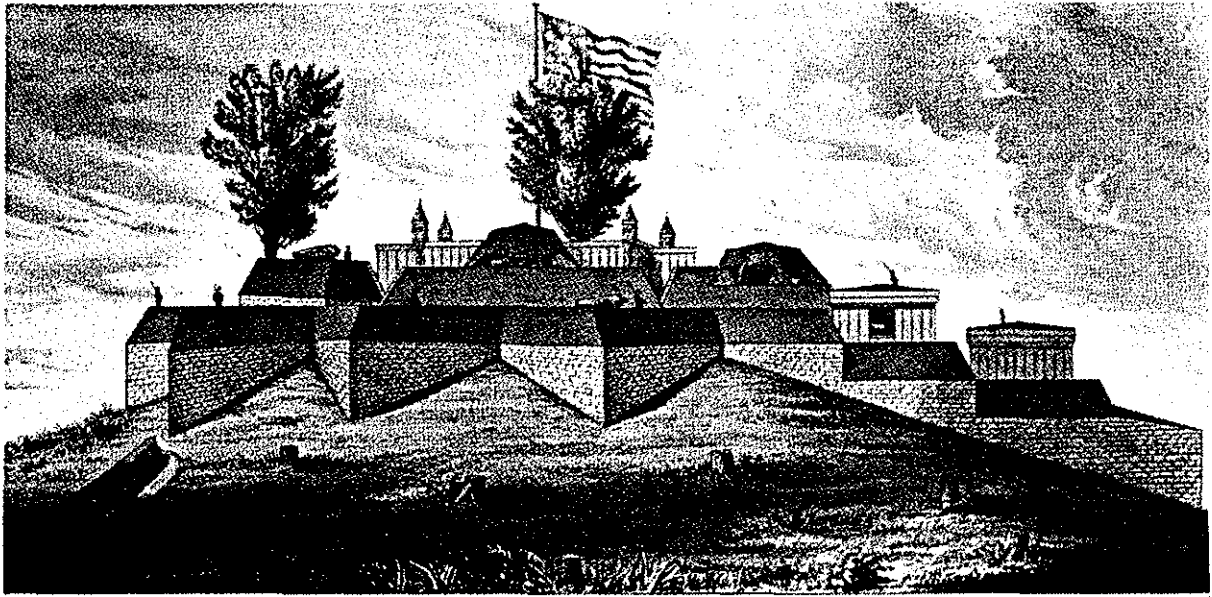

SOUTH WEST VIEW OF FORT NEGLEY.

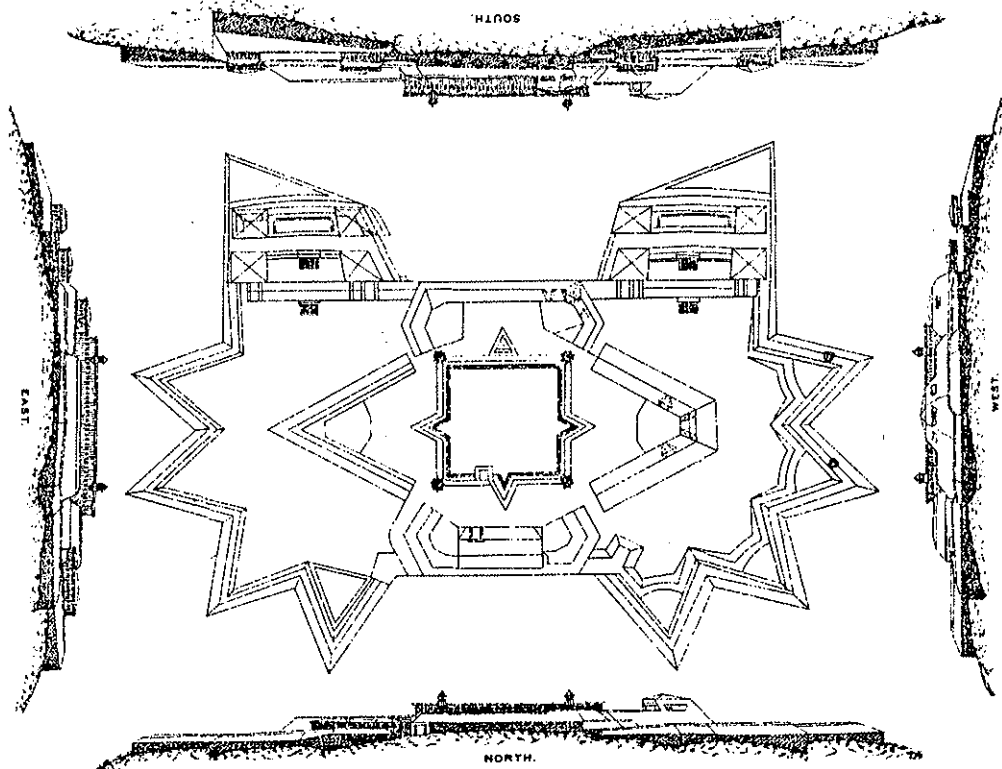

Figure 7. An 1864 drawing (upper) and plan (lower) of Fort Negley. Upper from Adams and Christian (n.d.: 39); lower from Davis et al. (1983, Plate 114, Map 3).

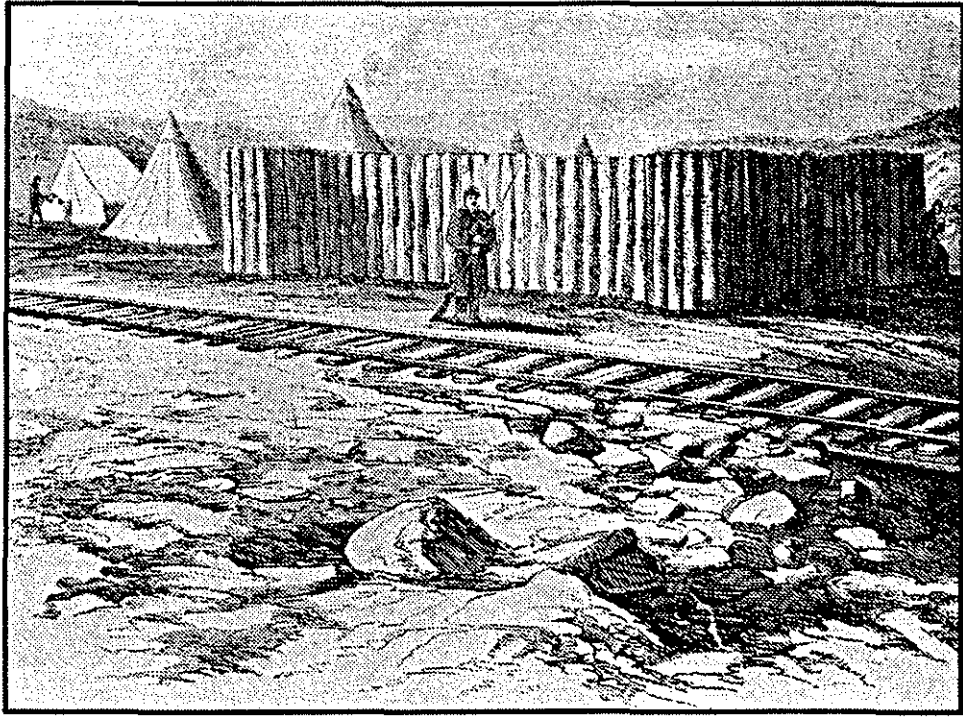

Figure 8. An 1863 view of Union stockade on the Louisville and Nashville Railroad. From Adams and Christian (n.d.: 36).

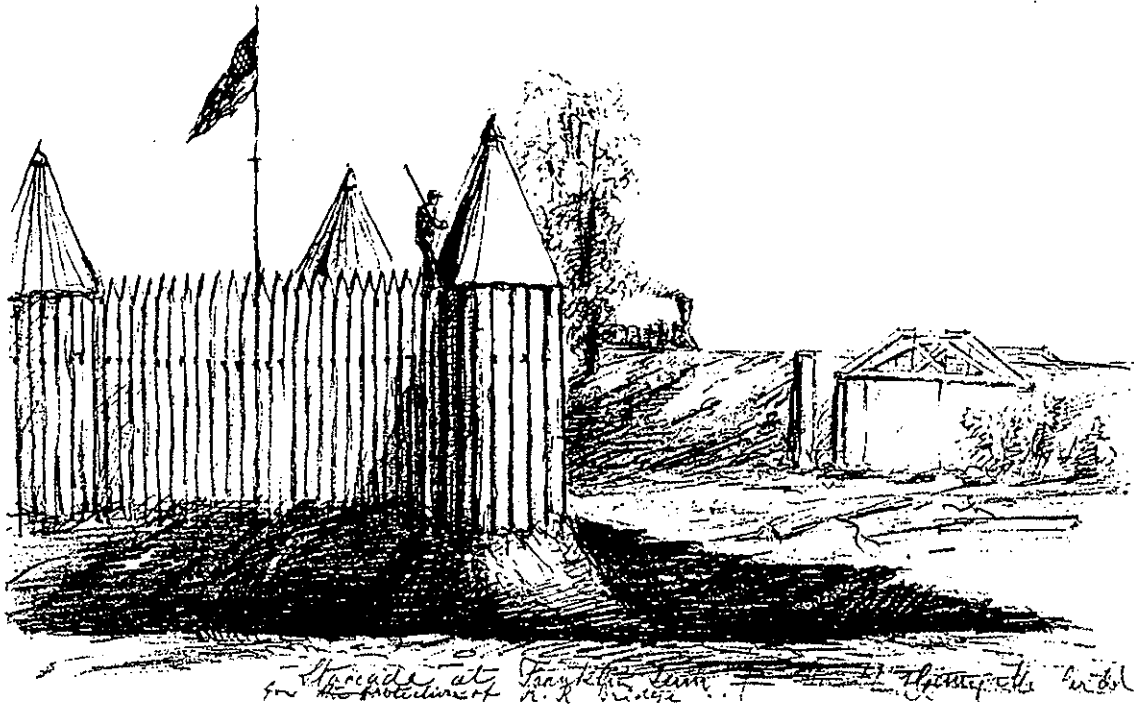

Figure 9. View of a Union stockade protecting a railroad bridge at Franklin, Tennessee. From Kelley (1989: 15).

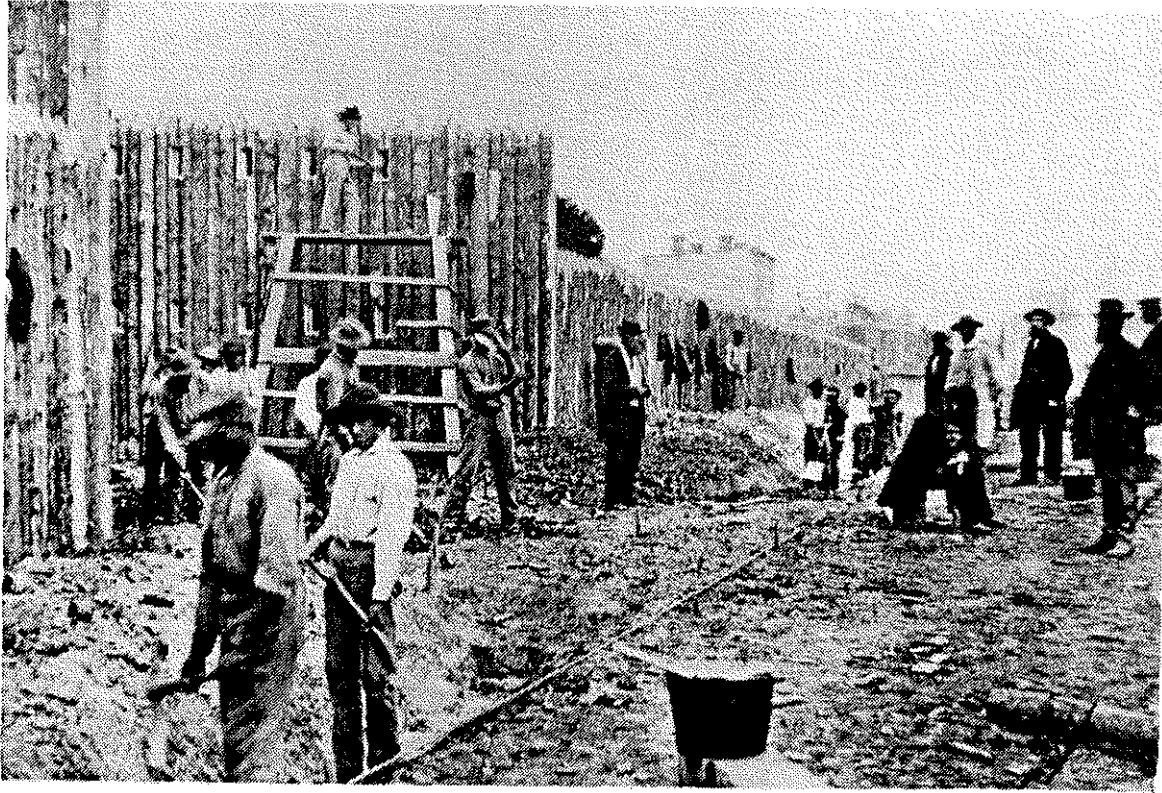

Figure 10. Early Civil War photograph from Miller (1911: Vol. 5, p. 91) showing men engaged in the construction of an elaborate stockade enclosure that was used to protect Union railroad facilities in the Washington-Alexandria area. The stockade wall being in place, the workers are engaged in the digging of an exterior ditch, using the dirt to form an embankment against the lower portion of the wall. Several stakes and a guide rope are in place to indicate the location of the excavation. A worker standing on a scaffold is cutting loopholes near the top of the stockade wall, indicating that there is a firing platform on its upper interior. This type of construction was used early in the Civil War for railroad defenses in the Middle Tennessee area.

Blockhouse

Like stockade, blockhouse was a term readapted for use during the Civil War to describe a defensive construction used primarily in connection with railroad guard posts. Some of the larger forts in Middle Tennessee had blockhouses within their enclosures, but as defined here the term relates primarily to railroad defense. This form of construction, which was considered a major improvement over the stockade in terms of defensive strength, was introduced in early 1864 by Colonel William E. Merrill, Chief Engineer for the Army of the Cumberland (Merrill 1875). Merrill created plans for several types of blockhouses, and the original drawings for at least three of these have survived (Figures 11, 12, and 13). Most of the Middle Tennessee blockhouses appear to have been constructed in accordance with the plans shown in Figures 11 and 12 (four examples of blockhouses built according to Merrill's standards are shown in Fig. 14 and Fig. 15). Figure 13 shows a blockhouse designed to house artillery; no example of this design is known to have existed in Middle Tennessee. The rather elaborate blockhouse shown in Figure 15 (lower) is very similar to a Middle Tennessee example that is illustrated in an 1860s drawing (Kelley 1989: 28). The primary characteristics of a blockhouse were that it was constructed with a core of heavy timbers (both vertical and horizontal timbers were used), with a surrounding ditch and earthen embankments against the blockhouse walls, and with a flat, timbered roof covered with dirt and capped with a sloping board and batten roof to shed water. The blockhouse walls contained loopholes just above the level of the embankment, and usually a single entrance, sometimes below ground level. As the war progressed the thickness of the blockhouse walls was doubled to enable them to withstand artillery fire. In many instances two or more blockhouses were used to guard the same trestle or bridge.

Battlefields:

Battlefield - Small Engagement

This refers to a minimum contest in which a relatively small number of troops were engaged. Many such engagements occurred in the Middle Tennessee area, but most of these had little strategic importance. More importantly, from the standpoint of the survey, these were activities that are unlikely to have left any meaningful archaeological evidence for their occurrence. No intentional effort was made to record Small Engagement Battlefields, and those components that are listed in Table 1 are incidental to the recording of sites with other activities.

Battlefield - Large Engagement

This refers to an engagement involving a large number of troops, usually at the corps or army level. Such conflicts were usually planned in advance. While 15 Large Engagement components are shown on Table 1, these actually refer to parts of only 3 battlefields (Murfreesboro, Franklin, and Nashville). These were the only engagements fought in Middle Tennessee that were on a large enough scale to warrant their inclusion under this heading.

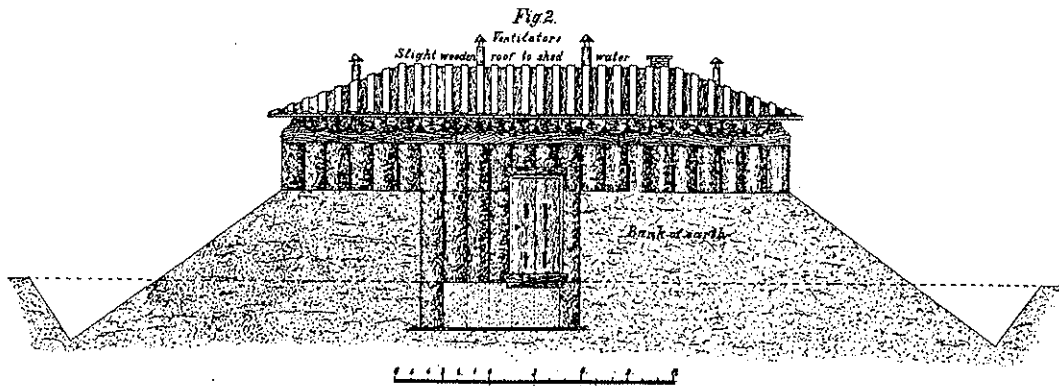

BLOCK HOUSE SKETCHES *Scale for Blockhouse 1=6'*
for practical use in the field
 by *Capt. W^c E. Merrill U.S. Engr.*
Chief Engr. Army Cumberland.

Sheet N^o 1.

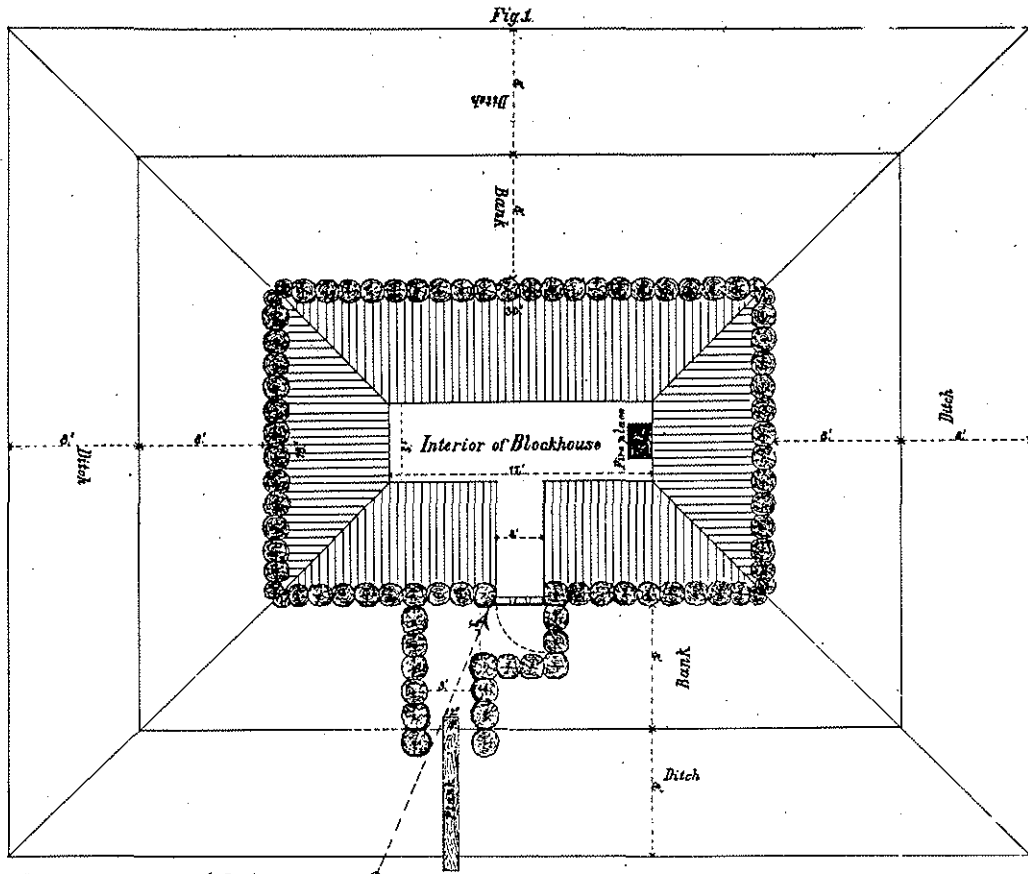
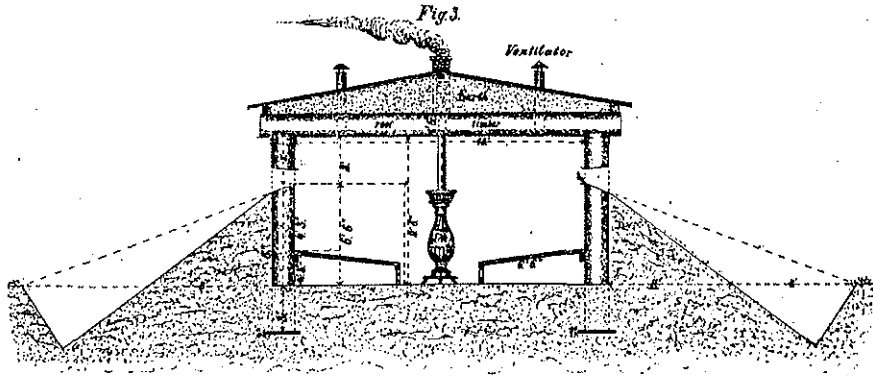

Blockhouse N^o 1.

Figure 11. Adapted from Blockhouse Sketch # 1 (2/1864) by Col. William E. Merrill (Buell-Brien Papers, Tn. State Library and Archives).

BLOCK-HOUSE SKETCHES

for practical use in the field,

by

Capt. W. E. Merrill, U. S. Engrs.

Chief Engr. Army Cumberland.

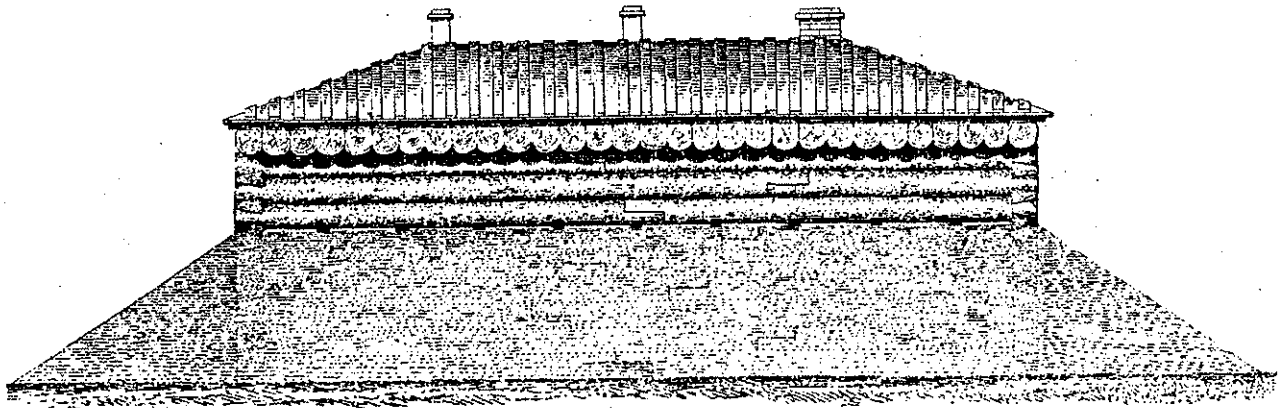

Side Elevation.

Sheet N^o 2.

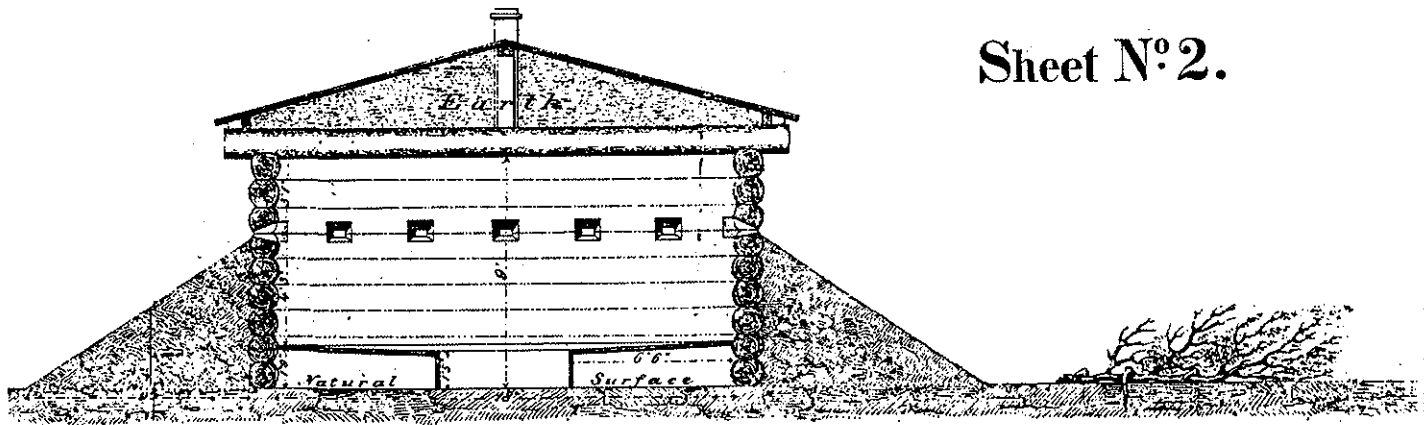

Transverse Section

Cellar.

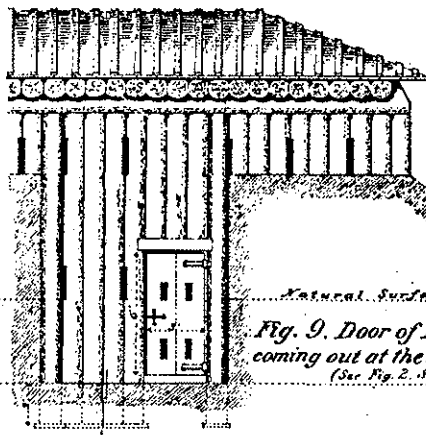

*Fig. 9. Door of Blockhouse,
coming out at the level of the ditch.
(See Fig. 2, Sheet. 8-1.)*

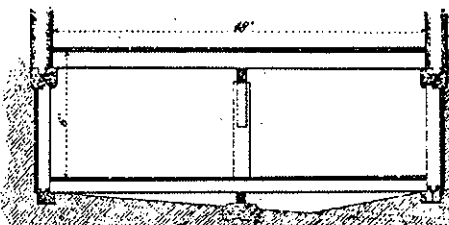

Fig. 10. Transverse Section.

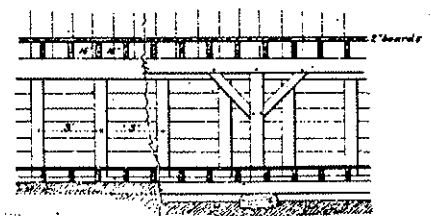

Fig. 11. Longitudinal Section.

In cellars liable to overflow, drain to a sink and bail out when necessary, if the soil of the bank will keep out of water, if not, drain outside and abandon the cellar during high water.

Figure 12. Adapted from Blockhouse Sketch # 2 (3/1864) by Col. William E. Merrill (Buell-Brien Papers, Tn. State Library and Archives).

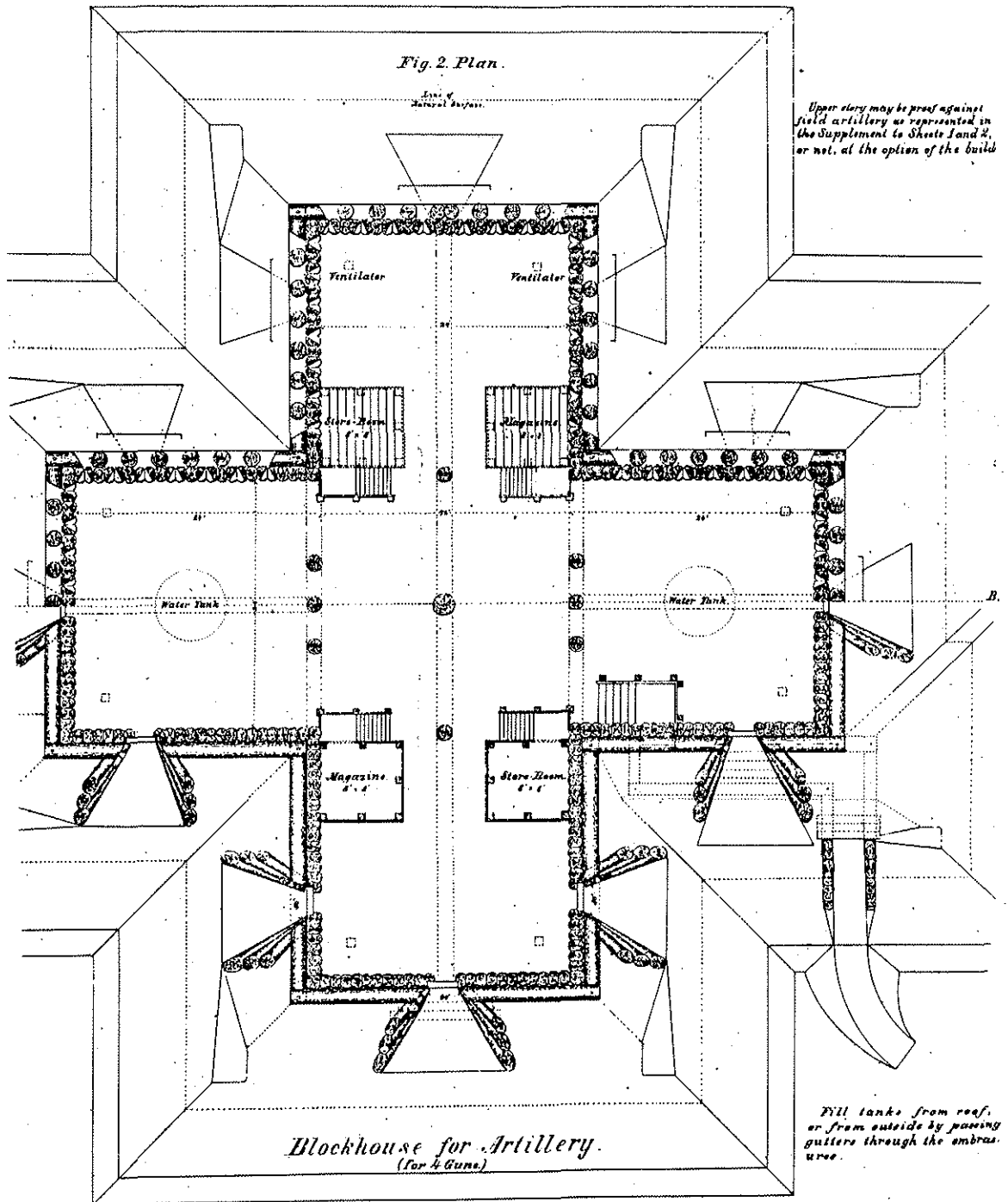
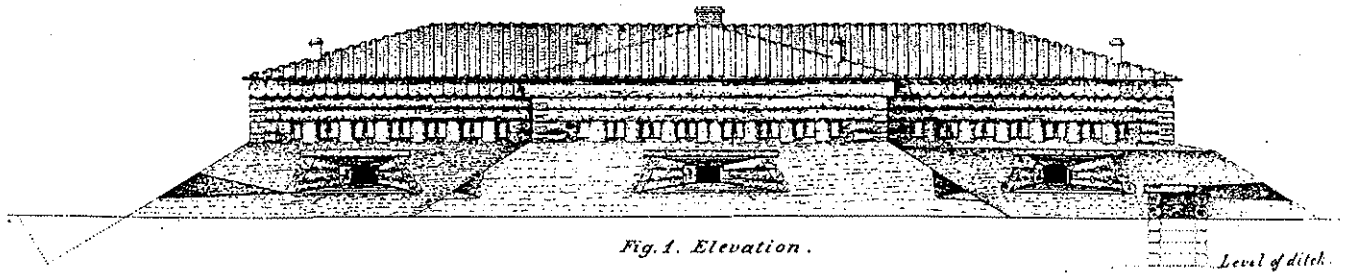

Figure 13. Adapted from Blockhouse Sketch # 3 (4/1864) by Col. William E. Merrill (Buell-Brien Papers, Tn. State Library and Archives).

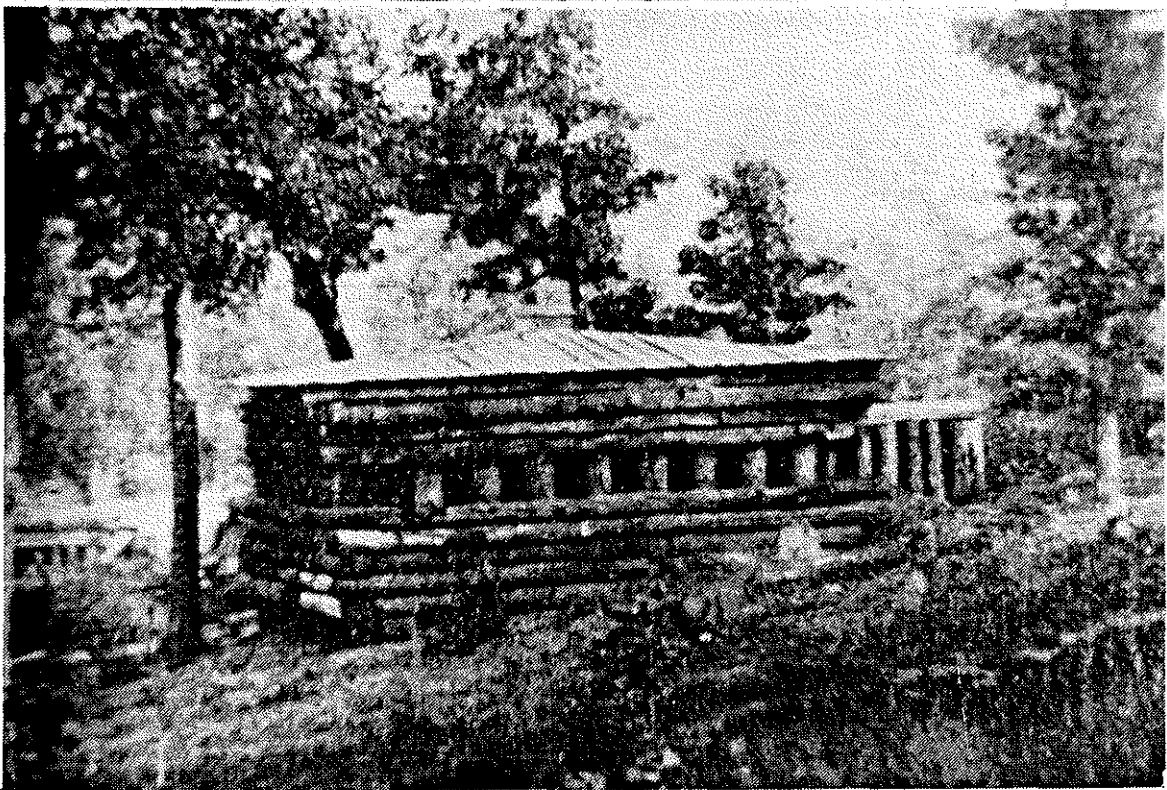
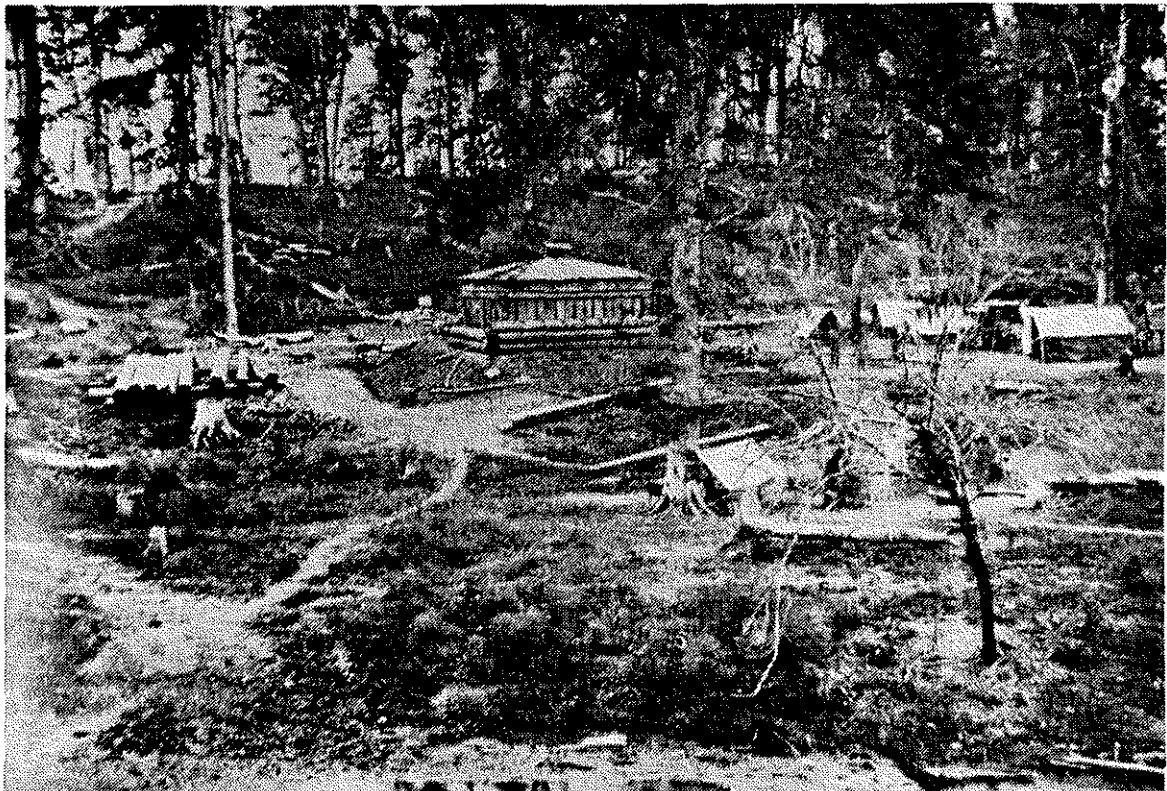

Figure 14. Two Civil War period photographs showing Union blockhouses typical of those built in the Middle Tennessee area and used in connection with railroad guard posts. Upper from Miller (1911: Vol. 4, p. 151); lower (ibid.: p. 149)

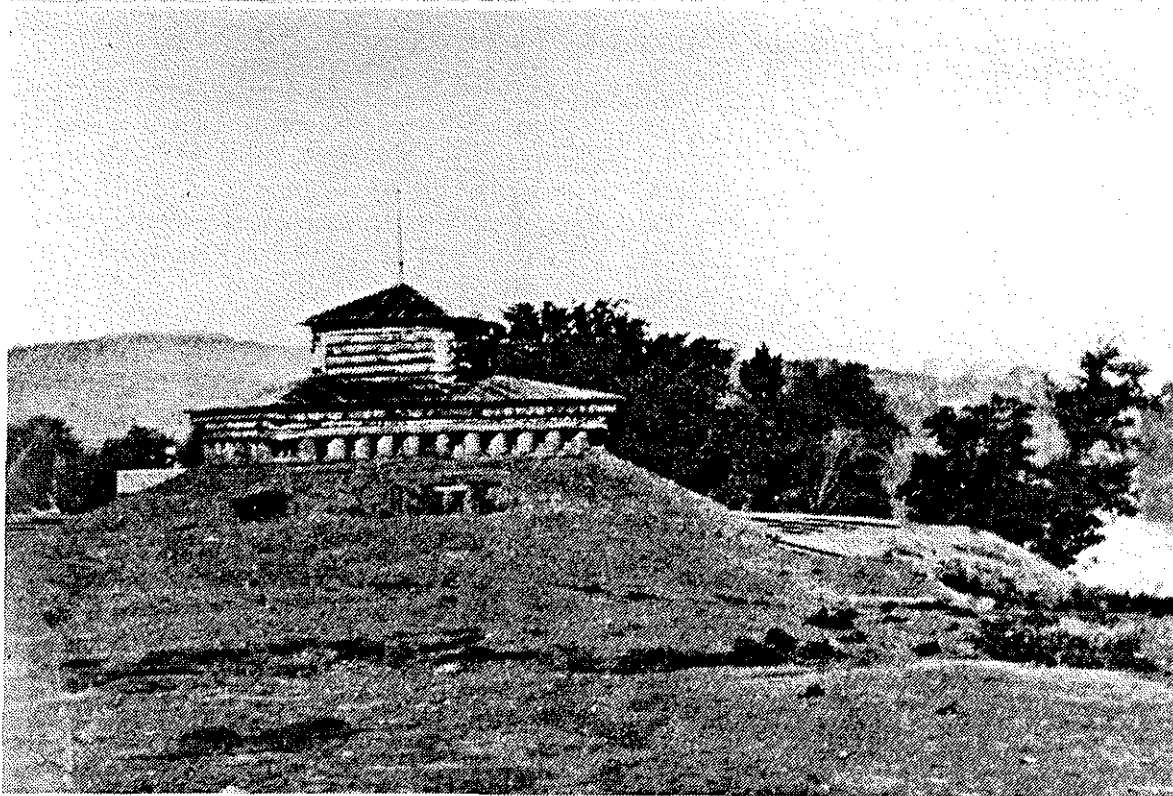
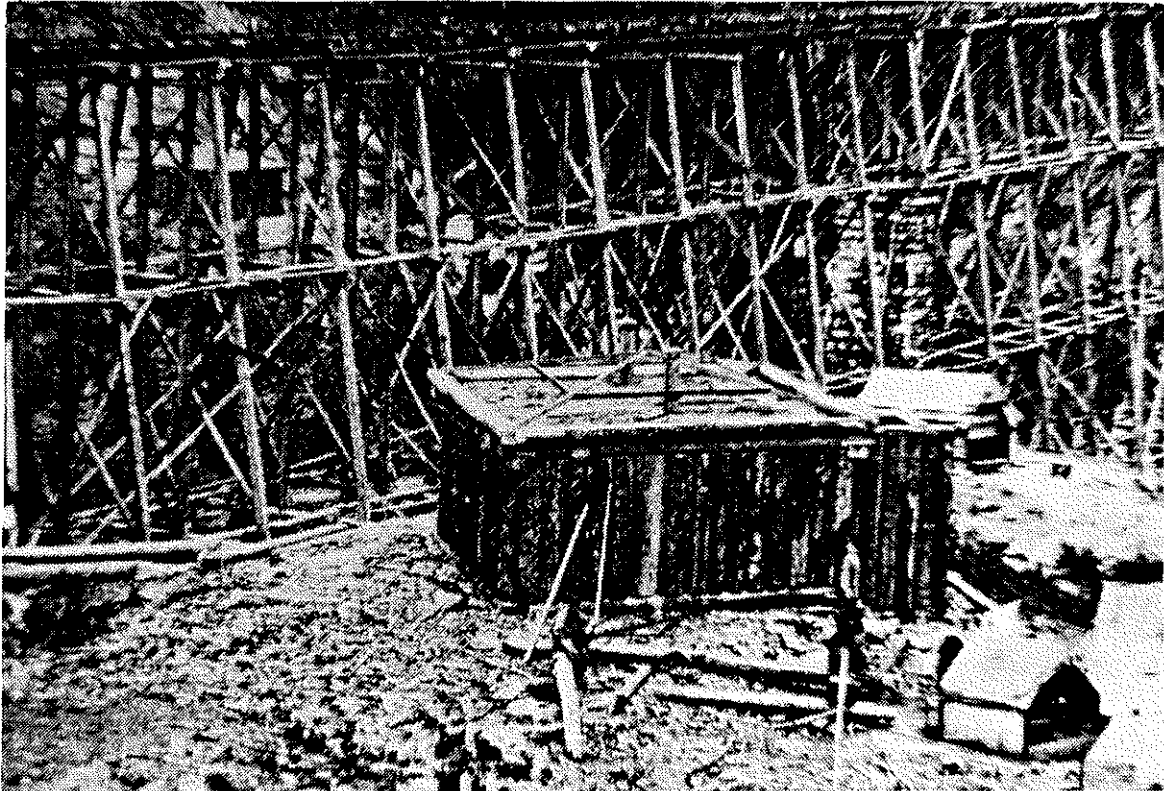

Figure 15. Additional Union blockhouse photographs. Upper showing a typical example undergoing construction (from Miller 1911: Vol. 2, p. 317); lower showing an example of a more elaborate type with a second story (from Davis 1982: 410).

Encampments:

Short-Term Encampment

Troops on the move often encamped for only one or a few nights in the same location. Numerous such short-term Civil War encampments existed in Middle Tennessee, but these would seldom if ever have produced any meaningful archaeological remains. Like Small Engagement Battlefields, recorded examples of this component are incidental to sites with other kinds of components.

Long-Term Encampment

A number of locations in Middle Tennessee served as places of encampment for troops for weeks, months, or even years. These long-term encampments have the potential for providing important archaeological information concerning the day to day life styles of the soldiers quartered here, including contrasts between Union and Confederate material remains. Two sketches showing Union encampments similar to some of those that were located in Middle Tennessee are shown in Figure 16.

Hospitals:

Short-Term Military Hospital

This refers both to buildings that were used as temporary or make-shift hospitals following a battle and tent hospitals, known as "brigade depots" or "forward dressing stations" (Chamberlin 1896: 418-428). The latter were located as close as possible to battle fronts, and the wounded from the field were brought here by stretcher bearers (who were detailed to accompany each regiment and carry off its wounded). Soldiers treated in these front-line hospitals were often placed in ambulance wagons and taken to larger field hospitals farther to the rear, called division hospitals. Some examples of short-term or field hospitals for the care of wounded Union soldiers are shown in Figure 17.

Long-Term Military Hospital

For the Federal troops engaged in battles, wounded soldiers from brigade depot or divisional hospitals were often next transported to "general hospitals," which were usually permanent buildings in larger cities (Dammann 1988: 26-28; Coggins 1962: 116). During the Middle Tennessee survey the name Long-Term Military Hospital was applied to "general hospitals," and all of the known Union examples are ones that were located in Nashville. Most of these are illustrated in Hoobler (1986). There was also a Federal Navy hospital ship (the D. A. January) that was used in the care of the wounded following the Battle of Nashville (Fig. 18). This steamship was later used to transport patients to Louisville or Cincinnati for further treatment (Durham 1987: 178). One long-term Confederate hospital was located in a building that is still standing in Tullahoma. Most of the recorded long-term hospital components (Table 1) relate to buildings that are still standing, a majority of which are listed on the National Register.

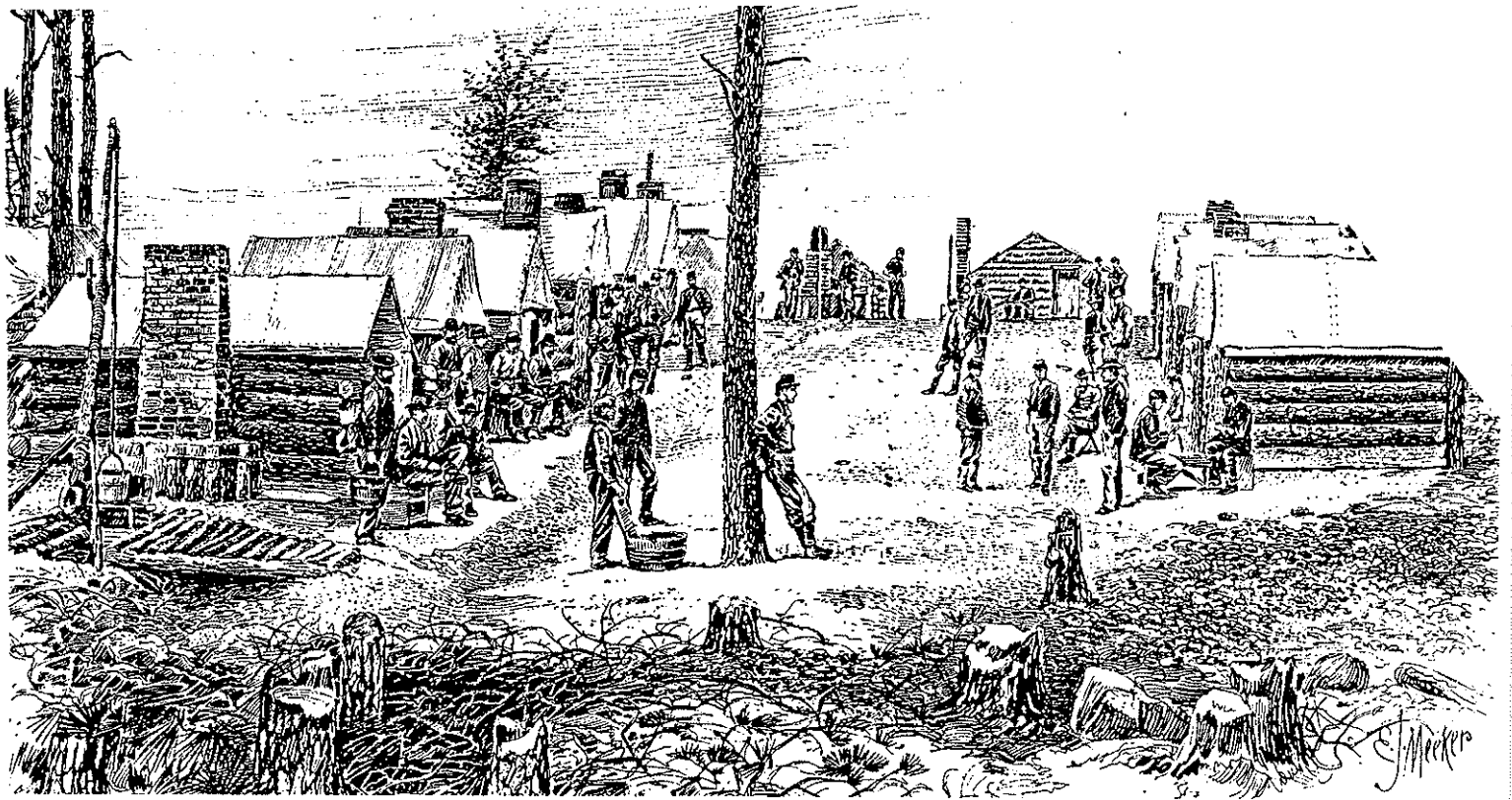

Figure 16. Illustrations of long-term encampments from Sears (1974: 220 and 154). Upper is entitled "Abandoning Winter Camp;" lower shows a similar encampment during use.

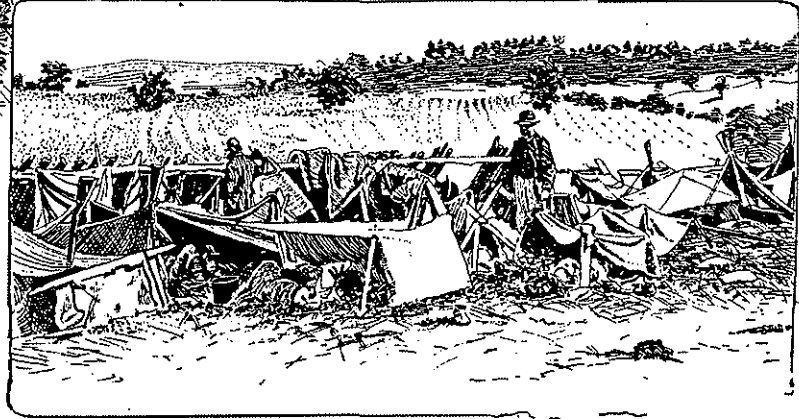
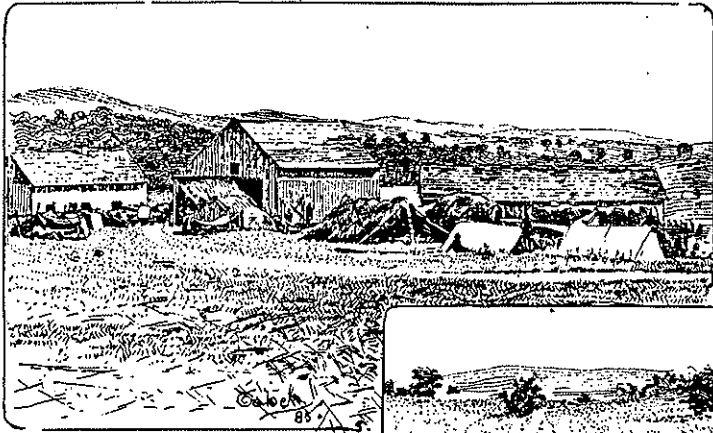

Figure 17. Illustrations of short-term or field hospitals (from Sears 1974: 166-167).

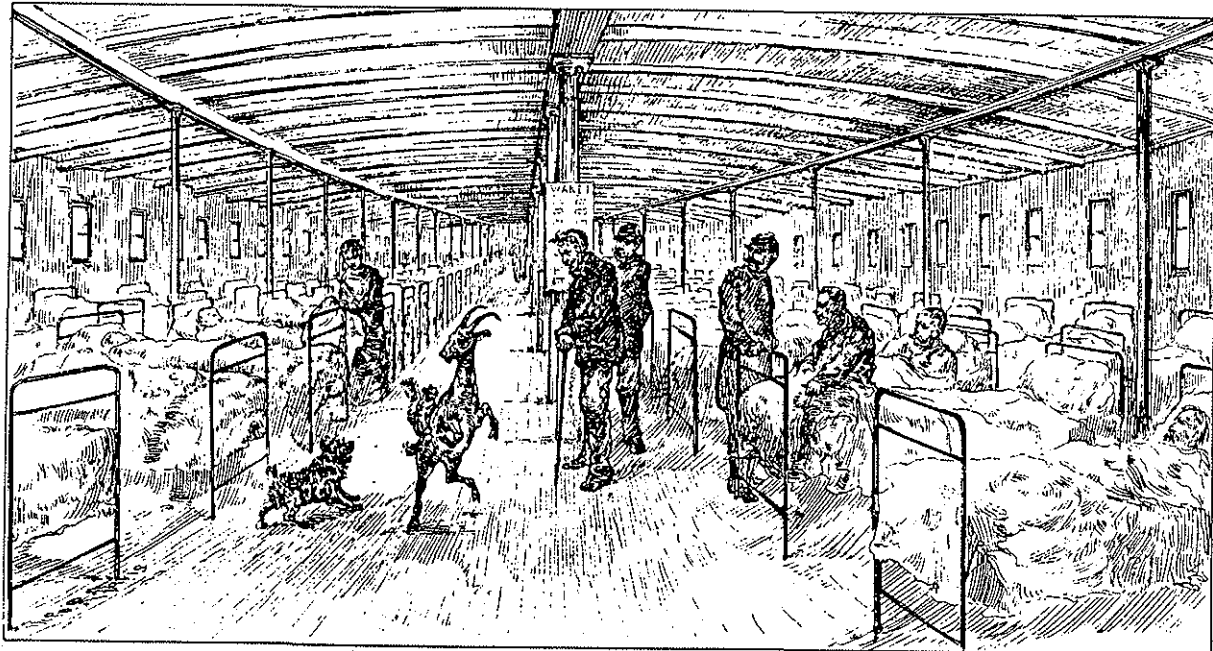
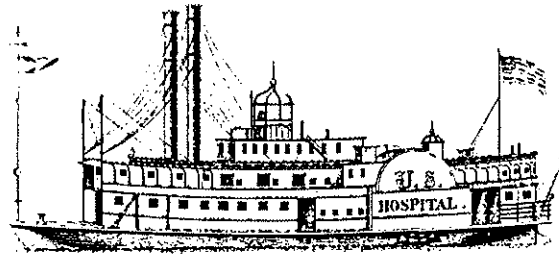
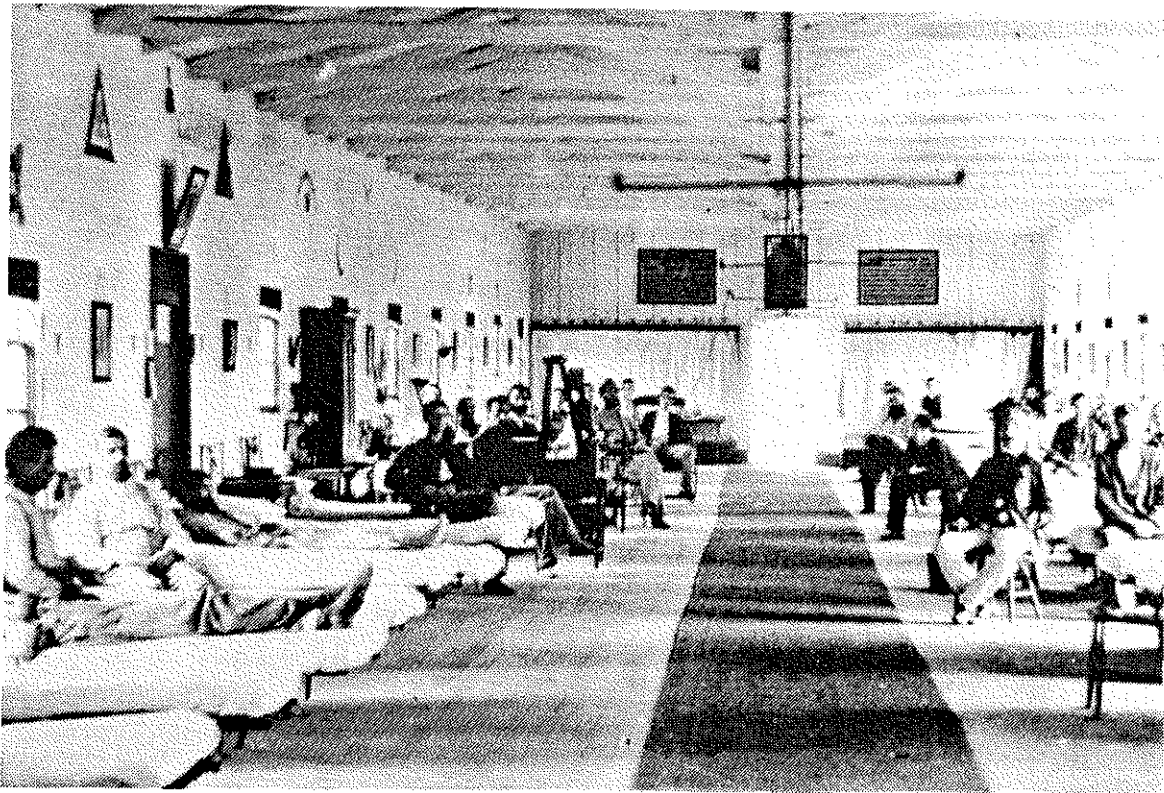

Figure 18. An interior photograph of a long-term Union hospital (from Davis 1983: 263) and two sketches of the U. S. hospital ship D. A. January (from Durham 1987: 178-179 and Sears 1974: 168).

Other Military Components Used in This Report:

Headquarters

During the survey this term was applied to sites with permanent buildings that were used by the commanding officers at the army, corps, or division levels. Such use of these buildings ranged from overnight to several months. Sites with headquarters buildings that were used for longer periods of time, are likely to contain significant archaeological information relating to this use, especially the associated encampment of supporting troops. Like Long-Term Hospitals, the components listed in Table 1 pertain to standing houses listed on the National Register.

Signal Station

Usually located on prominent hilltops, signal stations were set up to form an interlocking grid throughout the theater of war. Their primary function was to pass messages by semaphore ("wig wag"), but their localities also offered ideal views of enemy movements. Most of the signal station sites once contained wooden signal towers (Fig. 19) with some form of supporting defensive earthwork (Griffin 1986: 6). In a few cases strategically located existing buildings were occupied as signal stations. One such example was the Tennessee state capitol building in Nashville, which had a Union signal station in its cupola.

Other Components Used as Military Components in This Report

Military Shipyard

Civil War period military shipyards were designed for the building and maintenance of military vessels such as gunboats, transports, and barges. A single Federal military shipyard was located in Nashville on the bank of the Cumberland River (Table 1).

Military Foundry

Foundries were used for the manufacture of cast iron or other metal products. At least three foundries that existed in Nashville at the time of the Civil War were converted to military use for the production of artillery pieces, munitions, and other military equipment. Only one of these is still represented by a site that could be recorded (Table 1).

Military Railroad Depot

This term was used specifically in reference to a component of the Johnsonville site (Table 1), which during the Civil War was located at the end of the military railroad line from Nashville to the Tennessee River. Johnsonville's military "depot" was a collection of warehouses built by the Federal army for the storage of military supplies shipped up the Tennessee River for eventual transport to Nashville.

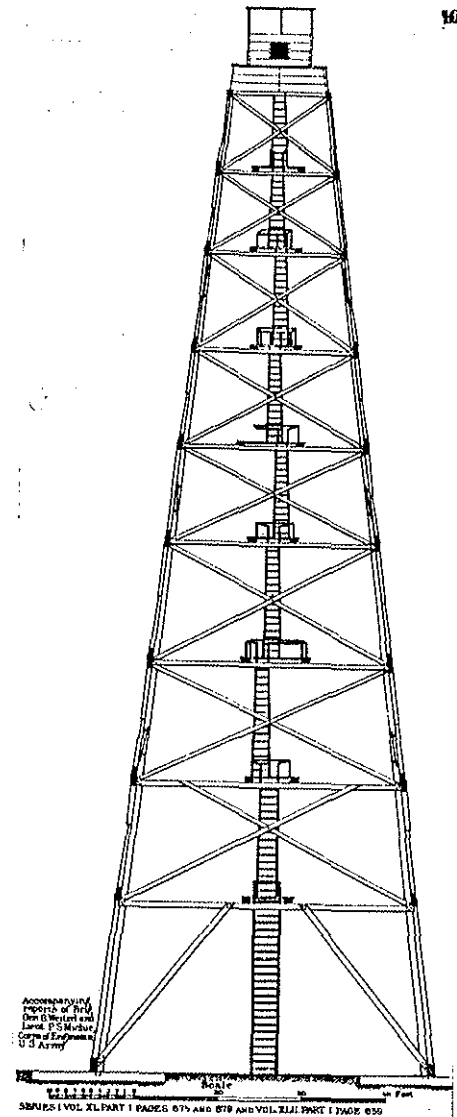
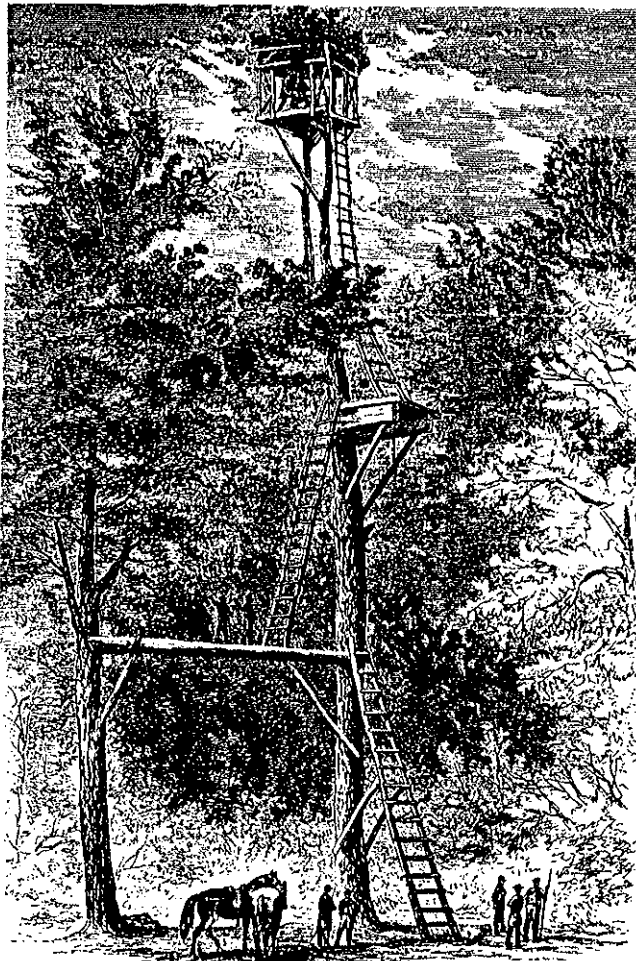
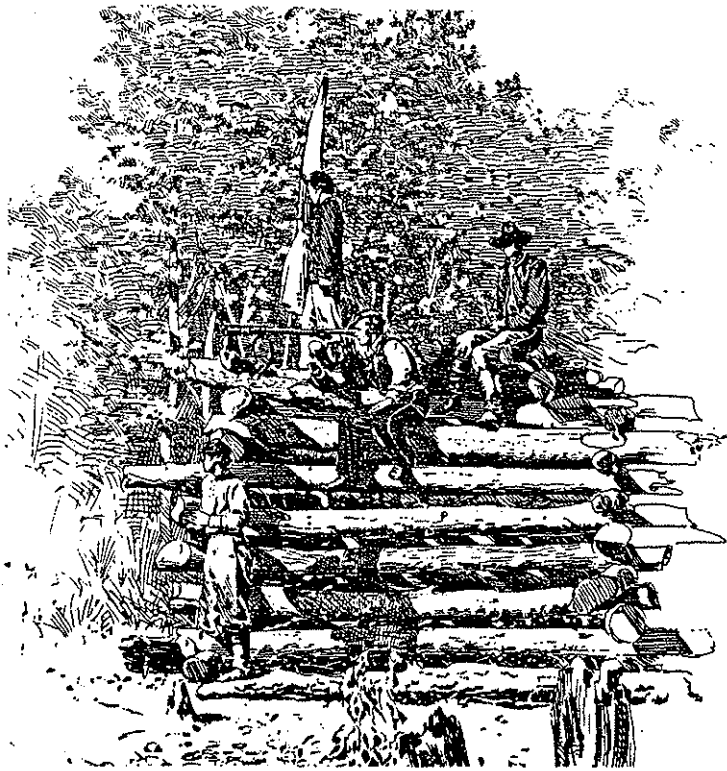

Figure 19. Examples of signal stations. Upper left (Sears 1974: 133); right (Davis et al. 1983: Plate LXVII, Fig. 10); lower left (Guernsey and Alden 1977: 697).

Military Historic Petroglyph

This component (Table 1) was used in recording a single example of carvings created on a natural rock in the vicinity of the Stones River Battlefield. Probably the work of stone masons associated with the 115th Ohio Volunteer Infantry, the carvings read: "J. C. Bauhof Co. B 115th OVI May 20, 1864" and "Daniel C. Miller Co. B 115 O.V.I."

Military Saltpeter Mine

The state-owned site known as Big Bone Cave contains several archaeological components, including remains relating to its use as a saltpeter mine operated by the Confederate army during 1861-1863 (Crothers 1986: 8). This was the only Civil War mining component (Table 1) identified during the Middle Tennessee survey.

CONCLUSIONS

The data collected during the 1988-1989 survey of Civil War period military sites in Middle Tennessee will no doubt be used in a variety of ways. The basic information that has been recorded concerning the frequency of types of sites (or "components") in this area (Table 1) provides answers to at least some of the questions previously discussed by Wright (1982: 1-3) relating to Civil War military engineering and the kinds of fortifications constructed. Having a preserved set of site records concerning this topic represents the fulfillment of an important goal in this era of continuing site destruction.

One of the expected uses of this report is as a "statement of context" (Smith 1990: 26-27) for the theme that was investigated. The information that is presented concerning Civil War period military sites in Middle Tennessee will be available for a variety of future site assessment needs. This can range from processes such as making suggestions for state or local acquisition for preservation of selected sites to the more common "review and compliance" activities carried out as part of the Federal Historic Preservation Program.

As the primary means used by the Federal Program for assessing site significance is the determination of what is referred to as "eligibility" for listing on the National Register (defined in National Park Service 1982: 28), an effort has been made as part of this survey project to examine each of the sites recorded in terms of their probable National Register eligibility. This is presented in the form of the following lists, which group sites according to four categories. A majority of the sites that are already on the National Register (Group I) are situations where the Civil War archaeological component(s) were incidental to the reasons for the original listing, which was usually made in reference to a standing historic building. In spite of the original intent, however, archaeological remains that are within National Register property boundaries should be given National Register protection status.

The next group (Group II) is composed of sites that, based on archival data and field survey information, are believed to be eligible for listing on the National Register. All of these sites appear to be in a relatively good state of preservation and are assumed to contain archaeological remains that have the potential for providing significant information about a particular type of Civil War period activity. The third group (Group III) is composed of sites that, due to survey conditions and lack of time for archaeological testing, could not be adequately assessed in terms of their potential for listing on the National Register. The major thing that would be needed to resolve whether individual sites in this group should actually be in Group II or Group IV is some amount of archaeological test excavation. The last category of sites (Group IV) includes ones that appear to have lost their archaeological integrity due to post-Civil War development or other site destructive activities. The placement of each site within this scheme should be regarded as a guide for future significance determination. In almost every individual case, it would be desirable to have archaeological excavation data before making a final significance determination.

Group I. Presently listed on the National Register:

Davidson County: 40DV11, 40DV59, 40DV189, 40DV369,
40DV371, 40DV373, 40DV375, 40DV376, 40DV377,
40DV378, 40DV398

Maury County: 40MU517

Montgomery: 40MT287

Stewart County: 40SW190

Williamson County: 40WM92, 40WM100, 40WM108, 40WM120,
40WM121, 40WM122, 40WM123, 40WM124

Group II. Probably Eligible for Listing on the National Register:

Bedford County: 40BD71, 40BD143, 40BD145, 40BD147,
40BD148, 40BD149, 40BD150

Cheatham County: 40CH157

Davidson County: 40DV61, 40DV388, 40DV392, 40DV397

Giles County: 40GL48, 40GL51, 40GL54

Humphreys County: 40HS157, 40HS180

Maury County: 40MU516

Robertson County: 40RB81

Rutherford County: 40RD176, 40RD184, 40RD187, 40RD188,
40RD193

Sumner County: 40SU103, 40SU104

VanBuren: 40VB103

Williamson County: 40WM101, 40WM102, 40WM106

Group III. Potential for National Register Listing Undetermined:

Bedford County: 40BD144, 40BD146, 40BD151, 40BD152,
40BD153, 40BD154, 40BD155, 40BD156, 40BD157,
40BD158

Cheatham County: 40CH153

Coffee County: 40CF225, 40CF226, 40CF227, 40CF228,

Davidson County: 40DV374, 40DV379, 40DV381, 40DV382,
40DV383, 40DV384, 40DV385, 40DV386, 40DV394,
40DV395

DeKalb County: 40DK38

Franklin County: 40FR178, 40FR181

Giles County: 40GL42, 40GL47, 40GL55

Humphreys County: 40HS177, 40HS178

Maury County: 40MU510, 40MU513

Rutherford County: 40RD177, 40RD179, 40RD180, 40RD181,
40RD182, 40RD183, 40RD185, 40RD189, 40RD190, 40RD192,
40RD194

Smith County: 40SM134

Stewart County: 40SW222

Sumner County: 40SU106, 40SU107, 40SU108

Warren County: 40WR34

Williamson County: 40WM105

Group IV. Probably Not Eligible for Listing on the National Register:

Cheatham County: 40CH154, 40CH155, 40CH156

Coffee County: 40CF212, 40CF229, 40CF230D

Davidson County: 40DV370, 40DV372, 40DV380, 40DV387,
40DV389, 40DV390, 40DV391, 40DV393, 40DV396

Dickson County: 40DS51

Franklin County: 40FR179, 40FR180

Giles County: 40GL49, 40GL50, 40GL52, 40GL53, 40GL56

Humphreys County: 40HS179

Maury County: 40MU511, 40MU512, 40MU514, 40MU515

Rutherford County: 40RD178, 40RD186, 40RD191

Stewart County: 40SW221

Sumner County: 40SU105

Williamson County: 40WM103, 40WM104, 40WM107

That there is a major lack of significant archaeological excavation data concerning Civil War period military sites in Tennessee is the most troublesome conclusion reached during the survey. This absence of data was apparent even before the survey was initiated, but it can now be seen in reference to how much information has been lost. No other historic period archaeological site category seems as threatened as Civil War period sites. Not only are they subject to the usual agents of site destruction (things such as private commercial and residential development, modern agricultural practices, or public construction projects such as highways and dams), but in addition they have undergone years of attack by a veritable army of specialized relic collectors. During the course of the 1988-1989 survey, virtually every site recorded appeared to have been subjected to at least some relic collecting activity.

The magnitude of this activity in Tennessee becomes obvious through an examination of any of the standard guides to collecting. For example, a recent issue of North South Trader's Civil War (Vol. XVII, No. 2, p. 48), one of the favorite magazines for Civil War relic collectors, contains a full page listing of dealers of metal detectors in a nine-state area. The state with the largest number of listings for such dealers is Tennessee.

The fact that the metal detector has been the standard "tool" for Civil War relic collecting, means that there is a heavy bias toward metal items in the published literature produced by those who have studied the results of this activity. Works such as Civil War Projectiles II (McKee and Mason 1980) or Confederate General Service Accoutrement Plates (Keim 1987), while highly specialized and scholarly studies, are, unfortunately, restricted in their information contents in ways probably not even apparent to their authors. These restrictions stem from the fact that the studies undertaken are almost entirely dependant on data collected by one single approach to artifact retrieval - artifacts dug out of their original context after being found with a metal detector, without any meaningful method or system for recording this context. A perusal of works such as Excavated Artifacts from Battlefields and Campsites of the Civil War (Phillips 1974 and 1980) or Civil War

Relics of the Western Campaigns (Harris 1987) would lead one to believe that the archaeological assemblages associated with Civil War period military sites are composed almost entirely of metal items.

Quite the contrary, our recent experience with salvage excavations at a Federal military encampment site in Middle Tennessee (see Acknowledgements) illustrates that the "garbage" produced by the soldiers of this time period was mostly in the form of broken pieces of glass and ceramic containers, common metal items such as nails, and discarded food remains. This last category is largely represented in the archaeological record by the bones of domestic animals. A study of faunal collections from these kinds of sites could yield a tremendous amount of information about the day-to-day life of the average soldier, but the vast literature that has been produced by the collectors of Civil War relics rarely even mentions such mundane items.

While, from an archaeological perspective, there is a major void in the information record that has been produced based on relic collecting, historical archaeologists have not been very active in the study of Civil War sites. The situation in Tennessee illustrates this rather clearly. As previously noted, this state was second only to Virginia in terms of the amount of Civil War activity that occurred, and it has been heavily "studied" by a variety of kinds of Civil War collectors (Tennessee site locations are mentioned about 100 times in Civil War Relics, Harris 1987: 254-256). By contrast, it is still relatively easy to list all of the archaeological reports that have been produced concerning Civil War remains in Tennessee. There are only six of them.

During the 1970s, test excavations were conducted at three Civil War forts: Fort Granger (Dilliplane 1975) in Williamson County; Fortress Rosecrans (Fox 1978) in Rutherford County; and Fort Pillow (Mainfort 1980) in West Tennessee. All of these projects were funded as a result of interest in developing the areas as public historic sites (this was only realized to any meaningful extent at Fort Pillow), and most of the work focused on investigating structural remains (earthworks) that contained relatively low densities of associated artifacts. More recently, two short reports have been produced documenting the archaeological testing of "Fort Germantown" near Memphis, Tennessee (G. Smith 1985 and 1987), which is again a project that has been carried out in response to a local reconstruction plan. The only archaeological projects concerning Civil War remains in Tennessee that have not focused on "forts" are ones that examined parts of the battlefields for the Battles of Nashville and Franklin. Both of these were archaeological mitigation projects carried out by the Division of Archaeology, and there is still not a completed final report for either (there is a preliminary report concerning the Nashville entrenchments, Kuttruff 1989). The results of each of these projects should be of considerable interest in that both clearly illustrate the sort of patterned distribution of Civil War remains that can be defined when an archaeological methodology is used.

There are a few other Tennessee archaeological site reports that contain some incidental discussion of Civil War artifacts (e.g., Hinshaw 1976: 108 and 113-118), but it is clear that archaeologists in Tennessee have yet to investigate any of the kinds of Civil War sites that would produce large amounts of artifactual data concerning this phase of the historic past. Some of the site types that were examined by the 1988-1989 survey are potentially of great interest due to the intensity of specialized activity that occurred at these locations. A particularly intriguing possibility concerns the sites of the blockhouses that were built in connection with railroad guard posts in Middle Tennessee. A few well preserved examples of these

sites remain, and they have the potential for providing some very interesting interpretations, linking an abundance of historic data with the kind of specific architectural and life-style information that carefully controlled archaeological excavations can provide.

Though exact information concerning how much work has been done on Civil War sites in other southern states is not readily available, the obvious absence of published archaeological reports indicates that Tennessee is not alone in its absence of archaeological data for Civil War period military sites. Though the activities of professional archaeologists are always limited by funding restrictions that may be beyond their immediate control, it would appear that the reason that so little archaeology has been conducted on Civil War period sites has been to a large extent a matter of choice. It seems probable that the idea of carrying out studies of Civil War sites and artifacts has been rather intimidating to most archaeologists. While their training and philosophy prevent them from being able to condone the relic collector's methods of collection, there is a simultaneous recognition that some of these same collectors are true authorities in their fields. It would take the average archaeologist years of study to become equally competent to identify some of these same specialized artifact categories.

What is obviously needed is some compromise whereby some of the enthusiasm and work that has been put into relic collecting could be directed toward the archaeological goals of scientific information retrieval, classification, and artifact distribution studies. The experiences of this survey have indicated that there are numerous knowledgeable and dedicated individuals who study the Civil War and its remains for their own pleasure who would be willing to assist with any research that they feel would add significantly to the body of known information concerning this particular topic. It is incumbent on the archaeological community to take the initiative in soliciting help from these same individuals, just as it is clear that the need for clearly recorded and preserved information about the various types of Civil War sites needs to be a matter of archaeological concern. The more time that elapses before a major effort is made to collect meaningful archaeological excavation data concerning the various types of sites that exist, the more complete will become the level of site destruction. As with any major archaeological research goal, an adequate study of Civil War period military sites can only be completed if ways are found to fund the basic research needed.

Closely related to the need for scientifically collected archaeological data is the need for an appropriate amount of archival research. An effort that has been ongoing for the past few years to better understand early nineteenth-century military sites in Tennessee (Smith 1985; Smith and Rogers 1989) has revealed that there is a tremendous volume of Federal military information housed at the National Archives that has been largely unused by other investigators (e.g., Record Group 92, Records of the Office of the Quartermaster General, contains 22,942 cubic feet of records and Record Group 94, Records of the Adjutant General's Office, contains 38,107 cubic feet of records - the major portion of both of these record groups are neither indexed nor microfilmed). These same record groups cover the Civil War period and contain information that is potentially directly relevant to understanding any of the individual sites in the Middle Tennessee area. It was also learned during the course of the Middle Tennessee survey that a surprisingly large number of Civil War archival groups exist at some of the public and university libraries in Tennessee, and that these have likewise not been systematically examined for the information that they might provide for the interpretation of specific Tennessee sites. The completion of a coordinated project of data collection focusing on both

archival materials and archaeological site investigations would not be an easy goal to complete, but attention should be given to such a possibility as soon as possible.

To restate the major conclusions derived from the 1988-1989 survey, there were 143 Civil War period military "sites" found in Middle Tennessee that were still sufficiently intact to allow them to be recorded by the survey, but about 25 percent of these appear to have been damaged to the extent that they have no remaining archaeological potential. Most of the remaining 75 percent have also suffered some degree of adverse impact due to years of unrecorded, private relic collecting activities, but the extent of damage from this is difficult to clearly assess without archaeological excavation data from specific sites. What is clear is that the number of well preserved Civil War period military sites in this area has steadily declined in modern times, and this trend can be expected to continue until they approach extinction (with only those sites that are publicly owned remaining). This continuing loss of data was the inspiration for conducting a survey of this class of historic period archaeological sites, and it should now provide part of the inspiration for finding ways to carry out archaeological excavation of some of the few remaining sites that are still relatively well preserved and serve to represent the types known to exist. Only if such data are collected in the near future is there any likelihood of preserving a significant amount of the archaeological information that relates to these kinds of sites, which are as important to our understanding of the past as any other category of historic period remains.

REFERENCES CITED

- Adams, George R. and Ralph J. Christian
n.d. Nashville A Pictorial History (no date of publication given). The Donning Company, Virginia Beach.
- Albaugh, William A.
1960 Confederate Edged Weapons. Harper and Brothers, New York.
- Brandon, Helen Gould
1944 A History of Stewart County Tennessee. M. A. Thesis, University of Tennessee, Knoxville.
- Brown, Norman D. (editor)
1980 One of Cleburne's Command, The Civil War Reminiscences and Diary of Capt. Samuel T. Foster, Granbury's Texas Brigade, CSA. University of Texas Press, Austin.
- Caldwell, Mary Frence
1968 Tennessee the Volunteer State. Richtext Press, Chicago.
- Chamberlin, W. H.
1896 Sketches of War History 1861-1865, Vol. IV. The Robert Clark Company, Cincinnati.
- Coggins, Jack
1962 Arms and Equipment of the Civil War. Doubleday and Company, Inc. New York.
- Crothers, George M.
1986 Final Report on the Survey and Assessment of the Prehistoric and Historic Archaeological Remains in Big Bone Cave, Van Buren County, Tennessee. Department of Anthropology, University of Tennessee, Knoxville.
- Dammann, Gordon
1988 Pictorial Encyclopedia of Civil War Medical Instruments and Equipment, Vol. II. Pictorial Histories Publishing Company, Missoula, Montana.
- Daniel, Larry J. and Riley W. Gunter
1977 Confederate Cannon Foundries. Pioneer Press, Union City, Tennessee.
- Davis, William C. (editor)
1981 Shadows of the Storm. The Image of War 1861-1865, Vol. 1. Doubleday & Company, Inc., Garden City, New York.
1982 The Guns of '62. The Image of War 1861-1865, Vol. 2. Doubleday & Company, Inc., Garden City, New York.
1983 Fighting for Time. The Image of War 1861-1865, Vol. 4. Doubleday & Company, Inc., Garden City, New York.

- Davis, George B., Leslie J. Perry, and Joseph W. Kirkley
 1983 The Official Military Atlas of the Civil War (originally published in 1891). The Fairfax Press, New York.
- Dilliplane, Timothy L.
 1966 Exploratory Excavations at Fort Granger. Printed for limited distribution by the Franklin, Tennessee, Jaycees with assistance from the National Park Service.
- Durham, Walter T.
 1985 Nashville, The Occupied City. The Tennessee Historical Society, Nashville.
 1987 Reluctant Partners, Nashville and the Union. The Tennessee Historical Society, Nashville.
- Dyer, Frederick Henry
 1908 A Compendium of the War of the Rebellion, Vol. I. Thomas Yoseloff, Inc., New York.
- Fox, Steven J.
 1978 Archaeology of Fortress Rosecrans: A Civil War Garrison in Middle Tennessee. Prepared for National Park Service, Tennessee Historical Commission, and City of Murfreesboro, Tennessee.
- Fremantle, Lieut.-Col.
 1863 Three Months in the Southern States, April-June 1863. William Blackwood and Sons, London.
- Garrett, Jill Knight
 1963 A History of Humphreys County, Tennessee. Privately Published.
- Griffith, Paddy
 1986 Battle in the Civil War. Fieldbooks, Mansfield, Nottinghamshire, England.
- Guernsey, Alfred H. and Henry M. Alden
 1977 Harpers Pictorial Histroy of the Civil War. Fairfax Press.
- Harris, Charles S.
 1987 Civil War Relics of the Western Campaigns 1861-1865. Rapidan Press, Mechanicsville, Virginia.
- Higgs, David W.
 1976 Nathan Bedford Forrest and the Battle of Johnsonville. Tennessee Historical Commission, Nashville.
- Hill, Richard Taylor and William Edward Anthony
 1978 Confederate Longarms and Pistols. Published by the authors, Charlotte, North Carolina.
- Hinshaw, Jane
 1976 Sevier Park: Eighteenth Century Trading Post or Nineteenth Century Settlement? M.A. Thesis, Vanderbilt University, Nashville.

- Hoobler, James A.
 1986 Cities Under the Gun, Images of Occupied Nashville and Chattanooga. Rutledge Hill Press, Nashville.
- Horn, Stanley F.
 1956 The Decisive Battle of Nashville. University of Tennessee Press, Knoxville.
 1987 The Army of Tennessee. Broadfoot Publishing Company, Wilmington, North Carolina.
- Horn, Stanley F. and other members of the Civil War Centennial Commission
 1977 Guide to the Civil War in Tennessee. Civil War Centennial Commission, Nashville, Tennessee.
- Hughes, Nathaniel C. (editor)
 1985 Liddell's Record, St. John Richardson Liddell, Brigadier General, CSA, Staff Officer and Brigade Commander, Army of the Tennessee. Morningside House, Inc., Dayton, Ohio.
- Johnson, Robert Underwood and Clarence Clough Buel (editors)
 1956 The Way to Appomattox. Battles and Leaders of the Civil War. Castle Books, New York.
- Jordan, Leland
 1935 Triune in the Civil War. Leland Jordan Papers, III-C-6, Box 1, Folder 9, Tennessee State Library and Archives, Nashville.
- Keim, Lon W.
 1987 Confederate General Service Accoutrement Plates. Moss Publications, Orange, Virginia.
- Kelley, James C.
 1989 Civil War Drawings from the Tennessee State Museum. Tennessee State Museum Foundation, Nashville.
- Ketchum, Richard M. (editor)
 1960 The American Heritage Picture History of the Civil War. American Heritage Publishing Co., Inc., New York.
- Kuttruff, Carl
 1989 Excavations on Confederate Entrenchments, Nashville, Tennessee. Paper presented at the Joint Archaeological Congress, Baltimore, Maryland.
- Logsdon, David R. (compiler and editor)
 1988 Eyewitnesses at the Battle of Franklin. Published by the compiler, Nashville.
- Luther, Edward T.
 1977 Our Restless Earth, The Geologic Regions of Tennessee The University of Tennessee Press, Knoxville.

Mahan, D. H.

- 1836 A Complete Treatise on Field Fortifications, with the General Outlines of the Principles Regulating the Arrangement, the Attack, and the Defence of Permanent Works. Wiley and Long (1968 reprinting by Greenwood Press, New York).

Mainford, Robert C.

- 1980 Archaeological Investigations at Fort Pillow State Historic Area: 1976-1978. Research Series No. 4, Tennessee Division of Archaeology, Nashville.

McDonough, James Lee

- 1977 Shiloh - in Hell Before Night. The University of Tennessee Press, Knoxville.

McDonough, James Lee and Thomas L. Connelly

- 1983 Five Tragic Hours. The Battle of Franklin. The University of Tennessee Press, Knoxville.

McKee, W. Reid and M. E. Mason, Jr.

- 1980 Civil War Projectiles II, Small Arms & Field Artillery. Moss Publications, Orange, Virginia.

Merrill, William E.

- 1875 Block-houses, etc., The Engineering Service in the Army of the Cumberland. In History of the Army of the Cumberland, Vol. II, pp. 439-458, by Thomas B. Van Horne (1875b).

Miller, Francis Trevelyan

- 1911 The Photographic History of the Civil War, Volumes 1-10. The Review of Reviews Co., New York.

National Park Service

- 1982 How to Apply the National Register Criteria for Evaluation (Draft). National Park Service, Department of the Interior, June 1, 1982, Washington, D. C.

OR (1880-1901)

The War of the Rebellion: A Compilation of the Official Records of the Union and Confederate Armies. Government Printing Office, Washington, D. C.

Phillips, Stanley S.

- 1974 Excavated Artifacts from Battlefields and Campsites of the Civil War 1861-1865. LithoCrafters, Inc., Ann Arbor, Michigan.

- 1980 Excavated Artifacts from Battlefields and Campsites of the Civil War 1861-1865 Supplement I. S. S. Phillips and Assc., Lanham, Maryland.

Purdue, Howell and Elizabeth Purdue

- 1973 Pat Cleburn, Confederate General. Hill Jr. College Press, Hillsboro, Texas.

- Ridley, Bromfield L.
 1978 Battles and Sketches of the Army of Tennessee (originally published 1906). Morningside Bookshop, Dayton, Ohio.
- Riley, Harris D., Jr.
 1989 A Gallant Adopted Son of Tennessee - General John C. Carter, C.S.A. Tennessee Historical Quarterly, Vol. XLVIII, No. 4, pp. 195-208. Tennessee Historical Society, Nashville.
- Ripley, Warren
 1970 Artillery and Ammunition of the Civil War. Van Nostrand Reinhold Company, New York.
- Reilly, Robert M.
 1970 United States Military Small Arms 1816-1865, the Federal Firearms of the Civil War. The Eagle Press, Inc.
- Scofield, Levi T.
 1909 The Retreat from Pulaski to Nashville, Tenn., Battle of Franklin, Tennessee, November 30th, 1864. Press of the Caxton Co., Cleveland.
- Scott, Colonel H. L.
 1864 Military Dictionary. D. Van Nostrand, New York.
- Sears, Stephen W.
 1974 The American Heritage Century Collection of Civil War Art. American Heritage Publishing Co., Inc., New York.
- Smith, Gerald P.
 1985 Fort Germantown Historic Park; Historic Background, Archaeological Investigations, and Recommendations. Prepared for the City of Germantown, Tennessee.
 1987 Fort Germantown: 1986 Excavations. Prepared for the City of Germantown, Tennessee.
- Smith, Samuel D.
 1985 Fort Southwest Point Archaeology Project: Interim Report. Tennessee Division of Archaeology, Nashville.
 1990 Site Survey as a Method for Determining Historic Site Significance. Historical Archaeology, Vol. 24, No. 2, pp. 26-33. The Society for Historical Archaeology.
- Smith, Samuel D. and Stephen T. Rogers
 1979 A Survey of Historic Pottery Making in Tennessee. Research Series No. 3, Tennessee Division of Archaeology, Nashville.
 1989 Historical Information Concerning the Fort Blount-Williamsburg Site, Jackson County, Tennessee. Report of Investigations No. 6, Tennessee Division of Archaeology, Nashville.

- Smith, Samuel D., Charles P. Stripling, and James M. Brannon
1988 A Cultural Resource Survey of Tennessee's Western Highland Rim Iron Industry, 1790s - 1930s. Research Series No. 8, Division of Archaeology, Nashville.
- Sunderland, Glenn W.
1984 Wilder's Lightning Brigade ... And Its Spencer Repeaters. The Book Works (TM), Washington, Illinois.
- Sword, Wiley
1983 Shiloh: Bloody April. Morningside Bookshop, Dayton Ohio.
- Todd, Frederick P.
1983 American Military Equipage, 1851-1872, Vol II. Chatham Square Press.
- Van Horne, Thomas B.
1875a History of the Army of the Cumberland Its Organization, Campaigns, and Battles, Vol. 1. Robert Clarke & Co., Cincinnati.

1875b History of the Army of the Cumberland Its Organization, Campaigns, and Battles, Vol. 2. Robert Clarke & Co., Cincinnati.
- Wright, David R.
1982 Civil War Field Fortifications, An Analysis of Theory and Practical Application. M.A. Thesis, Middle Tennessee State University, Murfreesboro.
- Wyeth, John A.
1975 Life of General Nathan Bedford Forrest. Morningside Bookshop, Dayton, Ohio.

APPENDIX A

**Glossary of Civil War Period Military Terms
Relating to Middle Tennessee Sites.**

Abatis:

Rows of felled trees with the smaller branches removed and the remaining branches sharpened to create an obstacle to an advancing enemy (Scott 1864: 9). Illustrated in Figure 3.

Banquette:

A step at the base of a parapet on which a soldier could stand and fire over the parapet (Wright 1982: 323); (Fig. 4).

Banquette Slope:

An access ramp to the Banquette (Wright 1982: 323); (Fig. 4).

Bastion:

A projection from a main work containing two faces and two flanks that provide flanking fire to the front of the main work (Scott 1864: 81); (Fig. 6).

Bastion Fort:

A polygonal work with bastions at the corners eliminating all dead spaces and angles; (Fig. 6).

Battlefield: (see text)

Berm:

A narrow shelf between the exterior slope and the scarp which prevented the parapet from collapsing into the ditch (Ripley 1970: 249); (Fig. 4).

Blockhouse: (see text)

Breastwork: (see Entrenchment)

Counterscarp:

The exterior slope of the ditch below the glacis (Ripley 1970: 249); (Fig. 4).

Covered Way:

A narrow walkway between the counterscarp and the glacis along which troops could move concealed from view of the enemy (Wright 1982: 325); (Fig. 4).

Dead Angle or Space:

An area in front of a fortification that cannot be covered by musket or artillery fire (Wright 1982: 325).

Detached Works:

Fortifications constructed beyond the musketry range of the main works. These works were part of the overall defenses of the main work (Scott 1864: 236).

Ditch:

An excavation made in front or behind an earthwork providing the earth for that work. The ditch can serve as an obstacle to an attacker or a secure place for a defender (Scott 1864: 247). Both types are shown in Figure 3.

Embrasure:

An opening in a parapet wall through which an artillery piece or other weapon could be fired (Scott 1864: 255); (Fig. 4).

Encampment: (see text)

Entrenchment: (see text)

Exterior Slope:

The outer slope of the parapet facing the enemy. The exterior slope extended from the superior slope to the berm (Wright 1982: 327); (Fig. 4).

Fascine:

A long, cylindrical bundle of thin saplings and twigs used for sustaining the steep slopes of a trench (Scott 1864: 283); illustration is from Scott (1864: Fig. 178) and shows a fascine resting on farming trestles, which were used during the manufacturing process.

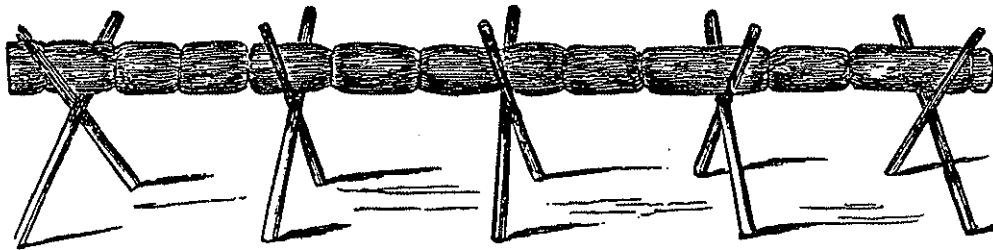

Fort: (see text)

Gabion:

An open-end basket woven from twigs and small branches which was filled with dirt and used to support interior slopes (Ripley 1970: 250) or, as in the illustration (from Sears 1974: 312), to form free-standing defensive works.



Glacis:

A gentle slope on the opposite side of the ditch from the rampart. This slope eliminated dead spaces and protected the scarp from bombardment (Wright 1982: 329); (Fig. 4).

Head Log:

Logs placed horizontally on top of an earthwork and raised three to four inches above that work so that a soldier could fire a rifle through the opening without exposing his head to fire (Griffith 1986: 35); (Fig.3).

Headquarters: (see text)

Hurdle:

A wicker or woven sapling wall, 3 to 4 feet high and 6 to 9 feet long, constructed between two upright poles. Hurdles were used as revetments (Scott 1864: 508); illustration from Scott (1864: Fig. 184).

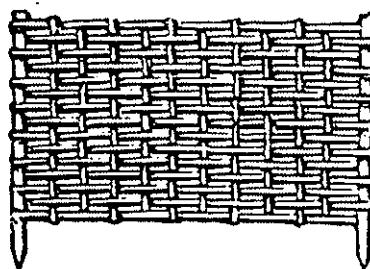

Interior Slope:

The angle extending between the superior slope and the banquette (Ripley 1970: 249); (Fig. 4).

Loopholes:

A small opening in a wall through which a weapon could be fired (Scott 1864: 394); illustration taken from Blockhouse Sketch No. 2 (1864) by Colonel William E. Merrill (Buell-Brein Papers, Tennessee State Library and Archives).

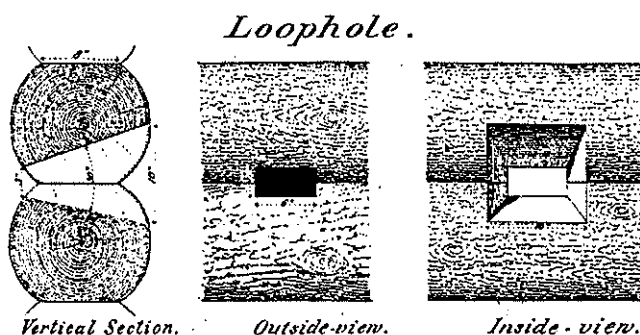

Lunette: (see text)

Military Foundary: (see text)

Military Hospital: (see text)

Military Railroad Depot: (see text)

Military Saltpeter Mine: (see text)

Military Shipyard: (see text)

Palisade:

Pointed stakes placed in the ground at an angle facing the enemy. The stakes were 6 to 8 inches in diameter and 6 to 10 feet long, and they were usually placed in front of a ditch as an obstacle (Fig. 3); illustration from Scott (1864: Fig. 170).

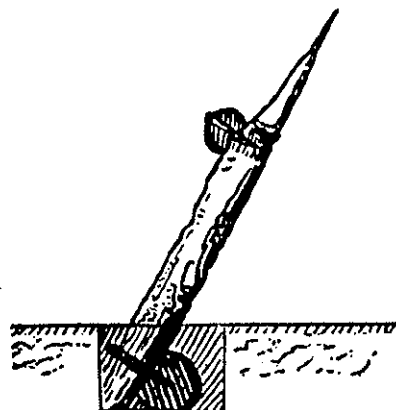

Parapet:

A wall behind which troops stand to defend a fortified position (Ripley 1970: 248); the defensive wall placed on top of a rampart (Fig. 4).

Priest-Cap: (see text)

Railroad Guard Post: (see text)

Rampart:

A broad wall or embankment forming the main body of a fortification and supporting a parapet on its exterior edge (Scott 1864: 483-484); (Fig. 4).

Redan: (see text)

Redoubt: (see text)

Revetment:

Material used to sustain an embankment, such as wood, stone, sandbags, sod, gabions, or fascines (Ripley 1970: 249); illustration from Scott (1864: Fig. 181) shows a slope revetted with horizontally placed fascines.

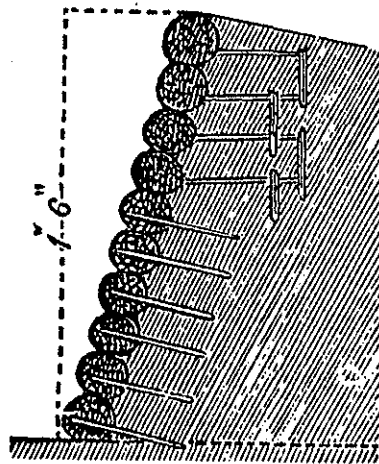

Scarp:

The inner slope of the ditch under the berm (Ripley 1970: 249); (Fig. 4).

Signal Station: (see text)

Stockade: (see text)

Superior Slope:

The top of the parapet extending from the interior slope to the exterior slope (Wright 1982: 333); (Fig. 4).

Terreplein:

The level space between the banquette slope and the interior slope of a rampart (Ripley 1970: 248); (Fig. 4).

Traverse:

An earthen wall or embankment perpendicular to the main rampart wall. The traverse provided protection from enfilading fire (Wright 1982: 333); (Fig. 6).

Tread:

The top platform of the banquette (Ripley 1970: 249); (Fig. 4).